



Department of
Building and Housing
Te Tari Kaupapa Whare

External moisture – An introduction to weathertightness design principles



Foreword

Some people in the building sector favour a performance-based approach to building, stating the objectives and leaving industry to attend to the solutions. Others want more guidance in the form of ready-made solutions. The Acceptable Solution for Building Code Clause E2 External Moisture, E2/AS1, is intended as a ready-made solution, and does not preclude the use of other performance-based designs.

While ready-made solutions may be useful for those wanting instant answers to instant problems, in the long-term they do little to encourage innovation. For innovation to happen, a more fundamental understanding of the principles behind the solutions is required. Understanding the principles enables a designer to manage their own solutions to any number of weathertightness design and detailing problems. It also assists building officials and surveyors when considering a design's compliance with the Building Code, and helps builders and installers when constructing buildings and their component parts.

The prescriptive solutions in E2/AS1 should now be providing improvements in new building work, but are only a start towards achieving fundamental changes in industry performance. Initiatives introduced by the Building Act will lead to the transformation of the sector – and to better outcomes for New Zealanders. They range from licensing building practitioners and accrediting building consent authorities (councils), to better protections for homeowners through mandatory warranties for building work. In addition, the Building Code is being reviewed to ensure more clarity on the standards we expect for our buildings, and to introduce more guidance on how those standards can be met.

Leaks are involved in a majority of building failures, and avoiding rain damage can be one of the most difficult tasks designers and builders face. This document provides more guidance on how to construct buildings that are weathertight. It will play a part in more buildings being built properly first time, ensuring more New Zealanders have access to quality homes that are well built, safe and healthy.



John Kay

General Manager, Building Controls
Department of Building and Housing

PURPOSE OF THIS DOCUMENT 5

Audience for this document 5

INTRODUCTION 6

Principle-based thinking 6

Practical steps 8

Weathertightness in the New Zealand Building Code 8

PART A PRINCIPLES OF WEATHERTIGHTNESS 9

1 The New Zealand environment 9

- a) Wind and rain **9**
- b) Temperature changes **9**
- c) Movement: wind and earthquake **10**
- d) Wetting and drying **10**
- e) Salt-laden air **10**
- f) Ultraviolet light **10**
- g) Other cladding requirements **11**

2 Moisture movement 11

- a) Gravity **11**
- b) Momentum **12**
- c) Pressure differentials **12**
- d) Surface tension **13**
- e) Capillary attraction **14**
- f) Airborne moisture (convection) **14**
- g) Vapour diffusion **14**
- h) Condensation **15**
- i) Solar-driven moisture **16**

3 Cladding principles 16

- a) Traditional approach **16**
- b) The 4Ds approach **17**

PART B WEATHERTIGHTNESS PRINCIPLES APPLIED 22

1 Wall-cladding systems 22

- a) Mass wall systems **22**
- b) Barrier systems **23**
- c) Rainscreen systems **23**
- d) Pressure-equalised rainscreens **26**

2 Wall-cladding joints 26

- a) Horizontal joints **27**
- b) Vertical joints **28**
- c) Sealed joints **29**
- d) Cladding absorbency and texture **30**

3 Roof claddings 31

- a) The 4Ds in roof design **31**

4 Floors 34

- a) Floor levels **34**
- b) Timber-framed floors **35**
- c) Slab-on-ground **35**

5 Retaining walls 36

- a) Retaining wall/slab **36**
- b) Separate inner wall **37**
- c) Retaining wall with raised timber floor **37**
- d) Retaining wall with double wall and timber floor **38**

GLOSSARY 39

APPENDIX A: STEPS IN THE DESIGN PROCESS 41

APPENDIX B: SIMPLE EXAMPLE 42

APPENDIX C: ADDITIONAL RESOURCES 44

LIST OF FIGURES

- Figure 1: Solutions in the design **7**
- Figure 2: Weathertightness in the Building Code **8**
- Figure 3: New Zealand's conditions **9**
- Figure 4: Gravity leaks **11**
- Figure 5: Momentum leaks **12**
- Figure 6: Pressure differentials **13**
- Figure 7: Water droplets **13**
- Figure 8: Surface tension **13**
- Figure 9: Capillary attraction **14**
- Figure 10: Interstitial condensation **15**
- Figure 11: Solar-driven moisture **16**
- Figure 12: Two lines of defence **16**
- Figure 13: The 4Ds approach to weathertightness **18**
- Figure 14: Deflection **19**
- Figure 15: Limits to deflection **20**
- Figure 16: Drainage **20**
- Figure 17: Drying **21**
- Figure 18: Types of wall **22**
- Figure 19: Types of cavity **24**
- Figure 20: Pressure moderation **24**
- Figure 21: E2/AS1 drained cavity **25**
- Figure 22: Horizontal joint **26**
- Figure 23: Vertical joint **26**
- Figure 24: Horizontal joints **27**
- Figure 25: Anti-capillary separation **27**
- Figure 26: Vertical joints **28**
- Figure 27: Drained joint **29**
- Figure 28: Sealant joints **29**
- Figure 29: Cladding surfaces and vertical joints **30**
- Figure 30: Positioning of roof penetrations **31**
- Figure 31: Roof deflection **31**
- Figure 32: Adequate clearances **34**
- Figure 33: Floor levels related to site **35**
- Figure 34: Timber-framed floors **35**
- Figure 35: Concrete slab-on-ground **35**
- Figure 36: Wall/slab **36**
- Figure 37: Double wall with cavity **37**
- Figure 38: Retaining wall with raised floor **37**
- Figure 39: Double wall and double floor **38**
- Figure 40: Weathertightness in the design process **41**

Purpose of this document

External moisture – An introduction to weathertightness design principles (the guide) provides a clear explanation of the basis on which good weathertight buildings can be constructed in New Zealand.

It is not intended as a prescriptive 'how to' guide. The aim is to help you understand the principles behind constructing weathertight buildings and to provide information on where to seek further details. Ultimately, it helps you use this understanding and knowledge for designing, evaluating or building specific 'performance-based' solutions (alternative solutions) for yourself.

The information in the guide is divided into two broad sections.

- **Part A – Principles of weathertightness.**
This section introduces the primary physical influences affecting joints and claddings that effective cladding systems must be designed and built to resist.
- **Part B – Weathertightness principles applied.**
This section builds on the weathertightness principle of Part A to explain how some common cladding types can manage physical forces in ways that provide effective weather-resisting systems.

Audience for this document

The primary intention for this guide is to provide a common source of information so that issues of weathertightness can be discussed on the basis of common knowledge and understanding during design, approval and construction of a building. It will be useful for:

- **designers** during the design and detailing of building projects
- **building officials and surveyors** when considering consent applications, inspecting buildings during construction and assessing completed buildings for Building Code compliance
- **builders and installers** when constructing buildings and their component parts.

The guide should also be useful for:

- **educators** when teaching issues related to weathertightness
- **manufacturers and suppliers** when designing, manufacturing or assessing products and components that add to a building's weathertightness.

The guide may also be of interest to:

- **researchers** when researching issues related to weathertightness
- **building managers and owners** when considering maintenance issues and repairs relating to weathertightness
- **developers, project managers and quantity surveyors** when planning and developing building proposals
- **insurers** when assessing potential risks of future or existing buildings
- **financiers and investors** when balancing risks and rewards of financial participation in future or existing buildings
- **town planners** when assessing implications of planning restrictions, such as site coverage and boundary conditions, on the weathertightness of future buildings.

Introduction

Achieving a weathertight building envelope is a matter of managing water. During a building's lifetime there will inevitably be some moisture penetration. Therefore the envelope must not only be effective at limiting water penetration, but also be able to cope with unexpected water entry. Water can be further managed by first limiting the amount of rain that strikes outer surfaces, and then by safely dissipating any moisture that gets beyond the claddings.

Acceptable Solution E2/AS1 provides a limited set of prescriptive design solutions, but many projects may require designs, claddings and details outside the scope of E2/AS1. When alternatives to E2/AS1 solutions are developed, their weathertightness must be based on an understanding of moisture behaviour. The key is to ensure a deeper understanding of the principles behind the prescriptive design solutions.

This guide provides a basic understanding of approaches to weathertightness and introduces fundamental principles to help when developing, assessing and building specific solutions for specific situations and problems. The guide provides a checklist for designers, building officials and others to use in considering all the risks of water entry appropriate to a particular site or building design.

Principle-based thinking

Solutions in the design

Without understanding weathertightness principles, a designer is restricted to a limited number of prescribed details and may also fail to appreciate the subtle relationship between an overall building design and the detailing necessary to achieve a weathertight building envelope.

Early design

An example of early thought in the design process is the use of roof overhangs or other water-deflecting devices to limit the amount of water cascading down a wall or over a joint to reduce the chances of that joint leaking.

Where joints are not protected in this way, total weatherproofing must be achieved at the joint, requiring a much higher order of joint design.

An experienced designer understands that designing for weathertightness begins long before considering the construction details.

Remember that the first reason for building is to provide shelter from the weather. This reason should still be a primary consideration when siting, shaping and selecting materials for a building.

Decisions made at the conceptual design stage can reduce the amount of water (the 'moisture load') that has to be handled when detailing individual joints and junctions later in the design process. Effective weathertightness design results from a combination of thoughtful overall building design and the careful detailing of individual joints.

While the design process involves a balancing of various aspects of design (during which 'trade-off' decisions are made), there are some simple aims (see Figure 1).

Figure 1: Solutions in the design

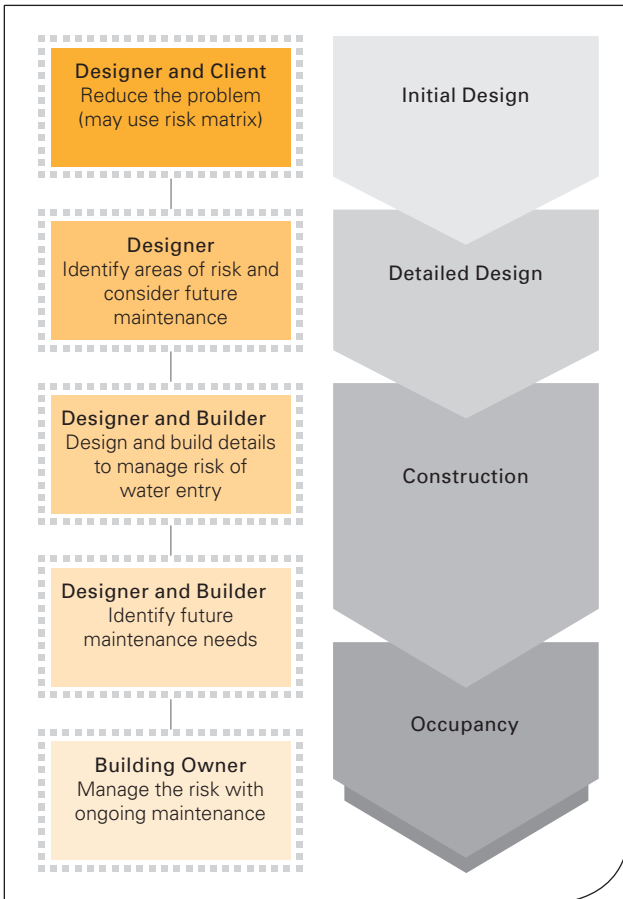

Reduce the problem

Reducing or controlling the moisture load is the first, and most important, step in designing to minimise the risk of rainwater penetration. This involves assessing risk (see the box opposite) and exploring with clients measures to reduce that risk, by carefully considering the building shape, height and orientation, the number and positioning of penetrations, and particularly risky design features.

Identify the remaining problem

Once possible reductions in the moisture load have been explored and addressed, remaining problem areas in a design need to be identified. Associated risks must be recognised and carefully considered to allow the investigation of protective measures.

Handle the problem

Once risky areas are identified and understood, workable, robust and long-lasting details must be developed that effectively manage the risk of water penetration for a particular design on a particular site.

Continue to handle the problem

The job is not complete when construction is complete. The building envelope must continue to manage the risk of water penetration during a building’s life. Designers and builders must recognise the importance of maintenance to the durability of materials. They should identify what areas rely on maintenance for preserving weathertightness, and ensure this is possible and practical.

There is little point in providing a junction that relies on a coating being regularly maintained if the junction is, for example, impossible to access by a homeowner or if the homeowner does not understand the importance of regular ‘normal’ maintenance.

Assess the risk

Factors such as wind, extreme height, roof overhangs, building shape and other features, such as balconies, are identified in E2/AS1.

The risk matrix can be used as a tool to assess and potentially reduce the overall weathertightness risk of a building design by allowing incorporation of design features that can compensate for some of those risks.

Also consider site risks such as:

- wind strength and prevailing direction
- expected rain intensity and direction
- influential topographic features.

Practical steps

How to use this guide

A flowchart showing where information in this guide fits within a 'weathertightness design process' is provided for reference in Figure 41.

By using the information contained in this guide, there are practical steps a designer can take to bring weathertightness into the design process. However, we cannot offer a 'solution by numbers', with a 'right' answer at the end.

The process is more subjective, relying on experience on the part of the designer in the art and science of building. It is also cyclical, and a designer should be prepared to revisit general design decisions if detailing proves too complex or risky.

Weathertightness in the New Zealand Building Code

The Building Code sets out objectives, functional requirements and performance requirements for all buildings; how these are met is up to an individual building owner and their designer.

The Department issues Compliance Documents containing 'Acceptable Solutions' and 'Verification Methods'. These provide prescribed solutions and methods that are deemed to comply with the Building Code. If designed and built properly, a building consent authority must accept these solutions and methods.

However, following Compliance Documents is only one way of complying with the Building Code. Designers can choose to use a different method.

This guide aims to provide a better understanding of the principles underlying the E2/AS1 details, which can be tools to use when considering other ways of designing buildings to meet Clause E2 of the Building Code.

Figure 2: Weathertightness in the Building Code

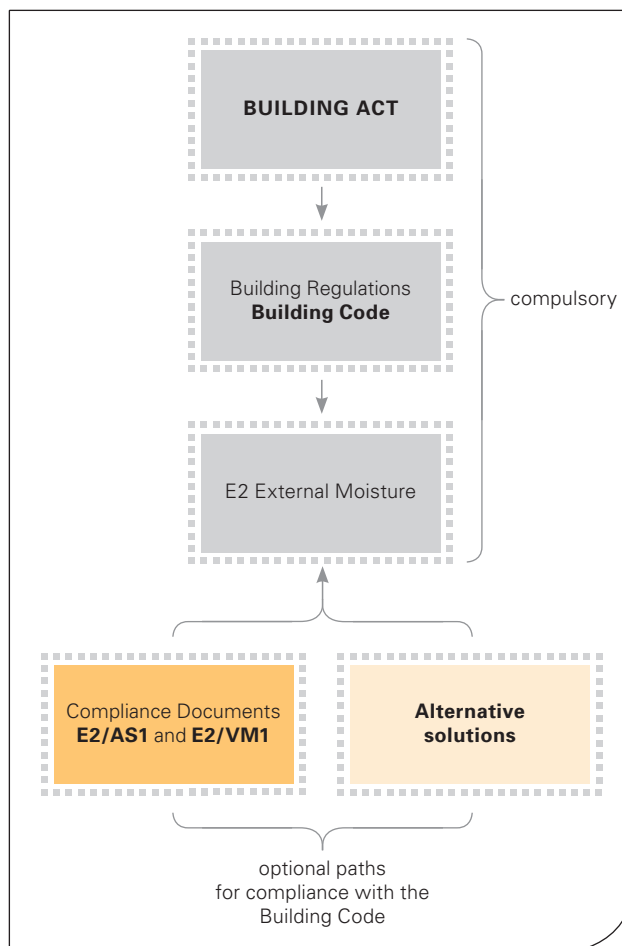

In contrast to Acceptable Solutions, performance-based (alternative) solutions are subject to acceptance by building consent authorities. They must be satisfied, on reasonable grounds, that any building application meets the objectives, functional requirements and performance requirements of the Building Code.

Scope of E2/AS1

The Compliance Documents outline 'acceptable' methods of complying with Clause E2 of the Building Code for buildings within the scope of E2/AS1 and E2/VM1.

For buildings outside the scope of E2/AS1 and E2/VM1, there is no option but to use a performance-based means of compliance.

Part A: Principles of weathertightness

Part A sets out the particular conditions we face in New Zealand, outlines the mechanisms by which water acts on claddings and cladding joints, and then outlines the overall design principles for weathertightness.¹

1 The New Zealand environment

Understanding our weather is the first step in designing to keep water out. New Zealand lies in the temperate zone of the southern hemisphere. Our wind, rain and sunshine may make us a world-class food producer, but they also combine to provide a particular set of conditions to cope with when designing for weathertightness.

Some countries have similar climates, while others have similar building techniques, but none has exactly the same combination of conditions as New Zealand.

We may learn from the way in which solutions to similar problems are developing in North America, but we must adapt and develop our own weathertightness solutions to suit our own particular set of problems.

Our own mix

Environmental conditions are just one component within New Zealand's particular mix of factors that affect buildings. Others include lifestyle preferences and design fashions, building types, town planning, building materials, trade skills, construction costs and social expectations. All of these interact to affect the chances of a building being built to resist leaking.

Figure 3: New Zealand's conditions

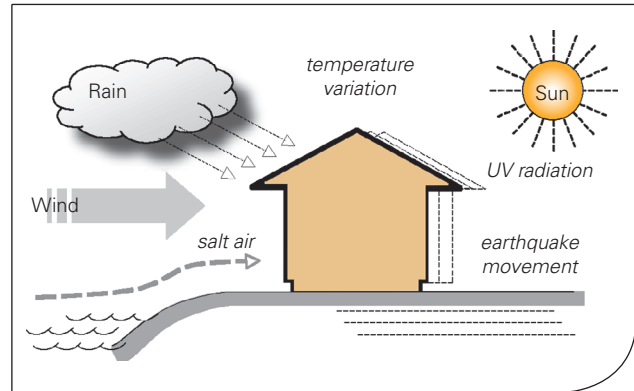

a) Wind and rain

New Zealand lies across the path of the prevailing westerlies known as the 'roaring forties', so rain is often accompanied by wind. However, rain from other directions is frequently more damaging (eg, north-easterlies in Auckland and on the east coast, or southerlies in Wellington and Christchurch).

Most of our settlements are concentrated near the coast with changeable weather patterns, high levels of humidity, and strong winds often accompanied by rain.

Managing wind-blown rain

Use overlaps and overhangs to deflect rain from vulnerable areas.

b) Temperature changes

While we may not have the extremes of temperature that are experienced in some other parts of the world, our temperatures can fluctuate rapidly, sometimes several times in a day.

Temperature variations lead to movement in claddings, and constant expansion and contraction may cause stresses in some claddings. Building details must allow for this in order to avoid cracking and consequential water entry.

¹ Small grey 'tip' boxes are provided as prompts throughout Part A, some of which are explored further in subsequent sections. Additional resources for more detailed guidance are listed in Appendix D.

Managing temperature movement

Install movement control joints to allow for expansion and contraction of materials, especially metal claddings and exposed flashings.

c) Movement: wind and earthquake

Our landmasses are subject to frequent low levels of earth tremor with an occasional severe shaking from larger earthquakes.

Seismic stress on cladding joints can be accommodated with control joints and overlaps. These allow joint components to move independently, preventing joints cracking or tearing apart during stress-inducing movement from forces such as earthquakes, wind, ground settlement, temperature changes and wetting/drying cycles.

Movement

Unless a drained cavity is used, avoid using monolithic claddings on building structures (such as pole frame or perimeter pile foundations) that are subject to localised movement or settlement.

d) Wetting and drying

In the context of our climate and construction methods, it is inevitable that moisture will occasionally penetrate claddings and be absorbed into wall materials. This must be handled in such a way as to allow effective drainage and drying before deterioration.

Prolonged periods of wet weather can cause dampness within construction materials. In time, after periods of fine weather, these materials will eventually dry out naturally.

The effects of these wetting and drying cycles are important, particularly for light timber-frame construction. If drying is inhibited, moisture may build up within walls and eventually cause deterioration.

In saying that a building can 'stay dry', we are really saying that it will meet the durability requirements of the Building Code, and stay dry long enough to prevent materials rotting or rusting.

The interior of a building must also stay dry enough to prevent inhabitants becoming ill from the toxic effects of mould and mildew. While the effects of moisture inside a building result mainly from internally generated moisture, moisture penetration from outside can add to dampness.

Managing wetting and drying

Make allowance for dimensional changes and movement of timber framing, such as allowing for shrinkage of floor joists.

Claddings with many joints, such as weatherboards and roof tiles, allow better natural drying of the structure than membrane or monolithic claddings.

e) Salt-laden air

Nowhere in New Zealand is far from the coast and most urban settlement is near the coast. Therefore many buildings are exposed to the effects of salt-laden air.

Salt, in the presence of moisture, is especially corrosive to steel building materials. While steel claddings (and exposed steel structures) require protective coatings, it is the continuing maintenance of these that will determine their durable life, long-term performance and ability to resist water entry.

Effective maintenance procedures involve regular washing with water to remove salt build-up. Where claddings are exposed to regular washing by rain, the speed of corrosion slows. Where surfaces are exposed to the outside atmosphere, but protected from rain wetting, corrosion is accelerated.

Managing salty air

Claddings (particularly metal) exposed to salt-laden air will corrode faster when they are sheltered from natural rain washing and are not washed regularly as part of maintenance. An example of this is unprotected metal soffits.

f) Ultraviolet light

New Zealand's atmosphere is relatively clean and clear of influences that filter ultraviolet (UV) light, further exacerbated by changes in atmospheric ozone levels.

As a result, cladding and jointing materials can therefore be exposed to high levels of UV, which will dry and prematurely degrade bituminous products, polymers, sealants and protective paint coatings.

Managing UV rays

Sealants that form part of weather-resisting systems should be protected from exposure to direct sunlight.

g) Other cladding requirements

Most of our houses have timber structures, so our claddings must protect the framing.

As there will probably be occasions when claddings leak, the Acceptable Solution B2/AS1 for Clause B2 Durability requires exterior framing to have levels of durability that will delay deterioration until leaks are detected and fixed.

To comply with the Building Code, claddings also need to meet other Code requirements. These requirements must all be incorporated to ensure the primary functions of protecting the framing along with the health and safety of the inhabitants are achieved.

Claddings in the Building Code

Functional requirements of claddings are covered in Clauses:

- B1 Structure
- B2 Durability
- C3 Spread of Fire
- E1 Surface Water
- E2 External Moisture
- E3 Internal Moisture
- F3 Hazardous Building Materials
- G4 Ventilation
- G5 Interior Environment
- G6 Airborne and Impact Sound
- H1 Energy Efficiency.

2 Moisture movement

To effectively weatherproof our buildings, we need to understand how and why water behaves as it does. The following outlines common mechanisms (both physical forces and effects) that act on a cladding and its joints. Unless these are taken into account in the design, a building will be vulnerable to moisture penetration.

Water entry

Any properly designed joint must be able to resist all of the mechanisms of moisture movement described here, which are not mutually exclusive.

One mechanism will act in combination with one or more of the others.

a) Gravity

Two important points to remember are that gravity acts:

- downwards
- all of the time.

These qualities should make gravity-induced water movement easy to predict. However, gravity remains a common cause of water entry, due mainly to poor design and workmanship. Also, water may enter by one (or a combination) of the other mechanisms, with gravity then taking over to exacerbate the effect. Even minor defects in the building envelope can allow considerable quantities of water to penetrate.

Figure 4: Gravity leaks

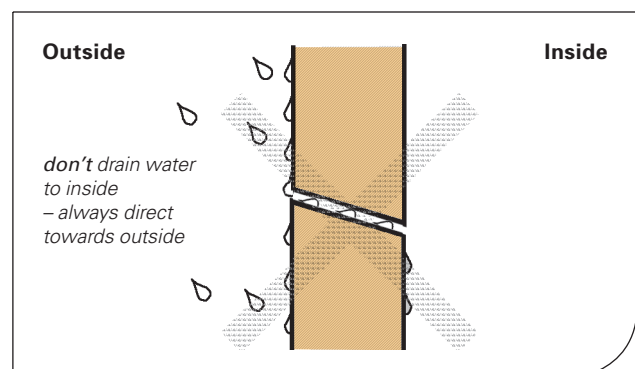

For low-rise buildings, gravity leaks are usually more of a problem than wind-induced leaks, in contrast to high-rise buildings where wind pressures tend to dominate.

Managing gravity

Many leaks are simple gravity leaks. Protection is needed in the form of flashings, drainage slopes, adequate overlaps, and limiting penetrations through horizontal components.

b) Momentum

Raindrops are moved by the wind but do not always follow the wind, as water is far denser than air. So while wind can easily deflect around a building, raindrops are more likely to impact on the building envelope when carried by high winds.

Once rainwater hits a wall, it forms a film and begins to flow downwards under gravity. Wind flowing over the surface will deflect this flow, and will force water sideways and even upwards.

A wind-driven raindrop can hit a surface with a force sufficient to drive it past the outer defences of a joint or cladding, as shown in Figure 5(a).

Raindrops can also bounce, resulting in water travelling upwards, and momentum can carry water deep into joints as shown in Figure 5(b).

Managing momentum

Protection can be provided by ensuring water is separated or deflected away from vulnerable zones.

This may be achieved by using clearance separation, screening junctions and diverting water away from junctions.

Figure 5: Momentum leaks

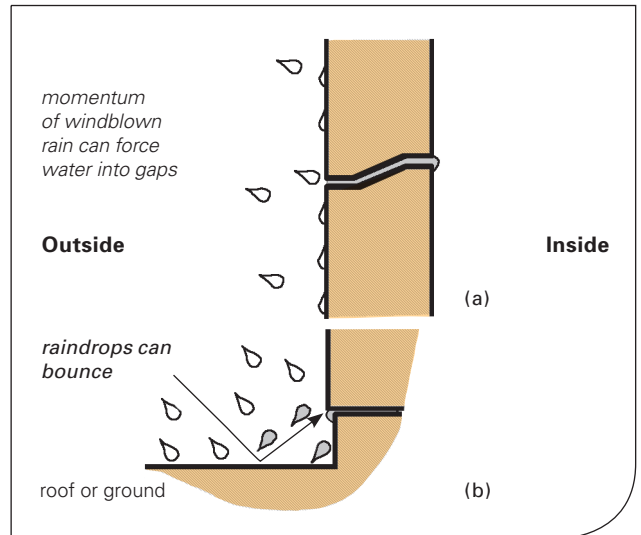

c) Pressure differentials

When wind blows against the surface of a wall, it creates a higher air pressure on the outside (windward) than on the inside where pressure is lower.

Air will try to equalise this difference by flowing from the higher to lower pressure zone.

This means that air will move through any gap to balance the pressure differential, as shown in Figure 6. If there is wind and rain, then air will carry water with it as it moves through gaps in the wall, resulting in leaks.

Managing pressure differentials

Protection against moisture movement resulting from a pressure differential can be provided by using air seals and wind barriers on the dry side of a wall, away from the wet outer side. Preventing airflow through the wall will stop moisture from being 'sucked' from the wet side of the wall.

Figure 6: Pressure differentials

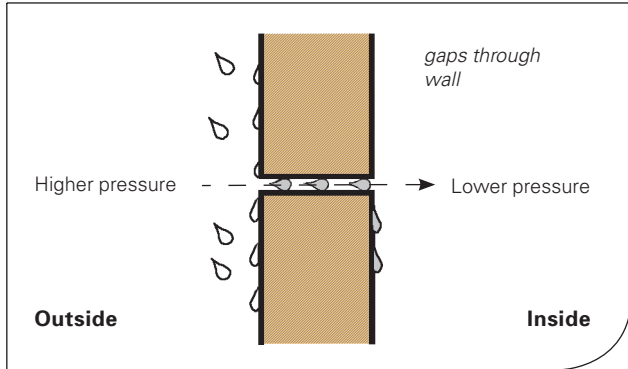

d) Surface tension

Surface tension (or molecular attraction) is the reason that raindrops and water droplets are shaped as they are. A water molecule is polar (positively charged at one end and negative at the other), which allows molecules to loosely bond together.

When a drop of water comes into contact with a material, it may be attracted to the surface. If this attraction is strong enough, the drop may be able to resist gravity and adhere beneath horizontal surfaces as shown in Figure 7(a).

Figure 7: Water droplets

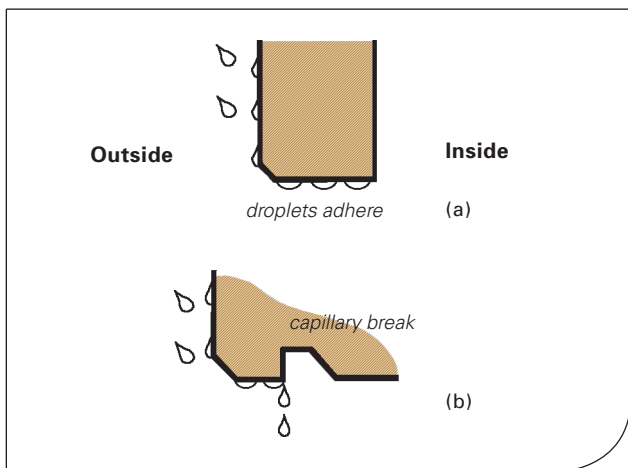

Hydrogen bonding – the H bond

The oxygen atom is negative while hydrogen is positive, causing attraction known as hydrogen (H) bonding. This influences the physical properties of water, including the effect of surface tension.

In a free-falling drop of water (ignoring air resistance), H bonding pulls the drop into a sphere. The outer molecules are H-bonded inwards, creating the 'skin' effect of surface tension.

Different building materials have different attractions for water. On surfaces with a low attraction to water, drops 'bead' up with a high contact angle as shown in Figure 8(a). Examples are most metals, new paint coatings, glass and water-repellent treatments like wax (cleanliness will also affect attraction).

On surfaces with a strong attraction to water, drops flatten out with a low contact angle as shown in Figure 8(b). Examples are weathered paint, bare timber, paper and unsealed fibre cement, plaster or concrete.

Figure 8: Surface tension

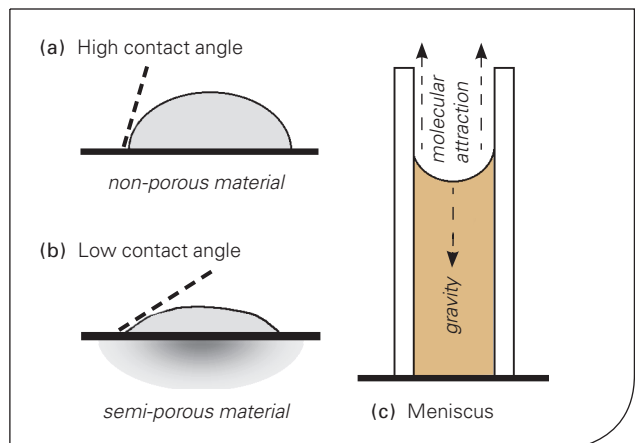

Managing raindrops

Capillary breaks, as shown in Figure 7(b), along with drip edges can be used to prevent water from migrating across soffit surfaces. See overleaf for other capillary movement.

e) Capillary attraction

Surface tension causes capillary attraction, allowing water to pass through very small gaps or cracks.

If water is held between two parallel surfaces, it is pulled up at the edges forming a 'meniscus' as shown in Figure 8(c). This attraction pulls water into the gap until the tension upwards in the meniscus balances downwards gravity pull. Capillary height depends on the gap and how attractive the surfaces are to water.

The height to which water is drawn by capillary attraction increases as the gap decreases, leading to the type of capillary force that allows porous materials to absorb water or carries water through very small cracks or junction gaps, as shown in Figure 9(b).

Minute gaps inside porous materials allow capillary forces to 'pull' moisture into the material, as shown in Figure 9(a). This absorption or 'wicking' allows water to move considerable distances, including upwards against gravity.

The main influences on capillary movement are gap width and water source.

Figure 9: Capillary attraction

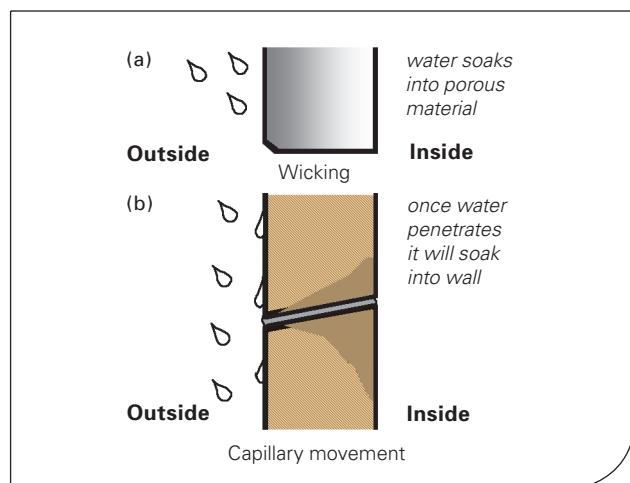

Managing capillary movement

Protect against capillary movement by providing capillary gaps, rebates, kick-outs or drip edges at critical points in capillary paths. Examples of these are shown in Figures 25 and 26.

f) Airborne moisture (convection)

Airborne moisture, vapour diffusion and solar-driven moisture are concerned with moving moisture in the form of a gas, water vapour.

Air can move through gaps and cracks in the building envelope, taking its water vapour with it. Such gaps and cracks may be caused by electrical fittings, wall/ceiling and wall/floor junctions, non-airtight butt joints in internal linings and so on. This moisture movement through the envelope usually dominates over vapour diffusion (which is concerned with passing moisture through the solid materials, not the gaps and cracks). Air moving from one room to another or into and out of the building taking water vapour with it is another form of airborne moisture movement.

g) Vapour diffusion

Of the three mechanisms for the movement of water vapour, diffusion is usually the least important.

Relative humidity

Water vapour (water in gaseous form) mixes with air, resulting in the air being 'humid'.

Humidity is measured in relative terms.

Relative humidity measures the actual water vapour in the air as a percentage of how much water vapour can be absorbed by air at a particular temperature and pressure.

As air temperature rises, the amount of water vapour that can be contained increases.

Air on either side of a roof or external wall will probably be at different temperatures and relative humidities, resulting in different 'water vapour pressures' between the inside and outside air.

Water vapour flows from regions of higher water vapour pressure to regions of lower water vapour pressure. In particular, where two bodies of air:

- have the same temperature but different relative humidities, water vapour will flow from the area of higher relative humidity, which has the higher vapour pressure, to the area of lower relative humidity, which has the lower vapour pressure
- are at different temperatures but have the same relative humidity, water vapour will flow from the area of higher temperature, which has the higher vapour pressure, to the area of lower temperature, which has the lower vapour pressure.

Assuming that interior air is warmer than outside air, water vapour is likely to diffuse from the inside warmer (higher vapour pressure) zone towards the outside cooler (lower vapour pressure) zone.

Drying by diffusion can transport moisture in either direction, depending on the type of wall system and the particular conditions. When the sun heats wall surfaces during warm weather, inward drying can be significant.

Managing vapour migration

Other than for extreme situations such as saunas, indoor swimming pools and buildings in very cold climates such as ski lodges, it is important that migration of water vapour is not interrupted by vapour barriers. Water vapour needs to be able to move through the wall to the outside to dissipate harmlessly, without damaging wall materials.

h) Condensation

The vapour pressure gradient drives diffusion, but when water vapour diffuses through a wall or roof it can move through changing temperatures (known as a 'temperature gradient') between inside and outside faces of the structure.

When inside air makes contact with cold surfaces (such as wall and roof claddings, or windows), the air temperature drops and liquid water may condense on the cold surface. This can occasionally happen within flat membrane-clad skillion roofs.

While the inside faces of the building envelope may not be cold enough for condensation, at some point on the temperature gradient within the wall or roof thickness (commonly at the back of the cladding) a temperature may be reached where liquid water is formed, as shown in Figure 10.

Vapour saturation

When air contains the maximum amount of water vapour it is capable of holding at its particular temperature and pressure, the relative humidity will be 100 percent, a condition known as 'vapour saturation'.

If the air temperature is lowered, the water vapour condenses out as liquid. If condensation occurs within a wall, this is called 'interstitial condensation'.

Figure 10: Interstitial Condensation

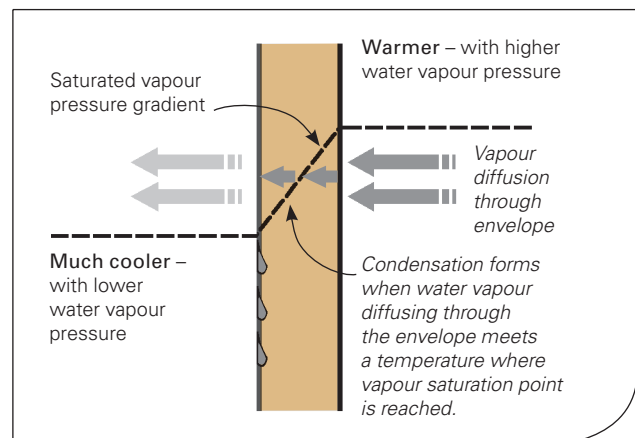

Over time, constant wetting from condensing water vapour can have a similar effect on the durability of materials and structure as water caused by a leak (although this is far more rare than damage caused by leaks).

Another situation that can lead to a build-up of water vapour and condensation is where air at high relative humidity within a drained wall cavity or from a sub-floor space migrates into roof or framing cavities. This type of migration can result in liquid water condensing on cold internal roof surfaces.

Managing condensation

Condensation can be controlled by:

- lowering relative humidity of internal air by ventilation and temperature control
- increasing thermal insulation
- eliminating sources of internal moisture
- ensuring drainage and subfloor cavities are sealed off from framing and roof cavities.

Managing solar-driven moisture

While solar-driven moisture is not a common problem in New Zealand, it can sometimes occur with absorbent claddings such as timber shingles.

For porous claddings, this can be minimised by painting the cladding (so reducing its absorptency).

i) Solar-driven moisture

This is a process where moisture can be driven into a wall when rain is followed shortly after by sunshine. There are two stages operating, as shown in Figure 11.

The first stage occurs when rain soaks into an absorbent cladding, via capillary transfer, as shown in Figure 11 (a). When sun follows shortly after the rain, a little moisture is driven through the absorbent cladding by vapour pressure and diffusion, as shown in (b). In other words, drying occurs in both directions, most to the outside, but some to the inside.

Figure 11: Solar-driven moisture

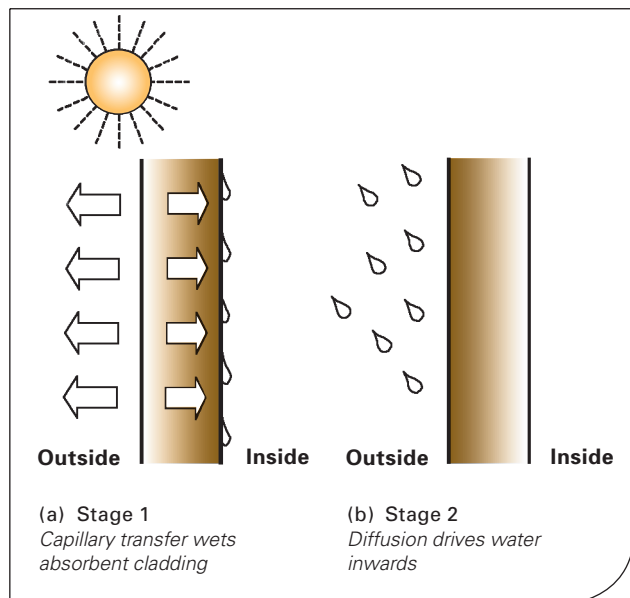

Because the temperature of the outside surface can be very high, the vapour pressure of the water is also very high. This results in much larger quantities of moisture being transported to inner surfaces than is normal.

3 Cladding principles

Our understanding of how traditional claddings protect against water penetration is based largely on experience and perception, rather than on research into why these claddings work. There have been extensive studies into more sophisticated types of cladding system for high-rise buildings, but only recently have studies (both here and overseas) begun to provide information on how common cladding systems and joints actually perform.

a) Traditional approach

The traditional model for the weathertightness design of wall claddings (apart from masonry veneer) used a simple approach based on two lines of defence (or layers) as shown in Figure 12.

Figure 12: Two lines of defence

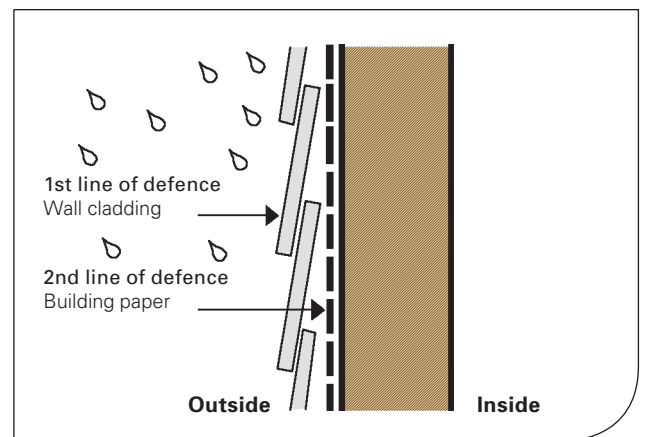

In this approach, the idea is to keep water out and to have a back-up layer in case it does get in. If 'keeping water out' is effective, then the back-up layer will rarely be used.

Claddings were traditionally designed to shed water effectively, with underlays and flashing systems providing drainage of occasional leaked moisture back outside.

Internal drainage

As a general rule, it is better to limit water penetration, rather than letting it in then directing it out again by internal drainage systems.

However, some proprietary cladding systems and products are specifically designed to be internally drained. Such cladding systems may be seen in commercial curtain walls, where drainage points are minimised as they can also become water entry points. Metal windows are also specifically designed to be internally drained, so it is important that the gaps for drainage are not blocked during installation.

This 'two lines of defence' approach can still work for some low-risk situations, and remains the 'first-step' thinking of the 4D approach (see opposite), especially when considering joint design.

However, achieving drainage without a properly formed drainage gap (relying on diffusion for drying) places higher durability demands on envelope materials and can lead to problems such as mould growth. Drying by diffusion alone is simply not fast enough to prevent moisture being retained within materials long enough to risk damage.

b) The 4Ds approach

This more comprehensive model of weathertightness goes beyond the simple two lines of defence concept by identifying the key qualities required for a wall to be weathertight.

The concept, borrowed from Canadian research, is known as the 4Ds of weathertightness design.

The 4Ds approach shown in Figure 13 identifies four basic components of an effective cladding system.

Weathertightness – the 4Ds

The weathertightness approach taken in E2/AS1 was developed from work done by two Canadians, Don Hazleden and Paul Morris, who developed a simple concept called 'the 4Ds' to describe the basic principles of water management in buildings. Their concepts were based on observations of leaks and subsequent water damage, and are considered to be just as applicable to problems experienced in New Zealand. The 4Ds, in order of importance, are:

- **Deflection:** shed water by a cladding system, including deflecting devices such as eaves and 'weathering' deflectors
- **Drainage:** a back-up system to direct water that may bypass the cladding back to the outside
- **Drying:** remove remaining moisture by ventilation or diffusion
- **Durability:** provide materials with appropriate durability.

Figure 13: The 4Ds approach to weathertightness

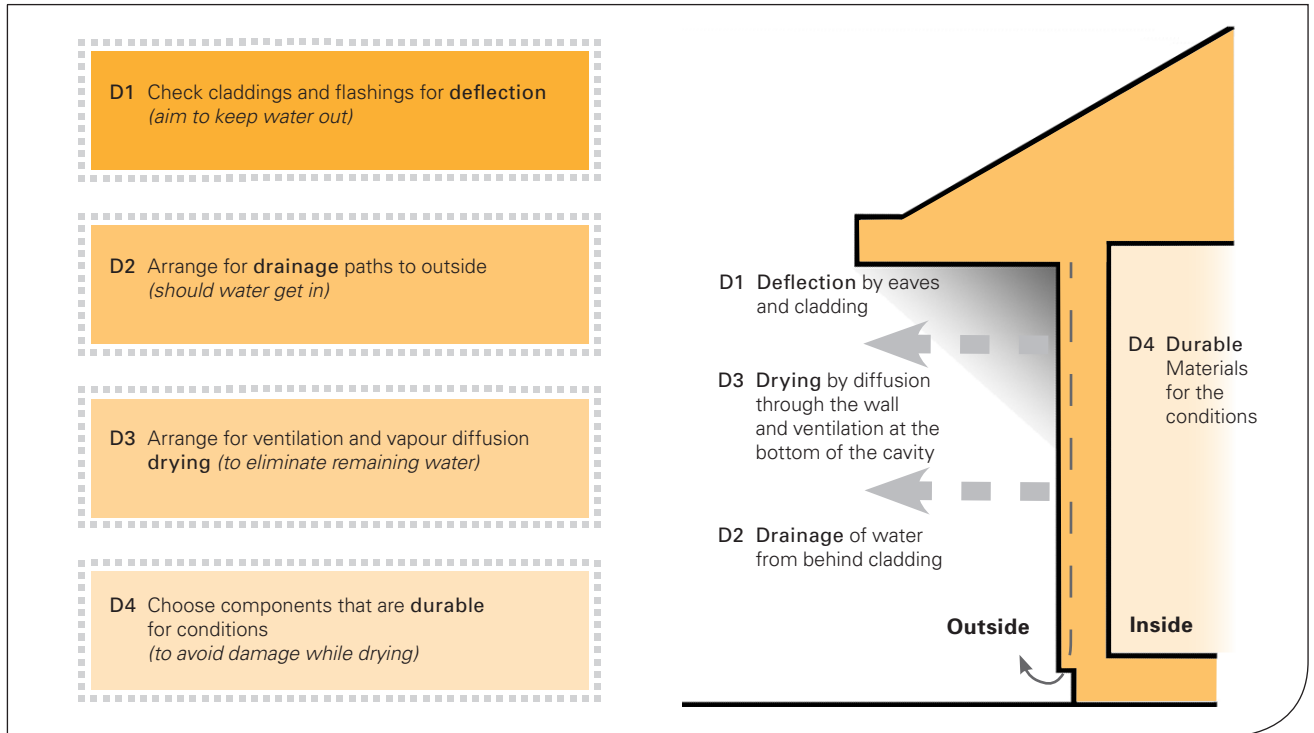

i) D1 – Deflection

Deflecting water away from cladding junctions can significantly reduce the water load on a junction (including junctions around openings and penetrations).

Deflection achieves this by using an effective cladding and reducing the amount of water that is able to reach a potentially vulnerable entry point.

Means of deflection

Deflection can be achieved in a number of ways, including by providing:

- a **cladding** system
- **overhangs** and shelters in the form of eaves, porches or verandahs
- **projections** or drip edges over horizontal junctions
- **overlaps** of both vertical and horizontal junctions.

Overhangs and shelters

Deep overhangs like porches and verandahs give the most protection by sheltering all or most of the wall beneath them, as shown in Figure 14(a).

Figure 14: Deflection

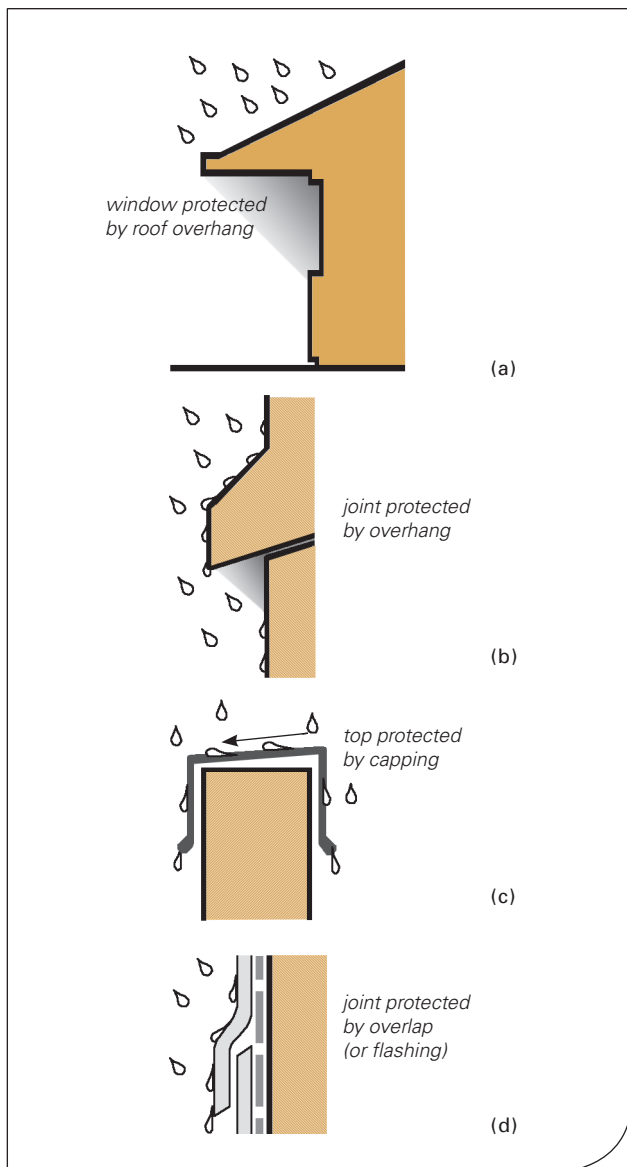

Eaves protect the upper part of a wall, the proportion varying according to the width of the projection and the angle of wind-blown rain. Effectiveness depends also on the height of the wall and the position of the eaves relative to the wall.

The higher a vulnerable junction is on a wall, the greater the protection from the eaves. The shape of a roof is also important, for example, hipped roofs protect walls on all sides, while gables provide limited protection at the verges.

Projections

Projections or drip edges provide shelter directly above a vulnerable junction, as shown in Figure 14(b) and (c). These may be considered as miniature versions of eaves or verandahs as they also deflect water away from joints or flashings, although on a much smaller scale.

Overlaps

Most reliable weathertight joints rely on overlaps provided by flashings or the cladding profile. Overlaps are used on both horizontal and vertical joints. The simplest is a horizontal overlap that sheds water to the outside, as shown in Figure 14(d).

Vertical joints (as shown in Figure 26) can also use overlaps, but these have little help from gravity and risk allowing water to track inside.

The effectiveness of side laps in vertical joints depends on the orientation, width of overlap, length of joint and the ability of the joint to drain.

Specialised pressure-equalised joints

Generally, the greater the overlap the greater the protection will be from water entry into joints.

However, the rate of airflow through a joint affects weathertightness, so some specialised pressure-equalised joints (such as those in metal windows) may be specifically designed to perform with smaller overlaps.

Although useful in limiting moisture, techniques using deflection are unlikely to keep all rain away from cladding surfaces and junctions, except in the cases of verandahs or deep recessed porches (see Figure 15).

Figure 15: Limits to deflection

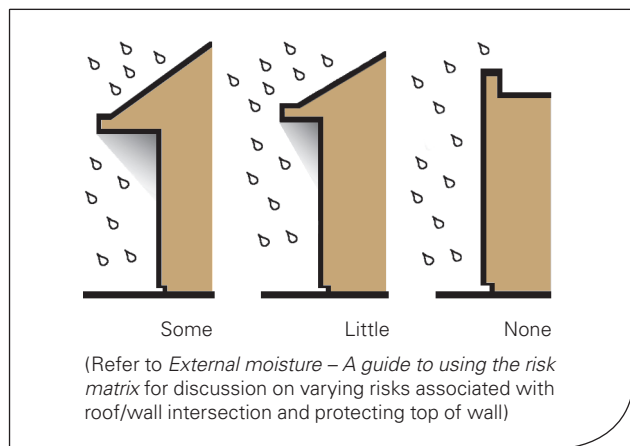

Even with deep overhangs, water can reach junctions from horizontal wind-blown rain during storms, or activities such as window or wall washing. It takes very little water on the face of a junction to start the process of water entry if the detailing is flawed and water movement is possible.

ii) D2 – Drainage

Drainage involves providing paths for any water that does get past the cladding to allow quick removal back to the outside before it can damage wall components. This is the quickest and most effective method of getting rid of water that has penetrated joints and junctions in a wall cladding.

Examples of drainage

- Cladding overlaps
- Flashings
- Wall wraps and roof underlays
- Providing cavities behind masonry veneer
- Drained cavities, as shown in E2/AS1

Flashings

Some water can be expected to enter a joint and this needs to be drained back out again.

Drainage has traditionally been the function of building wraps and back-flashings, and these must be installed to allow drainage to the outside, as shown in Figure 16(a).

Figure 16: Drainage

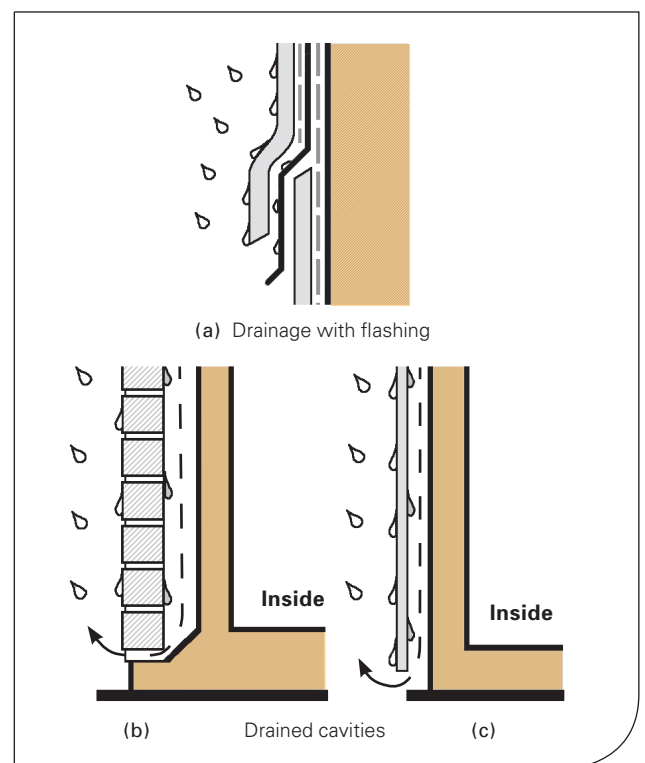

However, by themselves, building wraps and back-flashings offer limited protection in higher-risk situations, as too much reliance is placed on the weathertightness of the cladding system and the integrity of the wrap. Drainage down the building wrap cannot be controlled, and risks water penetrating into the framing.

Drained cavities

Drainage is significantly improved by packing out the wall cladding with battens to create a drained cavity behind claddings, as shown in Figure 16(b) and (c).

Water will drain in small cavities, but increasing the depth speeds drying by allowing ventilation as well. Speeding the drying process decreases the risk of fungal growth and decay.

iii) D3 – Drying

Drying removes water from the face of the cladding and any that does not drain out from behind the cladding. The latter is a slower process for getting rid of moisture, but it is still important. In our climate, periods of fine weather will eventually allow materials to dry out naturally.

Drying is primarily by ventilation but, where ventilation rates are very low, diffusion of water vapour also contributes. However, while drying by ventilation may take days, drying by diffusion alone may take months (particularly if a wall is shaded) as the process is slow.

If there is no drying (or if drying is too slow), building materials like timber eventually reach moisture contents that allow decay to start, even if they are treated to the minimum level of treatment now required for wall framing.

Figure 17: Drying

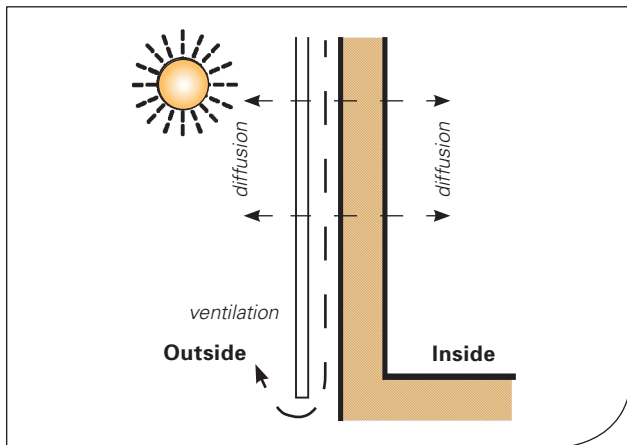

iv) D4 – Durability

The fourth D requires materials to have an appropriate durability for the anticipated environment. If envelope components (including claddings) begin to prematurely fail, walls and roofs can no longer be considered weathertight. So although it is not a leak prevention mechanism, durability determines threshold leakage levels that can be accommodated without causing damage.

Providing and maintaining durability (using durable materials) allows materials to continue functioning, even if they may become occasionally wet. It provides time for drying to occur before damage or, in the case of a junction failure, for the fault to be discovered and repaired.

Different materials have different vulnerability to moisture damage. It is the designer's and builder's responsibility to ensure materials are not specified or used where they are not suitable, such as where they are exposed to conditions that exceed their acceptable conditions, or where materials in combination are detrimental to each other.

Despite best intentions, water may still enter the body of the wall. Material durability is critical as a safeguard in ensuring the long-term survival of the wall system. It is the owner's responsibility to ensure the provided durability endures, so maintenance of claddings is critical.

Decay resistance

The fourth D proposed by the Canadian research stood for 'Decay resistance' but Durability has been adopted as more suitable. It covers all building materials, including their fixings.

Part B: Weathertightness principles applied

Part A considered forces and physical mechanisms that can cause leaking, and the principles that apply to weathertightness. Part B now explains how components of a building envelope can manage these forces in ways that provide effective weather-resisting systems.

1 Wall-cladding systems

Walls vary in their nature and may be divided into two broad categories – mass construction and framed walls. Framed walls can then be further divided according to different cladding systems used with them. Cladding systems may be grouped as shown in Figure 18.

a) Mass wall systems

Mass walls – Figure 18(a)

Mass walls rely on thickness to provide sufficient absorption in the outer layers without affecting inner surfaces. They also require sufficient durability to accommodate continual wetting and drying without deterioration of the material.

Mass walls do not respond well to external weather sealing or coatings restricting vapour transference. Interruption of ‘breathability’ of the wall material can lead to moisture build-up within the walls.

Figure 18: Types of wall

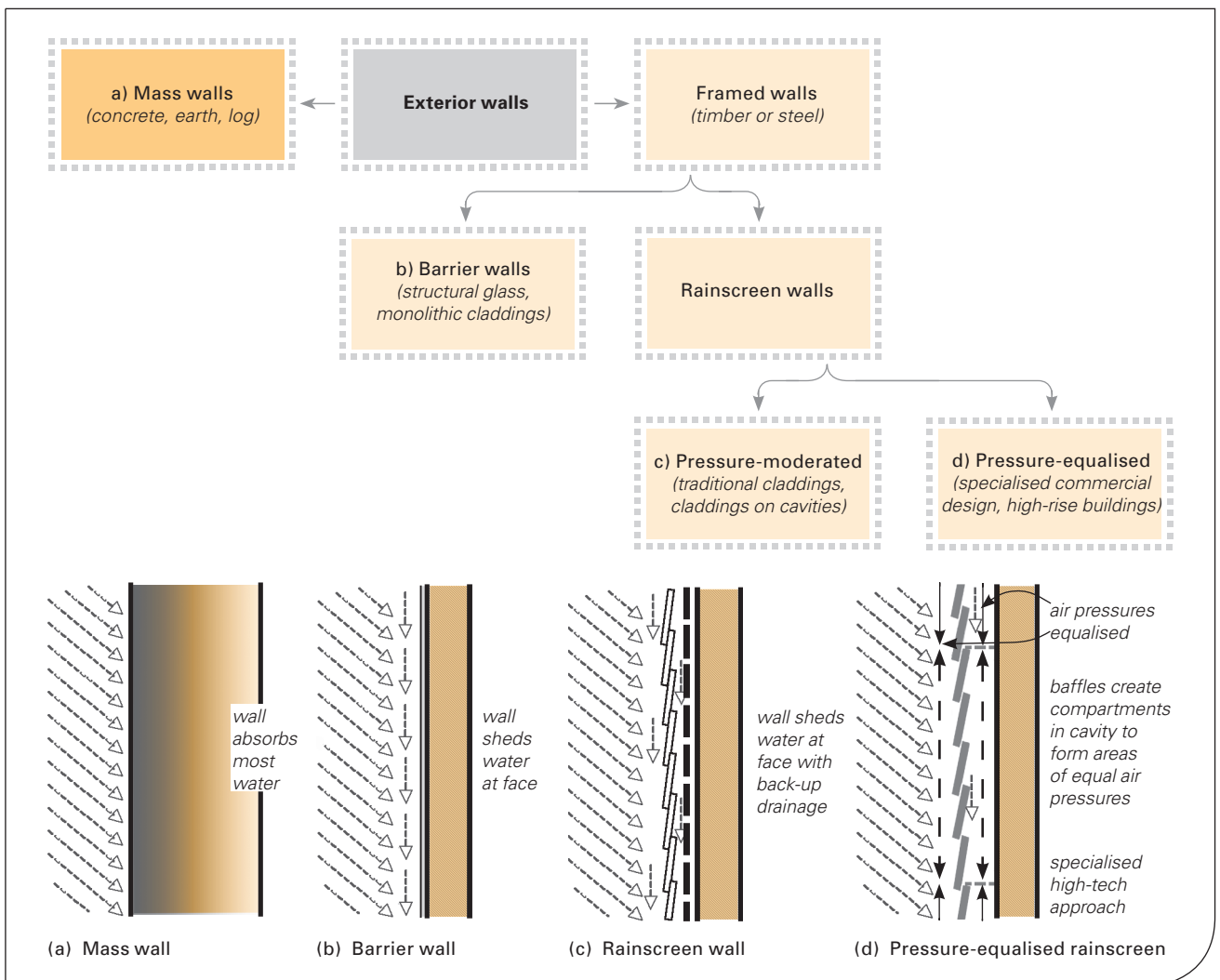

Mass walls, such as load-bearing concrete, masonry, logs, earth and so on, are the oldest strategy for protection against moisture. They depend on a wall having enough capacity to absorb all rainwater that is not drained from the surface, and being able to hold that water until it eventually evaporates.

Mass wall systems can either act as primary structural systems in themselves, or as secondary infills to primary structural frames.

b) Barrier systems

At the other extreme from mass walls, barrier or face-sealed systems aim to stop all water penetration at the outside surface with joints designed to stop water entry.

Cement and sand stucco is an example of a traditional type of barrier system that now has a version (included in E2/AS1) incorporating a cavity. Most other monolithic cladding systems are more recent, as they rely on modern synthetic jointing, plaster, paint and sealant systems.

Monolithic cladding systems – Figure 18(b)

Sealant joints are not reliable long-term barriers unless they are properly designed and maintained, so E2/AS1 requires a cavity for situations that are moderate or higher risk.

It is very difficult to build and maintain a perfect barrier wall. Most face-sealed claddings therefore tend to act in the same way as either a mass wall or a cavity wall.

However, they lack the same capacity to dry or drain, so may be prone to rapid deterioration when water penetrates the barrier.

c) Rainscreen systems

Rainscreen systems lie between the two extremes described above. This type of wall assumes that some rainwater may penetrate the outer surface (hence the cladding 'screens' rain). The design of the cladding allows unintended leaks to be managed by draining (with drying) the water away before it penetrates further into the wall structure.

Rainscreen walls may be subdivided into two types – traditional cladding systems that rely on a 'two lines of defence' approach as shown in Figure 12, and claddings that incorporate a cavity as part of the weather-resisting system.

Rainscreen systems – Figure 18(c) (d)

These include:

- traditional rainscreen systems
- rainscreen-cavity systems.

i) Traditional rainscreen systems

Rainscreen systems are now understood to include traditional cladding systems (as shown in Figure 12) such as direct-fixed weatherboards (including board and batten) and similar types of cladding. We have termed these 'traditional rainscreens', and they fall within the type of wall shown in Figure 18(c).

Weatherboards remain one of the most common types of wall cladding for New Zealand houses, and have been proved over time to provide adequate drainage in most low- to medium-risk situations, as small gaps at the laps allow sufficient drainage and drying.

ii) Rainscreen-cavity systems

When the risk of leaking is higher or when cladding junctions cannot easily incorporate traditional flashings, then additional drainage in the form of a cavity is necessary.

While these types of cavity are not designed to act as drains, they are designed to manage moisture by drainage and drying. As the width of the cavity increases, the third D (Drying) increases in importance as an additional defence.

As shown in Figure 19, there are two basic options for allowing drying within a cavity: (a) provides vents at the top and bottom of the cavity (as in masonry veneer), while (b) leaves only the bottom open (termed a 'drained cavity' in E2/AS1). A drained cavity still allows ventilation of the cavity, but at a reduced level from that provided by cavities with top and bottom vents.

Figure 19: Types of cavity

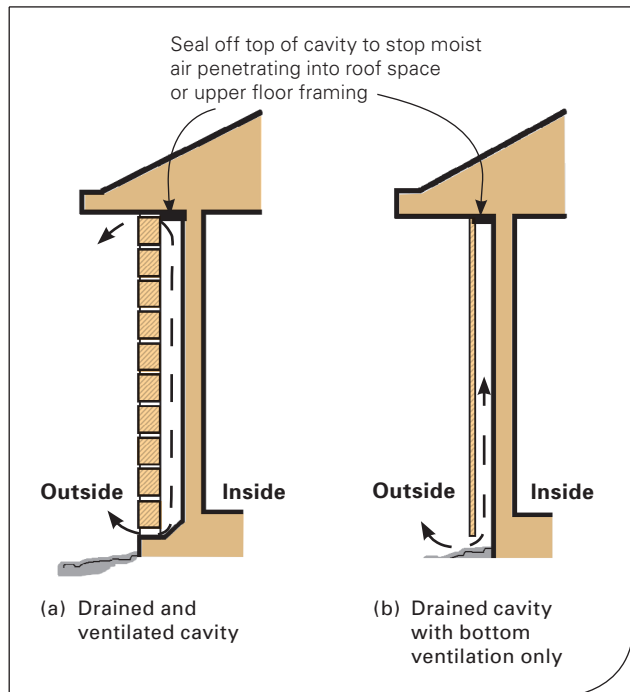

Pressure moderation

Both Figure 19(a) and (b) have pressure-moderated cavities, which limit the amount of water forced into the cavity by wind pressures.

As shown in Figure 20, while the wall underlay provides some pressure drop, most of the pressure drop is supported by internal linings and air seals around openings, which perform as air barriers.

Figure 20: Pressure moderation

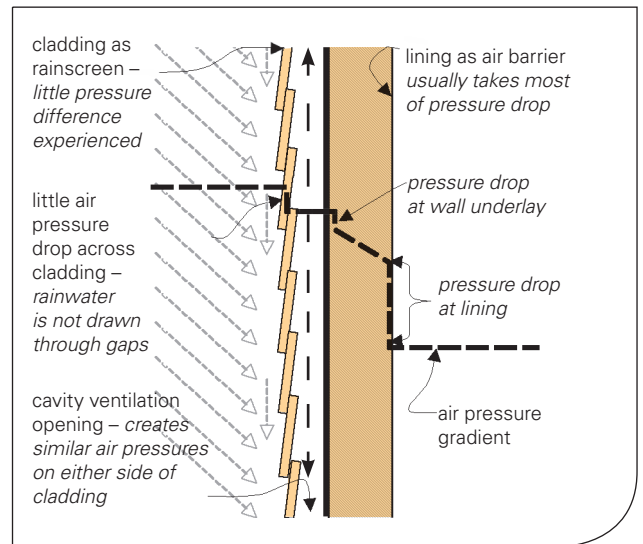

More sophisticated examples of drained and ventilated, and pressure-moderated or equalised, systems may be found in modern commercial curtain-wall applications.

Open rainscreens

There are other types of more open rainscreen that are sometimes used in front of a wall, but these are not covered in this document.

E2/AS1 drained cavity

A drained cavity can be provided by packing the wall cladding out on battens and creating a drained cavity behind, as shown in Figure 21.

Figure 21: E2/AS1 drained cavity

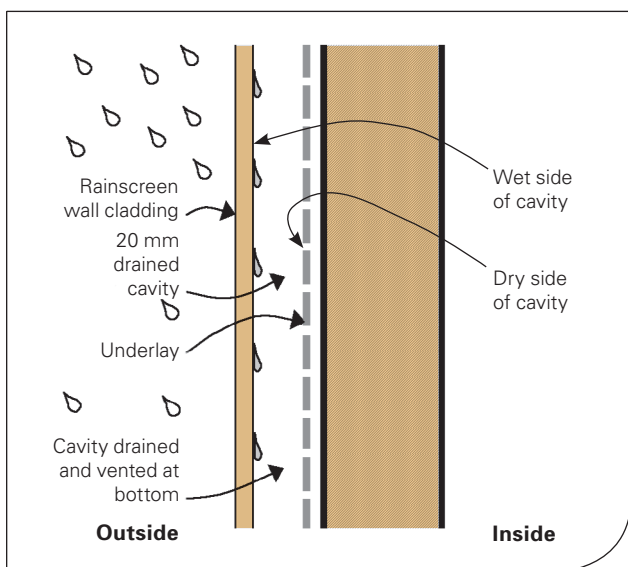

This improves the drainage capacity and allows ventilation and drying to take place between the cladding and the rest of the wall. As shown, the aim is to restrict moisture to the 'wet' side of the cavity, away from the wall underlay and framing.

E2/AS1 drained cavities

The concept of the wet and dry sides of the cavity means that, in most cases, the cavity should not be bridged, and flashing upstands etc should be positioned where possible on the wet side.

However, as some details in E2/AS1 show, there are instances where a flashing must bridge the cavity, for example at window heads and at inter-storey junctions for walls over two storeys high. In these situations, moisture will be draining from above the flashing, so must be diverted to the outside.

Masonry veneer cavities

The air space of a cavity is more important for more absorbent claddings (and higher rain intensity). This is because water passing through the cladding requires greater amounts of drainage and drying.

It is recognised that masonry absorbs water and some moisture may run down the back of the veneer. Masonry veneer cavities must be deep enough to cope with possible moisture, and need well-formed drainage channels at the bottom to drain any moisture to the outside. Drying by ventilation is particularly important in this construction, so top as well as bottom vents are needed.

Masonry veneer cavities might be expected to remain damp for prolonged periods, but this seldom occurs. The limitations of veneer construction generally tend to lead to simpler building types where water entry is minimised with deflection by eaves, lower wall heights, fewer complex junctions and so on. Also, the nature of brick is such that the material is able to store some moisture until it eventually evaporates. The drying process is also helped by the heat that can be stored in the masonry and generated into the cavity. Where walls are particularly exposed to the weather, greater demands are placed on the durability of wall components, so additional care is needed.

d) Pressure-equalised rainscreens

The aim of pressure-equalised rainscreens is to balance air pressure across the cladding, minimising air movement and consequential water entry.

Success depends on factors such as avoiding pressure differentials (caused by pressure gradients around the building) across a cavity by creating compartments with baffles, avoiding air leaks within the cavity and careful designing of openings in the rainscreen.

A simplified pressure-equalised rainscreen is shown in Figure 18(d). The principles behind pressure equalisation can be summarised in three stages – rainscreen, pressure-equalised cavity and air seal. These principles are applied to junctions used in more general construction, as shown in Figure 23.

Pressure equalisation with rainscreens

Pressure equalisation with rainscreens is a very specialised and therefore expensive design procedure. It is best suited to larger buildings where particularly high wind pressures require a sophisticated approach to weather resistance in cladding design.

Pressure-equalised rainscreens are therefore outside the scope of this document. However, they are mentioned, as many principles behind pressure equalisation can be adapted for use in general cladding and jointing systems (see 'Pressure differentials' on page 12).

2 Wall-cladding joints

Part A discussed the influences that can make a joint vulnerable to water penetration.

The design of cladding joints needs to incorporate defences against these forces and mechanisms.

Figures 22 and 23 demonstrate where the 4D principles should be applied to joint design.

Figures 22 and 23 also show where air seals should be positioned to provide resistance to pressure differences between inside and outside air.

Figure 22: Horizontal joint

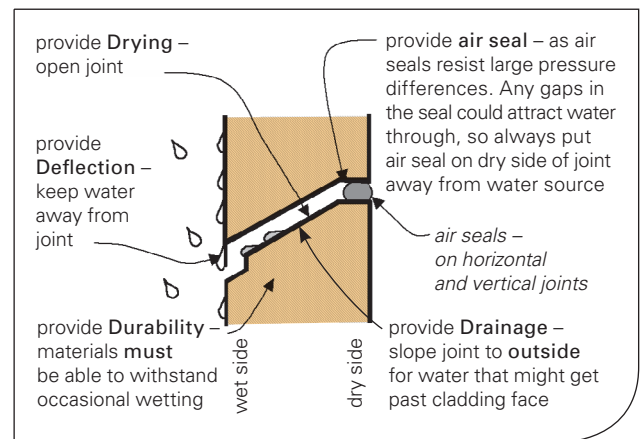
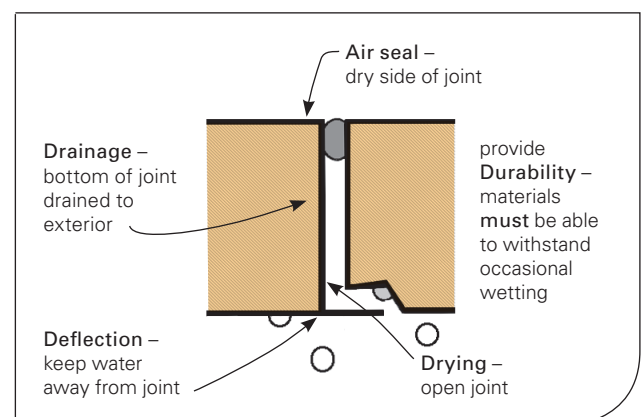

Figure 23: Vertical joint



As well as the 4Ds, the joints shown in Figures 22 and 23 can also be considered in regard to the three basic principles of pressure equalisation described in 'Pressure-equalised rainscreens' on page 26.

These are:

- rainscreen
- cavity
- air seal.

a) Horizontal joints

The design of horizontal joints should aim to provide deflection (D1) along with drainage (D2) to divert and drain water away from a potential entry point. This may be achieved by using adequate overlaps, as shown in Figure 24, whether via the cladding itself as in (a), or with the use of flashings (sized to suit factors such as wind exposure) as in (b).

Figure 24: Horizontal joints

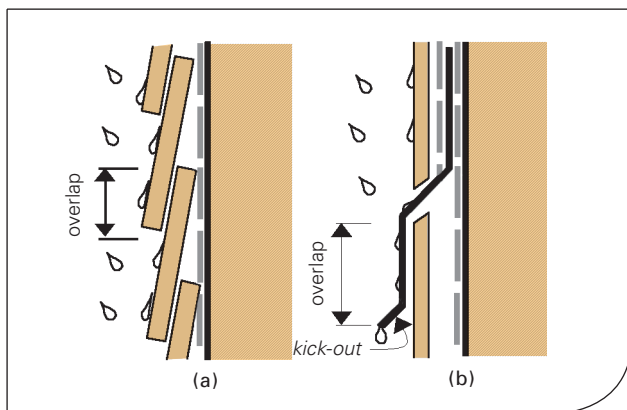

As discussed in Part A 2 e) on page 14, protection against water penetration from capillary action can be provided by detailing separation at critical points in capillary paths in the form of:

- gaps
- rebates
- drip edges
- kick-outs
- 'bird's beaks'.

Separation details, such as those shown in Figure 25, are critical for both horizontal and vertical joints. Separation may be provided by grooves, as shown in (a), or by gaps, as shown in (b).

Edge treatments such as kick-outs, as shown in Figure 24(b), or bird's beaks are critical for preventing water capillary rise in components such as flashings.

In weatherboards, protection against water capillary rise is provided by rebates in the back of the boards.

Figure 25: Anti-capillary separation

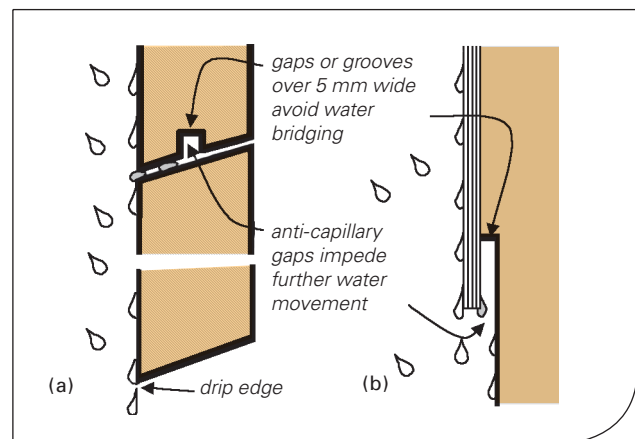

b) Vertical joints

Deflection alone cannot be relied upon to provide weathertight vertical joints, as water will run down the joint and may move sideways to find its way past the defence of the overlap. If water does penetrate, a system is needed for draining it out again. Vertical joints should therefore aim to incorporate drainage (D2).

Figure 26: Vertical joints

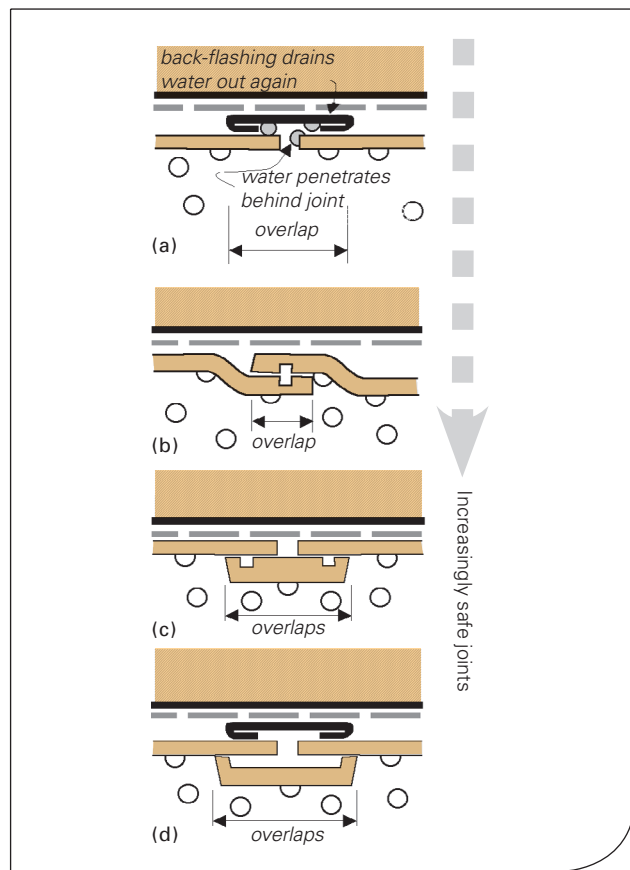

i) Lower-risk situations

Vertical joints in low-risk situations use defences, such as capillary breaks, flashings and a water barrier (building underlay), to resist further inward movement of any water that penetrates the overlap or seal.

The joints shown in Figure 26(a) and (b) use the 'first and second line of defence' concept. This system of providing drainage has been traditionally used in timber-frame construction. It provides adequate drainage for some types of cladding and jointing in most low-risk situations.

ii) Positive vertical joints

Positive joints, as shown in Figure 26(b), (c) and (d), are very common and safe joints that have been long used in timber-frame construction.

They include any type of joint where a cover, such as a batten, is used to protect the underlying joint. They may be used in a variety of situations, including for higher-risk joints.

Using overlaps

In most cladding junctions, overlaps (sized to suit the risk level) together with drainage must be provided to guard against water penetrating into the vulnerable underlying joint. However, in specifically designed approaches (such as in window installation), air flow management by air seals (pressure equalisation) allows a more specialised approach to be taken to overlapping window flanges over the cladding.

iii) Negative vertical joints

Negative joints are designed to control water within a cladding joint and then to direct it out again with back-flashings. Success is therefore dependent on the capacity of the joint to deflect and drain the 'captured' water.

The simple type of negative joint shown in Figure 26(a) should be restricted to lower-risk applications where the incidence of rain on the cladding is limited. However, more sophisticated pressure-equalised negative joints have wider applications.

Drained vertical joints

A specialised type of negative joint is known as a ‘drained joint’. While sealed joints rely on the performance of the sealant to keep water out, drained joints are designed to allow some water in and then to drain it away before it penetrates further into the wall.

Drained joints use the three principles of pressure equalisation to prevent water from penetrating through the joint.

The joint design ensures air and water pathways are separated (see Figure 23) with regular horizontal drainage points provided to redirect water back to the outside. Wind pressures are also supported by the air seal on the dry side of the joint.

The drained joint (with baffle) in Figure 27 is a special type of negative joint that is more common in commercial buildings than in residential ones. These joints need wall depth, and are commonly used with commercial wall claddings such as precast concrete panel systems.

Drained joints
 In precast panels positive covering of the joint may not be practical. The actual rainscreen is the baffle, positioned within the depth of the panel.
 The panel should therefore sit in a water-resistant rebate or flashed joint to ensure water is redirected back to the outside.

Figure 27: Drained joint

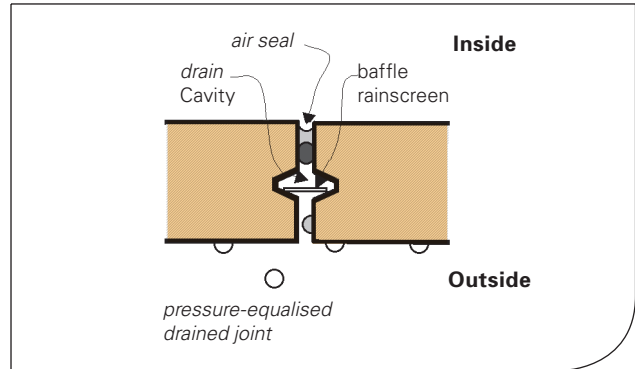

c) Sealed joints

Joints that rely on sealant alone for weather resistance are dependent on specialised joint design and sealant application. Critical factors for success include:

- joint dimensions with a ratio of 2:1 width:depth
- careful selection of durable sealants (with bond breakers) suitable for substrates
- careful preparation of substrates
- specific application procedures
- regular maintenance to remedy any defects.

As such, these joints tend to be part of proprietary cladding systems, and are outside the scope of this guide.

Figure 28: Sealant joints

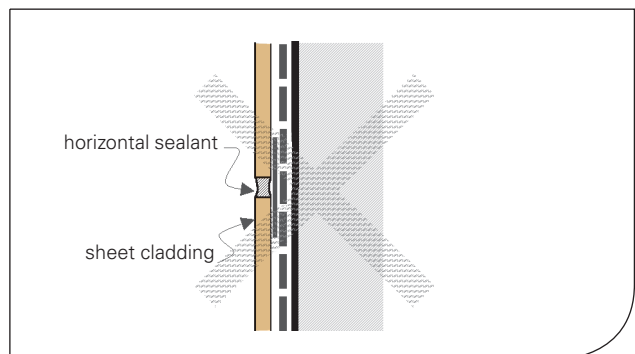

It is risky to use sealed joints for horizontal or diagonal joints in walls.

Where sealant joints are used in general cladding systems, they need back-up flashing and drainage systems due to the high risk and potential consequences of sealant failure.

Sealant joints should only be used for vertical joints. This is unless a water management system is specifically designed or sealant joints are used where sealant failure is less damaging, such as in sealed glass systems.

d) Cladding absorbency and texture

i) Absorbent claddings

A cladding material's absorbency affects the weather-resisting properties of the cladding system as a whole. Absorbent claddings, such as uncoated masonry or timber, slow the rate at which water travels across or down a cladding. This may reduce the moisture 'load' on joints, but the advantage is short term and is lost after prolonged wetting and saturation of the surface. Also, any advantage for joints is outweighed by potential moisture transfer ('wicking') through the absorbent material. Examples of this moisture transfer can be seen with unsealed fibre-cement sheet and unpainted single-skin concrete block walls.

Masonry walls

Water may pass through to the inside via the masonry and the joints, whether the masonry is solid-filled or not. Clay brick or concrete block veneers therefore need cavities.

Single-skin 200 mm concrete block should be appropriately sealed and coated. Once paint on concrete block deteriorates, the water-proofing is lost, so paint coatings must be maintained.

ii) Non-absorbent claddings

Non-absorbent cladding materials (such as metal, glass or coated sheet materials) allow all or most rain to flow freely down the cladding face, with the risk of overloading lower cladding joints.

Water can also travel in sheet form across the cladding face, resulting in joints that are susceptible to pressure differentials being at greater risk of water penetration, as shown in Figure 29(b).

Figure 29: Cladding surfaces and vertical joints

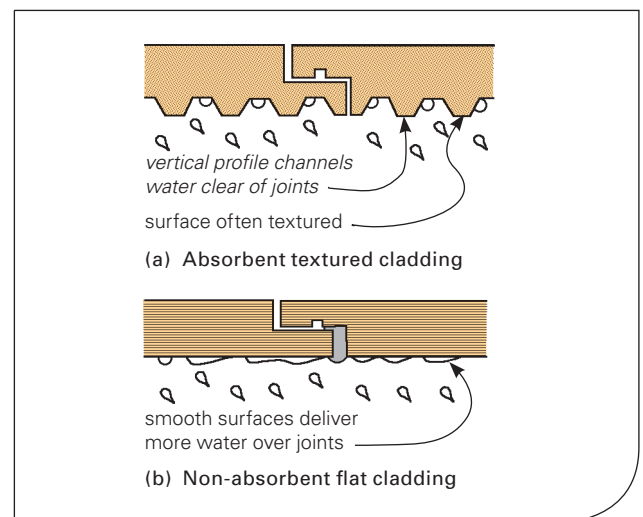

iii) Textured surfaces

Claddings may also have textured surfaces that physically slow the passage of water across their surfaces.

Some claddings, such as face-fluted concrete as shown in Figure 29(a), may be so highly textured that water travel across the surface is negligible. Because such claddings strongly channel water in particular directions, weatherproofing is improved if this channelling is in a vertical direction.

In contrast, horizontally textured cladding tends to direct water sideways towards vertical joints, which must therefore be designed for the extra water load that this will cause.

3 Roof claddings

Many principles of wall design apply equally to roofs. When designing weathertight roofs, the basic principles are to use overlaps to shed water to the outside, and slopes to avoid ponding by directing water towards drainage points. Completely 'flat' roofs and 'flat' gutters are not part of good roofing practice. Those that appear flat still require minimum falls to allow drainage.

Roofs must handle more rain than most walls, so overlap and upstand dimensions for adjoining materials usually need to be more generous than for wall claddings. Directing devices (such as hip, valley and apron flashings, kick-outs and internal gutters) serve important functions by deflecting water towards outlet drains as quickly as possible.

Initial roof design

The initial design of a roof should be carefully considered in order to minimise risks of water entry. Roofs with complex junctions have higher risks.

It is easier to minimise complex junctions at an early stage in the design process, rather than handling the complexities involved in detailing and building successful complex roofs. Positioning penetrations through the roof is also important in limiting risk, as shown in Figure 30(a).

Figure 30: Positioning of roof penetrations

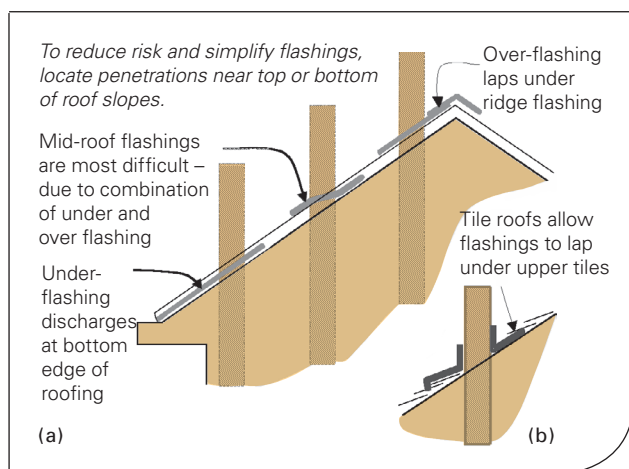

For long-run metal or membrane roofs, placing penetrations near the top or bottom of roof slopes allows flashing systems to be 'under' or 'over' flashed. Those in the middle of roofs need more complex and risky combination systems (possibly with special diversion flashings). Flashing of penetrations is easier for tile, shingle and shake roofs due to the many horizontal joints under which the upper edges of flashings can be lapped, as in Figure 30(b).

a) The 4Ds in roof design

Designing for roofs is similar to designing for walls, and using the 4Ds can improve the effectiveness of roof design.

i) D1 – Deflection

Just as for walls, deflection is the first consideration. While eaves deflect water away from walls rather than the roof, the roof pitch deflects water away from vulnerable roof joints and junctions.

Generally, the steeper the roof pitch, the better the deflection because more water is shed more quickly, as shown in Figure 31, reducing the risk of leaking.

Figure 31: Roof deflection

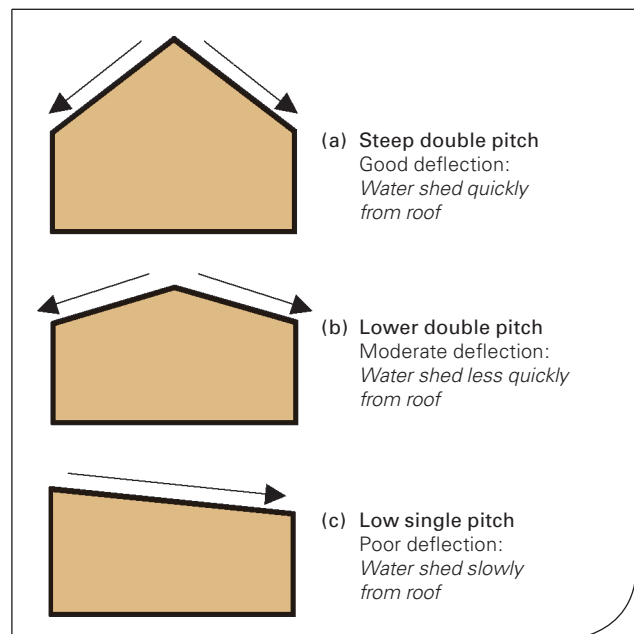

Minimum and maximum slopes

It is worth noting that there are appropriate maximum and minimum slopes for different roof claddings, and manufacturers' recommendations should be consulted.

For instance, tile roofs with many joints work best at higher slopes. Barrier-type membrane roofs can have problems caused by air pressures fluctuating around more steeply pitched roofs.

Roofs falling in two directions, as in Figure 31(a) and b) (eg, simple gable and hipped shapes), shed water more quickly than a monopitch roof covering the same area, as in Figure 31(c).

To shed water quickly, it is also important to have the most direct drainage paths possible. Complex roof forms, with associated complex drainage systems, increase risks of water entry. Generally, roofs should be designed as simply as possible to deflect water to perimeter drainage points as directly as possible with water collected in gutters to minimise run-off over wall cladding.

Simple steps to help deflection

The following are some commonsense measures that improve deflection and help reduce the risk of leaking.

- 1) **Overlap roof claddings and underlays:** To deflect water to the outside, away from prevailing weather, where possible. Like walls, individual flashings and cladding sections or sheets must be arranged as a complete system to direct water to the exterior.
- 2) **Internal box gutters:** Avoid internal box gutters where possible. Perimeter gutters are preferable and should be designed to allow overflow to spill to the outside of the building. Box gutters act like negative wall joints (see page 28, 2 b) iii)) and have a limited carrying capacity. Where unavoidable, ensure box gutters have:

- a) at least two or three times calculated rainfall capacity, with significant side depth
- b) at least two outlets for each gutter (in case one blocks)
- c) significant falls and rainwater heads to promote water flow at drainage points
- d) overflows to the exterior to cope with a 'worst case' event
- e) adequate width and strength for regular checking and maintenance without damaging roof edges (box gutters are often used as pedestrian access for roof maintenance).

- 3) **Decks:** Treat all enclosed decks as if they are roofs. So-called 'flat roofs' must have sufficient fall to avoid water ponding. Ponding slows or prevents drying and can soften membranes and joints, in time leading to leaks. When designing and building enclosed balconies and decks, follow similar principles to those described for box gutters.
- 4) **Deck and roof-to-wall junctions:** Provide adequate clearances. Leaking often occurs where there is little or no step-down with waterproofing reliant on sealant joints. Step-downs between the inside and outside allow adequate overlap of wall claddings over roofing/deck turn-ups and flashings. No cladding should finish hard down onto the deck or roof surface, as this inhibits cladding drainage, prevents maintenance of the cladding bottom edge, allows wicking of moisture up into the cladding, and can lead to decay in timber bottom plates.
- 5) **Water flow and collection:** Avoid concentrations of water flow to vulnerable points in the roof. Capacity of flow channels must increase as they approach collection and outflow points. Avoid locating water collection points at vulnerable joints and junctions of under-and-over flashings (eg, a valley gutter discharging onto lower roof areas).

ii) D2 – Drainage

Primary drainage is provided by the outer roof cladding, with secondary drainage usually provided by the underlay. A wall wrap is not suitable to use as a roof underlay, as water absorption is more important for roof underlays.

Because roofs are set at an angle, water run-off from underlays is not as direct as for walls (with some roof pitches almost flat). The underlay must be able to cope with moisture for longer periods than a wall wrap needs to. (The underlay also needs to protect against the risk of electrolytic corrosion between metal roof or wall claddings and treated timber framing.)

The outer surfaces of metal roof (and wall) claddings also tend to be colder than other types of cladding, creating a risk of condensation dripping onto the underlay. To compensate for this, the current requirements are for increased absorbency to contain water until it can dry out again (most roofs have good drying qualities).

Roof underlay

The roof underlay performs similar functions to those of wall wraps, including:

- secondary drainage
- creating a still air space in the roof cavity
- carrying air pressure differences (if used as an air barrier)
- acting as a moisture reservoir to regulate dampness during normal wetting/drying weather cycles.

Water absorption is also important for the wall underlay behind a profiled metal wall cladding, so the underlay for this type of cladding needs to have the same qualities as roof underlay.

For masonry tile roofs over certain pitches, underlays are not required (see E2/AS1 for minimum pitches).

iii) D3 – Drying

As mentioned above, 'drying' is an important feature for roofs. Tile, shingle and shake roofs generally have good 'breathability' via laps and drying is easily achieved. Roofs also have areas of both negative and positive pressures that can promote air movement for drying. These pressure differences can be evened out by using vents (such as vented ridge caps).

Like monolithic wall claddings, membrane roofs have no natural ability to breathe through joints, so drying is interrupted. For this reason, skillion membrane roofs in particular need added ventilation to compensate for the lack of natural venting through the membrane.

Condensation

Condensation on the underside of roofing is brought about by a combination of factors, which can lead to significant amounts of moisture being drained and absorbed by the underlay.

These factors include:

- high daily temperature differences
- a lack of added thermal insulation and low insulating roofing such as thin metal
- moisture-absorbent roofing such as timber shingles and unsealed clay/concrete tiles
- vapour-resistant materials such as membrane roofing
- water vapour accumulation from other parts of the building.

As the roof pitch decreases, the condensation moisture that will find its way down the underside of the cladding to the outside will also decrease. It is therefore important to have an underlay, together with ventilation for low-pitched roofs.

iv) D4 – Durability

Under the Building Code, roof claddings and underlays are required to last a minimum of 15 years. However, many roofing materials are expected and likely to last much longer than that.

Where significant amounts of moisture are expected on the roof underlay, minimum durability requirements for supporting timber framing should be increased for added protection (NZS 3602: 2003 Table 1D.1 requires higher levels of timber treatment for sarking and framing that are not protected from solar-driven moisture resulting from absorbent roofing materials.)

As in wall claddings, ongoing maintenance is important to ensure durability. The design and detailing of roof claddings should allow for easy inspection and maintenance by future building owners.

4 Floors

a) Floor levels

The height of the floor level above the finished ground level plays an important role in preventing external water entry.

E2/AS1 gives minimum clearances required from the bottom of wall cladding and the interior floor level to adjoining ground or paving.

Select floor/ground clearances to:

- maintain adequate 'freeboard' above surrounding land levels that are subject to flooding
- allow adequate cladding overlaps to foundations
- keep timber framing and wall cladding materials clear of damp ground
- minimise wetting of claddings from water splash
- promote drying of building materials by keeping them free of obstructions to air movement, such as close embankments and overhanging foliage.

Critical clearances shown in Figure 32 are:

- **interior floor level** to protect the wall framing from ground dampness and to allow for adequate overlap of cladding over the foundation
- **bottom of the cladding** to protect the bottom of cladding from dampness and to allow maintenance of bottom edges.

Figure 32: Adequate clearances

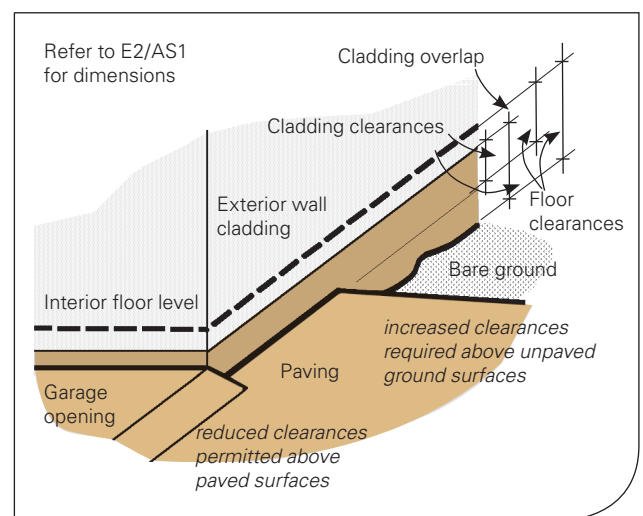

Clearances reduced below E2/AS1 requirements

Reduced clearances may sometimes be adequate (eg, above well-drained paving sheltered beneath roof overhangs, or when specialised anti-capillary devices are used).

However, such cases will need to be designed and assessed as alternative solutions.

There may be times when the topography of a particular site means that E2/AS1 minimum clearances should be increased.

Specific site conditions, such as that shown in Figure 33, need to be considered and provided for at an early design stage.

Figure 33: Floor levels related to site

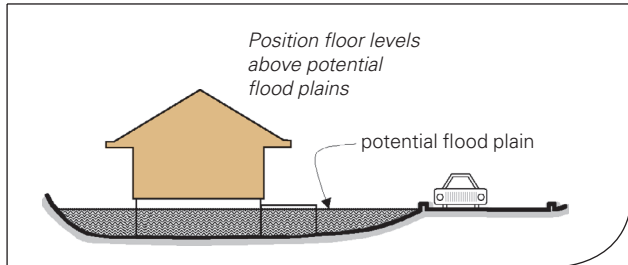

b) Timber-framed floors

Timber-framed floors need adequate ventilation and clearances above subfloor ground levels to ensure durability of the subfloor timbers.

Ventilation requirements depend on the area and shape of the ground floor plan. Normal acceptable amounts of ventilation are described in NZS 3604.

Timber-framed floors

Clearances below timber-framed floors are needed to:

- allow subfloor ground to be at a higher level than surrounding ground to avoid water ponding under the floor
- allow adequate subfloor air flow to promote drying
- ventilate water vapour released from subfloor ground
- allow access for inspection and repairs of foundations, framing, service pipes and other subfloor components.

Note: reduce the rate of vapour release from damp ground with membrane covering (eg, polythene sheet) over the subfloor ground.

Warning on heat losses

While it is very important to provide adequate ventilation to subfloor spaces, it is also important to be aware that over-ventilation can affect the thermal insulation properties, and could result in unnecessary heat losses through the floor. However, these can be overcome by increasing floor insulation.

Warning on movement

Remember that most walls supporting flush-finished monolithic cladding depend on stable support. Relative settlement of pile foundations or flexing of cantilevered floor joists can be transferred into cladding joints and can cause joint cracking.

Figure 34: Timber-framed floors

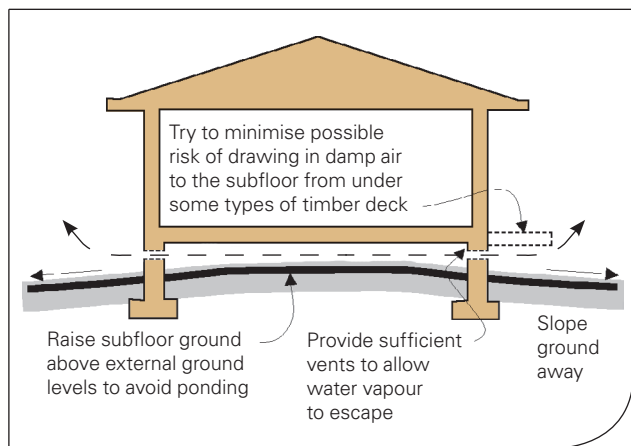

c) Slab-on-ground

Concrete slabs also have particular weathertightness problems to consider, as shown in Figure 35, in addition to the relevant clearance requirements discussed above.

Figure 35: Concrete slab-on-ground

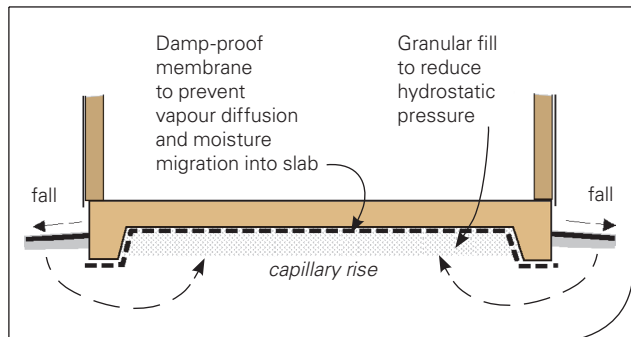

Concrete slabs

A concrete slab-on-ground must be formed over a:

- layer of granulated fill to reduce capillary rise of moisture towards the underside of the slab
- damp-proof membrane (DPM) to prevent penetration of water vapour (released from ground) into the concrete slab.

5 Retaining walls

Retaining walls that form walls of internal spaces need special consideration. Design and construction must be carefully considered and thoroughly executed. Remedying defects later may be extremely difficult and expensive. Sometimes they will be impossible to achieve without considerable structural demolition of the building or surrounding ground. Reliable and effective waterproofing is usually only possible on the wet side of a retaining wall. Most sealing products applied to the dry side of a wall risk being 'blown' off the face of the concrete from water and vapour pressure migrating through the concrete.

The following are general descriptions of four common configurations for concrete retaining walls suitable for use in association with timber-framed buildings.

a) Retaining wall/slab

Two basic options are available for a retaining wall/slab combination, as shown in Figure 36.

Option 1: DPM below slab – Figure 36(a)

In this most common option, water deflection (D1) relies on:

- adequate overlap of the wall cladding over the top of the retaining-wall damp-proof membrane (DPM)
- good overlap and junction between the wall DPM and the upturn of the floor DPM at the base of the retaining wall (note: this junction is not always easy to form).

Option 2: DPM on tidy slab – Figure 36(b)

This option uses a tidy slab under the slab footing, which allows a more reliable seal to be formed between the wall and floor DPMs. As for option 1, water deflection (D1) relies on adequate overlap of the wall cladding over the top of the retaining-wall DPM.

The disadvantage with both options is that waterproofing relies on deflection only, with no provision for secondary drainage (D2) or drying (D3) should water penetrate past the DPMs.

Figure 36: Wall/slab

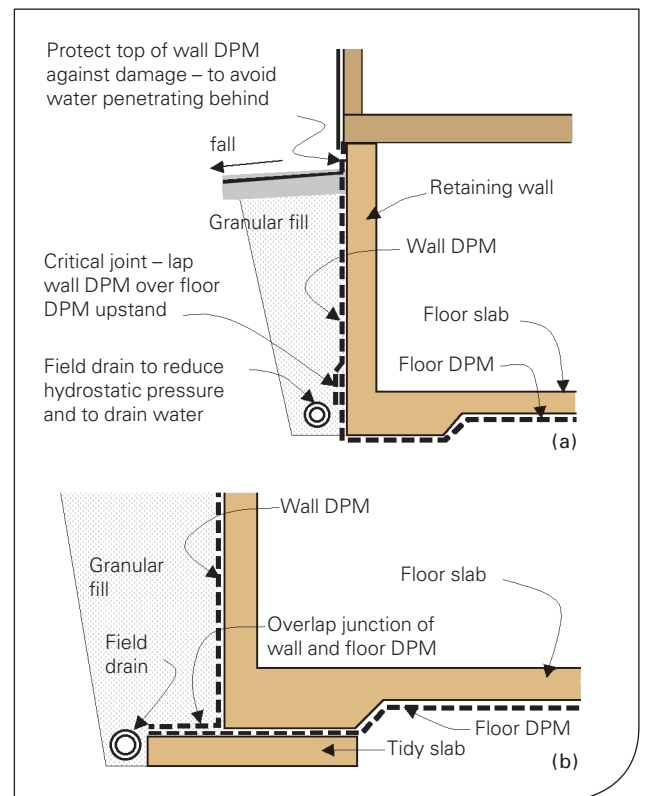

b) Separate inner wall

Figure 37 shows an inner wall separated by a cavity from a concrete retaining wall. This option can be useful where damp-proofing to the retaining wall is less reliable and a particularly dry interior-wall surface is required.

The system avoids the difficult junction between the wall and floor DPM, and provides protection in the form of:

- deflection (D1) by the wall and floor DPMs
- drainage (D2) as back-up should the wall DPM fail
- limited drying (D3) within the cavity
- durability (D4) by separating the timber walls from the concrete retaining walls.

Figure 37: Double wall with cavity

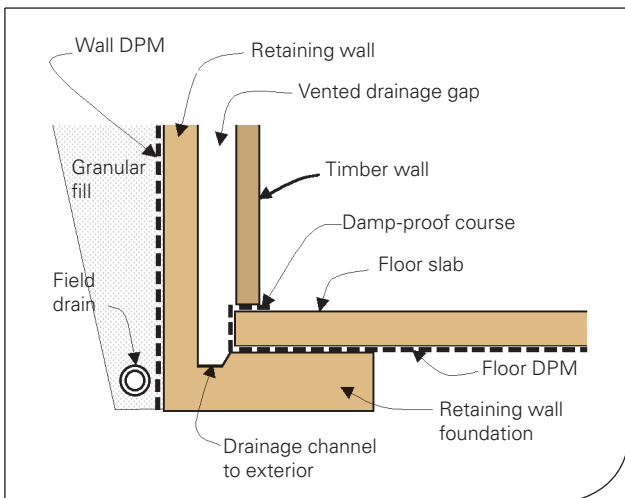

c) Retaining wall with raised timber floor

The option shown in Figure 38 can be useful where ground conditions may be particularly damp (although it will require deeper excavations to allow for subfloor clearances).

The system also avoids the need for a junction between the wall and floor DPM. It provides protection in the form of:

- deflection (D1) by the wall DPM
- limited drainage (D2) within the subfloor
- limited drying (D3) within the subfloor.

Figure 38: Retaining wall with raised floor

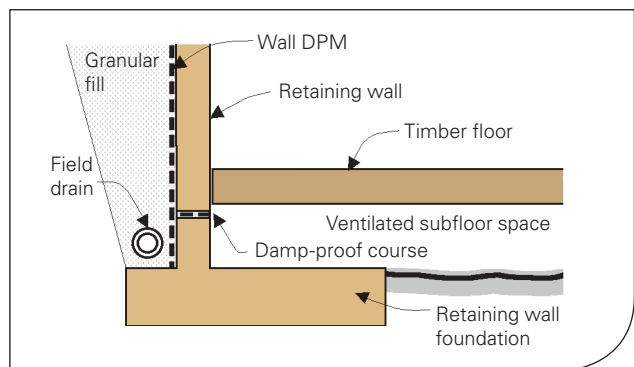

d) Retaining wall with double wall and timber floor

A final possibility is to use a combination of the types of retaining wall described above.

Figure 39 shows a separate timber wall and floor with a ventilated air space that allows moist air to vent to the outside.

This option offers all 4Ds by providing protection with:

- deflection (D1) by the DPM
- drainage (D2) within the cavity and the subfloor
- drying (D3) within the cavity and the subfloor
- durability (D4) by separating the timber walls from the concrete retaining walls.

This type of system minimises the risk of water entry, but does so at the expense of additional excavation and the loss of basement floor area.

Figure 39: Double wall and double floor

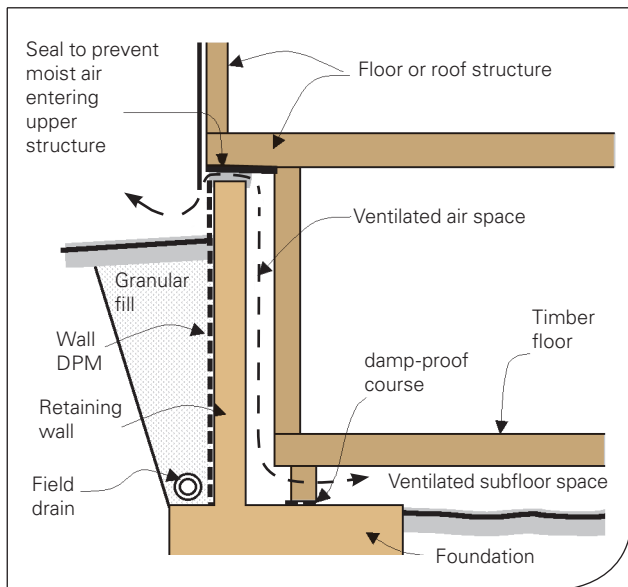

Glossary

The following provides a brief description of the meanings intended by terms used in this guide.

Acceptable Solutions (AS)	Examples of materials, components and construction methods which, if used, will result in compliance with the New Zealand Building Code. They are one way, but not the only way, of complying with the Building Code. Acceptable Solutions also serve as guidelines for alternative solutions.
Air seal	A continuous seal fitted around penetrations and joints (on the inner side of a wall) to prevent airflow through the wall.
Alternative solution (also known as a performance-based design)	A way of complying with the Building Code that does not use the prescribed methods and examples shown within the Compliance Documents.
Barrier wall	A wall that uses a cladding that is face-sealed with the aim of stopping water penetration at the outer surface. They include stucco, flush-finished fibre cement and EIFS.
Bird's beak	A water deflector at the bottom of a flashing, using a beak-shaped double fold, illustrated in E2/AS1.
Building consent authority	A territorial authority or a private body that is accredited to carry out building control functions such as issuing building consents, carrying out inspections and issuing code compliance certificates.
Building envelope	The term used to describe the outer wall and roof cladding system.
Compliance Documents	Documents (formerly known as Approved Documents) that set out prescribed methods of complying with specific clauses of the Building Code. They contain Acceptable Solutions and Verification Methods. Though optional, Compliance Documents are commonly followed in domestic building projects because they provide a straightforward recipe for building.
Conceptual design	An early design stage during which options are explored and changes may be easily made.
Control joint	A joint designed to allow movement to take place, so preventing damage such as cracking in flush-finished wall claddings.
Direct-fixed cladding	A cladding that is fixed directly through the building underlay to the framing (without a drained cavity).
Drained cavity	Cavity behind a wall cladding, as defined in E2/AS1.
Drained joint	A specialised type of negative joint that is designed to allow water in and then to drain it away again, commonly used in commercial claddings such as precast concrete panels.
DPC	Damp-proof course. Band of material used to inhibit the transfer of water liquid and vapour.
DPM	Damp-proof membrane. Sheet material used to inhibit the transfer of water liquid and vapour.

Kick-out	A water deflector at the bottom of a flashing, using a single fold, illustrated in E2/AS1.
Mass wall	A 'solid' wall (as distinct from a framed wall) that may be load-bearing or used as infilling within a primary structural frame.
Moisture load	The amount of water that needs to be allowed for when detailing joints and junctions. This will initially depend on particular site conditions, such as orientation and prevailing wind direction, but can be further modified by design features.
Monolithic claddings	Wall cladding systems that are flush-finished and rely on protective coatings for weatherproofing, for example, stucco, EIFS and flush-finished fibre-cement sheet.
Performance-based design (also known as an alternative solution)	A way of complying with the Building Code that does not use the prescribed methods and examples shown within the Compliance Documents.
Pressure-equalised rainscreens	Wall systems that are specially designed to equalise air pressures on both sides of the outer wall cladding. They tend to be sophisticated systems that are mainly used in specialised commercial design.
Pressure-moderation	The ability of cladding systems to moderate air pressures on either side of the cladding by allowing air 'leakage' through the cladding and/or by providing ventilation openings to cavities.
Rainscreen cavity claddings	Rainscreen claddings that are installed over a cavity as part of the weather-resisting system. They include traditional masonry veneer walls, and claddings on E2/AS1 drained cavities.
Rainscreen claddings	Describes the group of claddings (on framed walls) that may not form a total barrier to water – such as traditional claddings like weatherboards, or claddings over drained cavities.
Risk matrix	The means of determining the type of cladding and the requirement for a drained cavity in the Acceptable Solution for E2 External Moisture, E2/AS1.
Traditional rainscreens	Describes lap-jointed claddings (such as weatherboards) that are direct-fixed to wall framing with the small gaps at laps providing drainage and drying, rather than forming a total barrier to water.
Verification Method (VM)	Building Code compliance may be verified by calculations, laboratory tests or in situ tests. Where specific test methods are known, and practicable, these are listed as a Verification Method in a Compliance Document.
Water vapour pressures	Water vapour is a gas, and, like all gases (for example air), it exerts a pressure. Just as the pressure air exerts is called air pressure, so the pressure that the gas water vapour exerts is called water vapour pressure.
Wind barriers	A rigid barrier, such as a wall lining or similar, that resists air pressures.

Appendix A: Steps in the design process

Figure 41 illustrates the steps a designer can take when considering weathertightness using the information contained in this guide. Use the outline as a form of checklist or information guide.

It should prompt the designer in their decision-making and ensure important factors are appropriately considered as part of the process of designing for weathertightness to reduce the chances of water entering a building.

Figure 40: Weathertightness in the design process

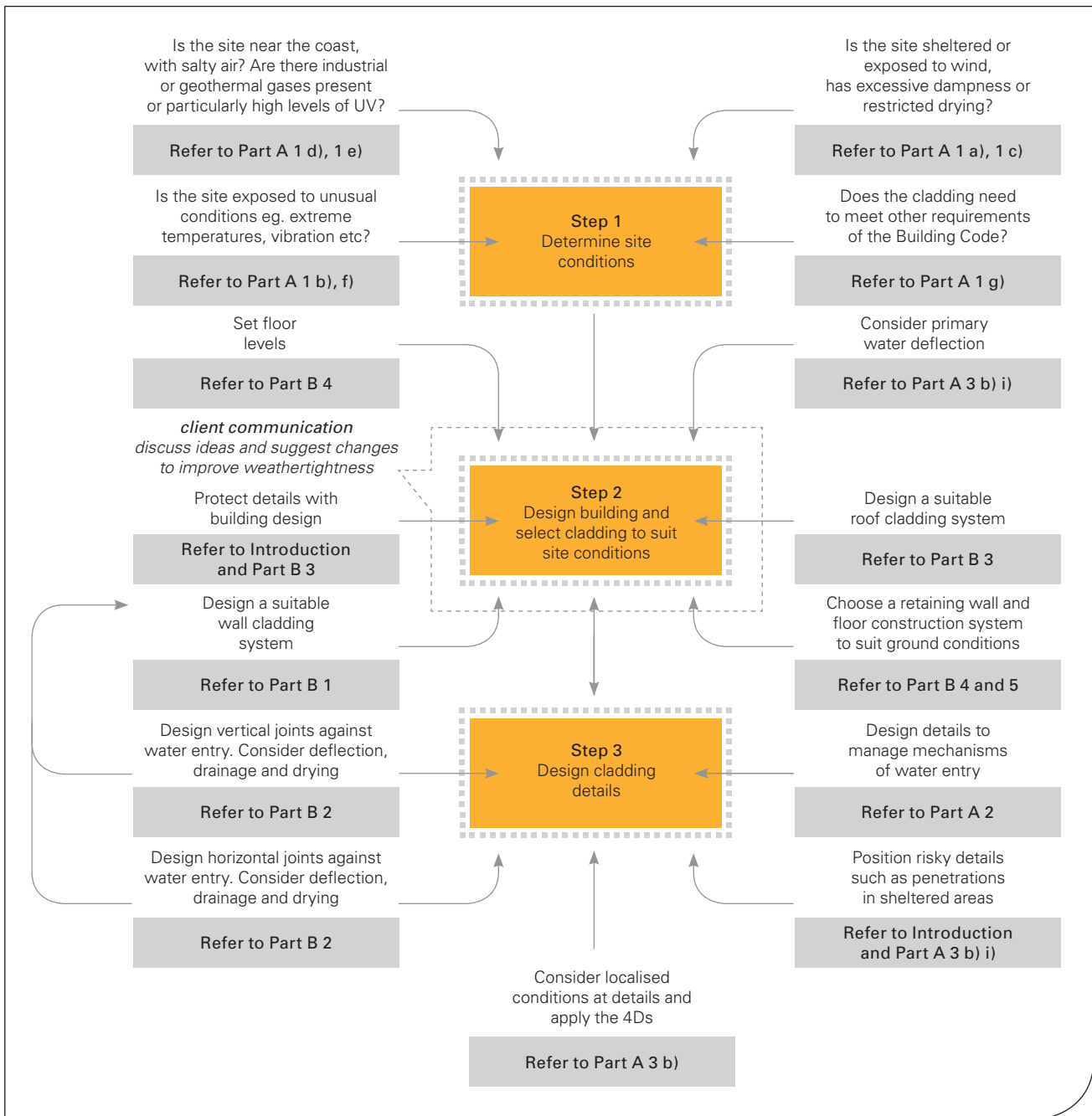

Appendix B: Simple example

The following is a simplified example of how information in this guide might be used when detailing and assessing weathertightness of specific construction details, in this case timber windows.

For simplicity, the window joinery is assumed to be weathertight, so it is the installation into the external walls that is being designed, detailed or assessed.

Early risk assessments – factors influencing general design decisions

Specific site conditions affecting weathertightness/durability (eg, wind, salt air, UV)?

Wind zone – NZS 3604 zone adjusted according to local site exposure

Localised shelter from trees or other buildings?
Can I see the horizon in the direction of prevailing wind and rain?
If exposed to prevailing winds, identify higher-risk windows.

General design – consider increasing eaves or adding other protection on exposed elevations, reassess window positioning.

History of use – are there similar windows installed in comparable situations and exposures that may be used (and later cited to the territorial authority) as examples of successful use?

For extensions – check the performance of existing windows in various exposures.
For new buildings – check performance of comparable situations in the local neighbourhood.

Check for D1 Deflection

General design

Check eaves and other roof projections. Check size and type of protection provided.
Judge nature of protection provided from eaves, pergolas etc.
Window heads below gable verges should be judged as exposed (reassess window positioning? additional shelter?).

Detailed design

Do window heads have projections and flashings to protect the top junctions?
Do windows in higher-risk positions need additional protection?

Part A 1
page 9

Part A 3 b) i)
page 18

Check for D2 Drainage

'Pushed' moisture – protection from moisture pushing into junctions by water momentum

Can the window-to-wall junction details hold, then drain safely to the outside, any water entering during storm-driven rain?

Check anti-capillary gaps/rebates. Are drainage gaps to the outside available? Check slopes on sill/head flashings and projections. Check flashing intersections (head/jamb, sill/jamb) – laps/projections/stop-ends.

Part A 3 b) ii)
page 20

Part A 2 b)
page 12

Part B 2
page 26

'Pulled' moisture – protection from moisture pulled into junctions by pressure differences

Check provision of **air seals** to prevent air leakage between window frames and wall framing. Continuous in same plane around the junctions? On dry side of wall? Suitable material?

(Flashing/deflection details at face of the installation form first stage rainscreen to deflect water away from joints. Space between wrapped and taped framing opening and window frame is second stage pressure-equalised cavity. Air seals form third stage.)

Part A 2 c)
page 12

Part B 2
page 26

Check for D3 Drying

Are windows in cavity walls? Will water entering cavities drain readily to outside?
Are windows face-fixed or recessed into walls? Are absorbent materials sealed?
Will water in a pressure-equalised junction cavity dry out rapidly?
Are ventilation gaps available to promote drying?

Part A 3 b) iii)
page 21

Part B 2 d)
page 30

Check for D4 Durability

Are flashing materials sufficiently durable for their location to comply with B2/AS1?

Are specified external timber finishes adequate? (Poorly finished softwood absorbs moisture, causing deformity in members, operating difficulties and mould growth. In cedar and redwood, the soft wood will be slowly eaten away.)

Part A 3 b) iv)
page 21

Appendix C: Additional resources

The Acceptable Solution for E2 External Moisture, E2/AS1, is available from the Department of Building and Housing (free download from www.dbh.govt.nz) or can be bought from the Victoria University Bookcentre in hard copy (www.vicbooks.co.nz or freephone 0800 370 370).

Further resources are available that can provide additional detail on some of the points raised in this guide and these should be consulted for further guidance. Some of these resources are listed below.

Exterior Wall Design: OAA Rain Penetration Control Practice Guide, June 2002. Ontario Association of Architects – Technical Practice Bulletin E.1.

New Zealand Metal Roof and Wall Cladding Code of Practice, 2003. New Zealand Metal Roofing Manufacturers Inc.

External moisture – A guide to using the risk matrix, June 2005. Department of Building and Housing (free download from www.dbh.govt.nz or call freephone 0800 242 243 for a hard copy)

BRANZ books (latest versions)

Stucco Good Practice Guide

Timber Cladding Good Practice Guide

Profiled Metal Wall Cladding Good Practice Guide

Weathertight Solutions, Volume One Weatherboards

Weathertight Solutions, Volume Two Stucco

BRANZ Bulletins

449: *Keeping water out – timber-framed walls*

448: *Domestic flashing installation*

435: *Weathertightness evaluation*

428: *Weathertightness do's and don'ts*

353: *Ground clearances*

304: *Flashing design*

Published in August 2006 by
Department of Building and Housing
PO Box 10-729
Wellington, New Zealand

This document is also available
on the Department's website:
www.dbh.govt.nz

ISBN: 0-478-29731-9 (document)
ISBN: 0-478-29732-7 (website)

