



Ministry of Business,
Innovation & Employment

C/AS4

**Acceptable Solution for Buildings with
Public Access and Educational Facilities
(Risk Group CA)**

For New Zealand Building Code Clauses
C1-C6 Protection from Fire

ARCHIVED



Using this Acceptable Solution

The Ministry of Business, Innovation and Employment may amend parts of this Acceptable Solution at any time. People using this Acceptable Solution should check on a regular basis whether new versions have been published. The current version can be downloaded from www.dbh.govt.nz/compliance-documents

Users should make themselves familiar with the preface to the New Zealand Building Code Handbook, which describes the status of Acceptable Solutions and explains other ways of achieving compliance.

Defined words (italicised in the text) are explained in the Building Code Clause A2 and in the Definitions section of this Acceptable Solution. Classified uses of buildings are explained in the Building Code Clause A1.

Enquiries about the content of this document should be directed to:



Ministry of Business, Innovation & Employment

The Ministry of Business, Innovation and Employment
PO Box 10-729, Wellington.
Telephone 0800 242 243
Fax 04 494 0290
Email: info@dbh.govt.nz

ISBN: 978-0-478-38174-0 (print)
ISBN: 978-0-478-38175-7 (electronic)

**Acceptable Solutions and Verification Methods are available
from www.dbh.govt.nz/compliance-documents**

New Zealand Government

© Ministry of Business, Innovation and Employment 2013

This document is protected by Crown copyright, unless indicated otherwise. The Ministry of Business, Innovation and Employment administers the copyright in this document. You may use and reproduce this document for your personal use or for the purposes of your business provided you reproduce the document accurately and not in an inappropriate or misleading context. You may not distribute this document to others or reproduce it for sale or profit.

The Ministry of Business, Innovation and Employment owns or has licences to use all images and trademarks in this document. You must not use or reproduce images and trademarks featured in this document for any purpose (except as part of an accurate reproduction of this document) unless you first obtain the written permission of the Ministry of Business, Innovation and Employment.

Status of C/AS4

This Acceptable Solution C/AS4, for buildings with public access and educational facilities (Risk Group CA), provides a means of compliance with the New Zealand Building Code Clauses C1-C6 Protection from Fire. It is issued under section 22 of the Building Act 2004 as a compliance document.

This Acceptable Solution is one way that can be used to show compliance with the New Zealand Building Code Clauses C1-C6 Protection from Fire. Other ways of complying with the Building Code are described, in general terms, in the preface of the New Zealand Building Code Handbook.

When can you use C/AS4

The Building Code Clauses C1-C6 Protection from Fire take effect on 10 April 2012. The Building Code Clauses C1-C6 Protection from Fire replace the Building Code Clauses C1-C4 Fire Safety on 9 April 2013.

This Acceptable Solution is effective from 15 February 2013. It can be used to show compliance with the Building Code Clauses C1-C6 Protection from Fire. It does not apply to building consents issued before 15 February 2013.

The Compliance Document for Fire Safety Amendment 9 may be used to show compliance with the Building Code Clauses C1-C4 Fire Safety for building consent applications made before 10 April 2013.

From 10 April 2013, the Compliance Document for Fire Safety Amendment 9 ceases to have effect.

Document History																
	Date	Alterations														
New document	Effective from 10 April 2012	C/AS4 is a new publication that can be used to show compliance with the Building Code Clauses C1-C6 Protection from Fire.														
Errata 1	Effective from 15 February 2013	<table border="0"> <tr> <td>pp. 7–8 References</td> <td>p. 58 3.15.5</td> </tr> <tr> <td>pp. 13–14 Definitions</td> <td>p. 89 4.17.7</td> </tr> <tr> <td>p. 22 1.3</td> <td>pp. 91–106 5.2.1, 5.3.2, 5.5.4, 5.7.6</td> </tr> <tr> <td>p. 25 Table 1.2</td> <td>and 5.8.1, Figures 5.3 and 5.7,</td> </tr> <tr> <td>pp. 26–27 2.2.1, 2.2.3</td> <td>Table 5.2</td> </tr> <tr> <td>p. 39 Figure 3.7</td> <td>p. 118 C4.1.2 and C5.1.1</td> </tr> <tr> <td>p. 44 Figure 3.12</td> <td></td> </tr> </table>	pp. 7–8 References	p. 58 3.15.5	pp. 13–14 Definitions	p. 89 4.17.7	p. 22 1.3	pp. 91–106 5.2.1, 5.3.2, 5.5.4, 5.7.6	p. 25 Table 1.2	and 5.8.1, Figures 5.3 and 5.7,	pp. 26–27 2.2.1, 2.2.3	Table 5.2	p. 39 Figure 3.7	p. 118 C4.1.2 and C5.1.1	p. 44 Figure 3.12	
pp. 7–8 References	p. 58 3.15.5															
pp. 13–14 Definitions	p. 89 4.17.7															
p. 22 1.3	pp. 91–106 5.2.1, 5.3.2, 5.5.4, 5.7.6															
p. 25 Table 1.2	and 5.8.1, Figures 5.3 and 5.7,															
pp. 26–27 2.2.1, 2.2.3	Table 5.2															
p. 39 Figure 3.7	p. 118 C4.1.2 and C5.1.1															
p. 44 Figure 3.12																

Contents

	Page		Page
References	7	4.7 Specific requirements for exhibition and retail areas	70
Definitions	9	4.8 Tiered seating	70
Part 1: General	19	4.9 Exitways	70
1.1 Introduction and scope	19	4.10 Intermittent activities	71
1.2 Using this Acceptable Solution	21	4.11 Protected shafts	73
1.3 Alterations and change of use to buildings	22	4.12 Long corridor subdivision	74
1.4 Calculating occupant loads	23	4.13 Floors	74
Part 2: Firecells, fire safety systems and fire resistance ratings	26	4.14 Subfloor spaces	76
2.1 Provision of firecells	26	4.15 Concealed spaces	76
2.2 Fire safety systems	26	4.16 Closures in fire and smoke separations	80
2.3 Fire resistance ratings	29	4.17 Interior surface finishes, floor coverings and suspended flexible fabrics	87
Part 3: Means of escape	31	4.18 Building services plant	89
3.1 General principles	31	Part 5: Control of external fire spread	90
3.2 Number of escape routes	33	5.1 Fire separation for buildings with more than one title	90
3.3 Height and width of escape routes	33	5.2 Horizontal fire spread from external walls	91
3.4 Length of escape routes	38	5.3 FRRs of external walls	91
3.5 Escape from basements	43	5.4 Small openings and fire resisting glazing	92
3.6 Open paths	44	5.5 Table method for external walls	94
3.7 Special cases of open paths	45	5.6 Horizontal fire spread from roofs and open sided buildings	98
3.8 Dead ends	49	5.7 Vertical fire spread	101
3.9 Exitways	49	5.8 Exterior surface finishes	106
3.10 Control of exitway activities	52	Part 6: Firefighting	107
3.11 External escape routes	53	6.1 Fire service vehicular access	107
3.12 Final exits	56	6.2 Information for firefighters	107
3.13 Single escape routes	56	6.3 Access within the building for firefighting and rescue operations	108
3.14 This paragraph deliberately left blank	57	6.4 Firefighting facilities	108
3.15 Doors subdividing escape routes	57	Part 7: Prevention of fire occurring	109
3.16 Signs	63	7.1 Solid fuel appliances	109
Part 4: Control of internal fire and smoke spread	64	7.2 Gas-burning appliances	110
4.1 Firecells	64	7.3 Oil-fired appliances	110
4.2 Glazing in fire and smoke separations	64	7.4 Downlights	110
4.3 Structural stability during fire	65	7.5 Open fires	111
4.4 Fire stopping	67		
4.5 Firecell construction	67		
4.6 Specific requirements for sleeping areas	68		

	Page
Appendix A (normative): Fire safety systems	116
Appendix B (normative): Fire sprinkler systems	117
Appendix C (normative): Test methods	118
Index	121

References

For the purposes of New Zealand Building Code compliance, the New Zealand and other Standards, and other documents referred to in this Acceptable Solution (primary reference documents) shall be the editions, along with their specific amendments, listed below. Where the primary reference documents refer to other Standards or other documents (secondary reference documents), which in turn may also refer to other Standards or other documents, and so on (lower order reference documents), then the applicable version of these secondary and lower order reference documents shall be the version in effect at the date this Acceptable Solution was published.

Errata 1
Feb 2013

Standards New Zealand

		Where quoted
NZS/BS 476:-	Fire tests on building materials and structures	
Part 21: 1987	Methods for determination of the fire resistance of loadbearing elements of construction	C5.1.1
Part 22: 1987	Methods for determination of the fire resistance of non-loadbearing elements of construction	C5.1.1
AS/NZS 1668:-	The use of ventilation and air conditioning in buildings	
Part 1: 1998	Fire and smoke control in multi-compartment buildings <i>Amend: 1</i>	Table 2.1, A2.1.1
AS/NZS 2918: 2001	Domestic solid fuel burning appliances – installation	7.1.1, 7.1.2, 7.5.5, 7.3.3, 7.5.10 Comment, 7.5.12, Figure 7.2
NZS 4232:-	Performance criteria for fire resisting closures	
Part 2: 1988	Fire resisting glazing systems	Definitions
NZS 4332: 1997	Non-domestic passenger and goods lifts	6.4.3
NZS 4510: 2008	Fire hydrant systems for buildings <i>Amend: 1</i>	Table 2.1, A2.1.1
NZS 4512: 2010	Fire detection and alarm systems in buildings	2.2.2, Table 2.1, 6.2.1, A2.1.1, C6.1.6
NZS 4515: 2009	Fire sprinkler systems for life safety in sleeping occupancies (up to 2000 m ²)	Definitions, 2.3.13, 6.2.1, B3.1.1
NZS 4520: 2010	Fire resistant doorsets	4.2.4, 4.16.6, C6.1.1
NZS 4541: 2007	Automatic fire sprinkler systems <i>Amend: 1</i>	Definitions, Table 2.1, 4.6.3, 5.2.2, 6.2.1, B2.1.1
NZS 5261: 2003	Gas installation <i>Amend: 1, 2</i>	7.2.1, 7.2.2

Standards Australia

AS 1366:-	Rigid cellular plastics sheets for thermal insulation	
Part 1: 1992	Rigid cellular polyurethane (RC/PUR) <i>Amend: 1</i>	4.17.2
Part 2: 1992	Rigid cellular polyisocyanurate (RC/PIR)	4.17.2
Part 3: 1992	Rigid cellular polystyrene – moulded (RC/PS-M) <i>Amend: 1</i>	4.17.2
Part 4: 1989	Rigid cellular polystyrene – extruded (RC/PS-E)	4.17.2

AS 1530:-	Methods for fire tests on building materials, components and structures	
Part 1: 1994	Combustibility test for materials	Definitions, C4.1.1
Part 2: 1993	Test for flammability of materials	4.17.8, 4.17.9, C3.1
Part 4: 2005	Fire-resistance tests of elements of building construction	4.5.9, C5.1.1
AS 1691: 1985	Domestic oil-fired appliances – installation	7.3.1, 7.3.2
AS 4072:-	Components for the protection of openings in fire-resistant separating elements	
Part 1: 2005	Service penetrations and control joints	C5.1.2
<i>Amend: 1</i>		

Errata 1
Feb 2013

International Standards Organisation

ISO 5660:-	Reaction-to-fire tests – Heat release, smoke production and mass loss rate	
Part 1: 2002	Heat release rate (cone calorimeter method)	C4.1.2, C7.1.1, C7.1.2
Part 2: 2002	Smoke production rate (dynamic measurement)	C4.1.2
ISO 9239:-	Reaction to fire tests for flooring	
Part 1: 2010	Determination of the burning behaviour using a radiant heat source	4.17.3, Table 4.2, C2.1
ISO 9705: 1993	Fire tests – Full scale room test for surface products	C4.1.2

Errata 1
Feb 2013

Errata 1
Feb 2013

European Standards

BS EN 12101	Smoke and heat control systems	
Part 1: 2005	Specification for smoke barriers	Definitions

Errata 1
Feb 2013

Building Research Establishment (UK)

BRE Defect Action Sheet DAS 131: May 1989	External walls: Combustible external plastics insulation: Horizontal fire barriers	5.7.18 Comment
BRE Report 135: 1988	Fire performance of external thermal insulation for walls in multi-storey buildings. Rogowski B.F., Ramaprasad R., Southern J.R.	5.7.18 Comment

National Fire Protection Association of America

NFPA 285: 1998	Standard method of test for the evaluation of flammability characteristics of exterior non-load-bearing wall assemblies containing components using the intermediate scale, multi-storey test apparatus	5.8.2
----------------	---	-------

American Society for Testing and Materials

ASTM D 2898: 2010	Standard practice for accelerated weathering of fire-retardant-treated wood for fire testing	C7.1.3
-------------------	--	--------

New Zealand Legislation

Education (Early Childhood Services) Regulations 2008		Table 1.2
Fire Safety and Evacuation of Buildings Regulations 2006		Definitions
Hazardous Substances and New Organisms Act 1996		1.1.5

Definitions

The full list of definitions for italicised words may be found in the New Zealand Building Code Handbook.

Access route A continuous route that permits people and goods to move between the apron or *construction* edge of the *building* to spaces within a *building*, and between spaces within a *building*.

Accessible Having features to permit use by *people with disabilities*.

Accessible route An *access route* usable by *people with disabilities*. It shall be a continuous route that can be negotiated unaided by a wheelchair user. The route shall extend from street *boundary* or car parking area to those spaces within the *building* required to be *accessible* to enable *people with disabilities* to carry out normal activities and processes within the *building*.

Adjacent building A nearby *building*, including an adjoining *building*, whether or not erected on *other property*.

Basement Any *firecell* or part of a *firecell* below the level of the lowest *final exit*.

Comment:

Because *fire safety systems* are increased with increases in *escape height*, the precautions for *basements* increase with *basement* depth. Thus a single floor *building* with one *basement* level is treated as a two floor *building*, a single floor *building* with three *basement* levels as a four floor *building*.

Boundary means any *boundary* that is shown on a survey plan that is approved by the Surveyor-General and deposited with the Registrar-General of Land, whether or not a new title has been issued.

Building has the meaning given to it by sections 8 and 9 of the Building Act 2004.

Comment:

Notwithstanding the definition of *building*, a number of separated *buildings* cannot be taken as a single *firecell* for the purposes of this Acceptable Solution.

Building Act 2004 (the Building Act) means the principal legislation dealing with building controls in New Zealand.

Comment:

The *Building Act* applies to the construction, alteration, and demolition of new and existing buildings throughout New Zealand.

Building Code means the regulations made under section 400 of the *Building Act 2004*.

Building consent means consent to carry out *building* work granted by a *building consent authority* under section 49 of the *Building Act 2004*.

Building consent authority has the meaning ascribed to it by section 7 of the *Building Act 2004*.

Building element Any structural and non-structural component or assembly incorporated into or associated with a *building*. Included are *fixtures*, services, *drains*, permanent mechanical installations for access, glazing, partitions, ceilings and temporary supports.

Building height Building height means the vertical distance between the floor level of the lowest *occupied space* above the ground and the top of the highest occupied floor, but not including spaces located within or on the roof that enclose stairways, lift shafts, or machinery rooms.

Cavity barrier A *construction* provided to close openings within a *concealed space* against the passage of *fire*, or to restrict the spread of *fire* within such spaces.

Chimney A *non-combustible* structure which encloses one or more *flues*, *fireplaces* or other heating appliances.

Chimney back The *non-combustible* wall forming the back of a *fireplace*.

Chimney breast The front *fireplace* wall *construction* above the *fireplace* opening.

Chimney jambs The side walls of a *fireplace*.

Combustible See *non-combustible*.

Concealed space Any part of the space within a *building* that cannot be seen from an *occupied space*.

Comment:

This term includes any ceiling space, roof space, space under a raised floor (such as computer rooms, floors, or stages), plenums, spaces under a tiered floor, "left-over spaces" created when some structural element or the like has been covered in; small service or duct spaces within the volume of a *firecell* and the like, but not a *protected shaft*.

Construct in relation to a *building*, includes to design, build, erect, prefabricate, and relocate the *building*; and construction has a corresponding meaning.

Dead end That part of an open path where escape is possible in only one direction.

Comment:

A *dead end* ceases to exist where the *escape route* reaches a point in the *open path* which offers alternative directions of travel, or at a *final exit* or an *exitway*.

Doorset A complete assembly comprising a door leaf or leaves including any glazed or solid panels adjacent to or over the leaves within the door frame including hardware or other inbuilt features; and a door frame, if any, with its fixings to the wall and, for a sliding or tilting door, all guides and their respective fixings to the lintel, wall or sill.

Early childhood centre (ECC) means premises used regularly for the education or care of 3 or more children (not being children of the persons providing the education or care, or children enrolled at a school being provided with education or care before or after school) under the age of six—

a) by the day or part of a day; but

b) not for any continuous period of more than seven days.

ECC does not include home based early childhood services.

Escape height The height between the floor level in the *firecell* being considered and the floor level of the required *final exit* which is the greatest vertical distance above or below that *firecell*.

Comment:

1. It is necessary only to use the greatest height to the exits required for the *firecell* being considered, even though the *building* may have other *final exits* at lower or higher levels.
2. Where the *firecell* contains *intermediate floors*, or upper floors within *household units* the *escape height* shall be measured from the floor having the greatest vertical separation from the *final exit*.

Escape route A continuous unobstructed route from any *occupied space* in a *building* to a *final exit* to enable occupants to reach a *safe place*, and shall comprise one or more of the following: *open paths* and *safe paths*.

Comment:

Doors are not obstructions in an escape route provided they comply with C/AS1 and D1/AS1.

Exitway All parts of an *escape route* protected by *fire* or *smoke separations*, or by distance when exposed to open air, and terminating at a *final exit*.

External wall Any exterior face of a *building* within 30° of vertical, consisting of *primary* and/or *secondary elements* intended to provide protection against the outdoor environment, but which may also contain *unprotected areas*.

Comment:

A roof is an *external wall* if within 30° of the vertical.

Final exit The point at which an *escape route* terminates by giving direct access to a *safe place*.

Comment:

Final exits are commonly the external doors from a ground floor, but this applies only if such doors open directly onto a *safe place*. If a *safe place* can be reached only by passing down an alley, or across a bridge, then the *final exit* is not reached until the end of such an alley or bridge. *Final exits*, therefore, should be seen strictly as a point of arrival, rather than as any particular element of a *building*. They are determined entirely by the definition of *safe place*.

Fire The state of combustion during which flammable materials burn producing heat, toxic gases, or smoke or flame or any combination of these.

Firecell Any space including a group of contiguous spaces on the same or different levels within a *building*, which is enclosed by any combination of *fire separations*, *external walls*, roofs, and floors.

Comment:

Floors, in this context, includes ground floors, and those in which the underside is exposed to the external environment (eg, when cantilevered). Note also that internal floors between *firecells* are *fire separations*.

Fire damper A device with a specified *FRR* complete with fixings and operating mechanism for automatically closing off an airway where it passes through a *fire separation*.

Comment:

An airway may be a duct, plenum, ceiling space, roof space or similar *construction* used for the passage of ventilating air.

Fire door A doorset, single or multi-leaf, having a specific *fire resistance rating*, and in certain situations a smoke control capability, and forming part of a *fire separation*. The door, in the event of *fire*, if not already closed, will close automatically and be self latching.

Fire hazard means the danger of potential harm and degree of exposure arising from—

- a) the start and spread of *fire*; and
- b) the smoke and gases that are generated by the start and spread of *fire*.

Fire load The sum of the net calorific values of the *combustible* contents which can reasonably be expected to burn within a *firecell*, including furnishings, built-in and removable materials, and *building elements*. The calorific values shall be determined at the ambient moisture content or humidity. (The unit of measurement is MJ.)

Fireplace A space formed by the *chimney back*, the *chimney jambs*, and the *chimney breast* in which fuel is burned for the purpose of heating the room into which it opens.

Fire resistance rating (FRR) The term used to describe the minimum *fire* resistance required of *primary* and *secondary elements* as determined in the *standard test* for *fire* resistance, or in accordance with a specific calculation method verified by experimental data from standard *fire* resistance tests. It comprises three numbers giving the time in minutes for which each of the criteria *structural adequacy*, *integrity* and *insulation* are satisfied, and is presented always in that order.

Comment:

Examples of FRRs are:

- a) 60/60/30 indicating *structural adequacy* 60 minutes, *integrity* 60 minutes, *insulation* 30 minutes.
- b) 30/-/- indicating *structural adequacy* 30 minutes, but no time requirement for *integrity* or *insulation*.
- c) 60/30/x indicating *structural adequacy* of 60 minutes, *integrity* of 30 minutes, and a requirement for *insulation*.

Fire resisting closure A *fire* rated device or assembly for closing an opening through a *fire separation*.

Comment:

A *fire resisting closure* is intended to include *fire doors*, *fire windows* or access panels. In this context the opening may be used to permit passage of people or goods, or to transmit light, but does not include an opening to permit the passage of *building services*.

Fire resisting glazing Fixed or openable glazing, complete with frame and fixings, mullions, transoms and glazing beads, with a specified *FRR* and complying with NZS 4232: Part 2.

Comment:

1. The requirement for *fire resisting glazing* will not be met by ordinary window glass, or safety glasses, but rather by wired glass, or by special *fire* resisting glass shown by test to perform. The nature and design of the frames also have an effect on the performance of *fire resisting glazing*.
2. Openable glazing is required by NZS 4232 Part 2 to be fitted with an automatic device which, in the event of *fire*, will close and latch the window sash.

Fire retardant A substance or a treatment, incorporated in or applied to a material, which suppresses or delays the combustion of that material under specified conditions.

Fire safety systems means the combination of all active and passive protection methods used in a *building* to—

- (a) warn people of an emergency; and
- (b) provide for safe evacuation; and
- (c) provide for access by, and the safety of, firefighters; and
- (d) restrict the spread of *fire*; and
- (e) limit the impact of *fire* on structural stability

Fire separation Any *building element* which separates *firecells* or *firecells* and *safe paths*, and provides a specific *fire resistance rating*.

Fire shutter A *fire* rated device, complete with fixings and operating mechanism, for automatically closing off an opening in a *fire separation* or *protected shaft*.

Fire stop A material or method of *construction* used to restrict the spread of *fire* within or through *fire separations*, and having a *FRR* no less than that of the *fire separation*.

Comment:

Fire stops are mainly used to seal around *penetrations*, but can also be used to seal narrow gaps between *building elements*.

Fixture An article intended to remain permanently attached to and form part of a *building*.

Flammability index (FI) That index number for flammability, which is determined according to the *standard test* method for flammability of thin flexible materials.

Flue The passage through which the products of combustion are conveyed to the outside.

Flue liner Pipes or linings of *fire clay*, metal or *fire brick* that surrounds *flues*.

Flue system A series of interconnecting *flue* pipe casings which form a safe passage (*flue*) for conveying products of combustion from within an appliance to the outside of a *building* or structure.

Foamed plastics *Combustible* foamed plastic polymeric materials of low density (typically less than 100 kg/m³) and are classified as cellular polymers which are manufactured by creating a multitude of fine void (typically 90 to 98%) distributed more or less uniformly throughout the product. Examples of *foamed plastics* are latex foams, polyethylene foams, polyvinyl chloride foams, expanded or extruded polystyrene foams, phenolic foams, ureaformaldehyde foams, polyurethane foams and polychloroprene foams.

Comment:

1. *Foamed plastics* may be rigid or flexible, but rigid foams are the most common in *building* products. When burnt they tend to generate high levels of heat energy (kJ/kg) and varying quantities of smoke and other toxic gases depending on the nature and volume of the particular product.
2. Where doubt exists as to whether a *building* material is *foamed plastics*, an opinion should be sought from a *person* or organisation with appropriate skill and experience in *fire* engineering. That opinion should be included with the *building consent* application to the *building consent authority*.

Group Number The classification number for a material used as a finish, surface, lining, or attachment to a wall or ceiling within an *occupied space* and determined according to the *standard test* methods for measuring the properties of lining materials.

Comment:

The method for determining a Group Number is described in C/VM2 Appendix A.

Group sleeping area A *firecell* containing communal sleeping accommodation for a specified number of people who may or may not be known to one another. Partial subdivision within the *firecell* is permitted with specific limitation including that no *occupied space* is fully enclosed and all *occupied spaces* are open and available to all occupants at any time. A *group sleeping area firecell* may include spaces for associated direct support functions, such as hygiene facilities and tea making (not cooking) activities, for use by the occupants. It does not include spaces, such as waiting rooms, lounges, dining rooms or kitchens, providing a communal service function for all occupants.

Comment:

1. Examples of *group sleeping area firecells* are dormitories, hospital wards, *wharehenui*, backpacker hostels and ski lodges.
2. The maximum number of people permitted in a *group sleeping area firecell*, and the permitted form of subdivision, will depend on the ability of the occupants to react to the presence of *fire* and escape to a *safe place*.

Handrail A rail to provide support to, or assist with the movement of a *person*.

Hazardous Creating an unreasonable risk to people of bodily injury or deterioration of health.

Hazardous substance has the meaning ascribed to it by section 2 of the Fire Service Act 1975 and section 2 of the Hazardous Substances and New Organisms Act 1996.

Hearth The insulating floor under the *fire* and in front and at the sides of the *fireplace*.

Hold-open device A device which holds a *smoke control door* or *fire door* open during normal use, but is released by deactivating the device by an automatic *fire* detection system, allowing the door to close automatically under the action of a self-closing device.

Household unit

(a) means a *building* or group of *buildings*, or part of a *building* or group of *buildings*, that is—

- (i) used, or intended to be used, only or mainly for residential purposes; and
- (ii) occupied, or intended to be occupied, exclusively as the home or residence of not more than 1 household; but

(b) does not include a hostel, boarding house, or other specialised accommodation.

HVAC An abbreviation for heating, ventilating and airconditioning.

Insulating material A material that has a thermal conductivity of less than 0.07 W/mK.

Insulation In the context of *fire* protection, the time in minutes for which a prototype specimen of a *fire separation*, when subjected to the *standard test* for *fire* resistance, has limited the transmission of heat through the specimen.

Integrity In the context of *fire* protection, the time in minutes for which a prototype specimen of a *fire separation*, when subjected to the *standard test* for *fire* resistance, has prevented the passage of flame or hot gases.

Comment:

The precise meaning of *integrity* depends on the type of *building elements* being treated and how it is defined in the *standard test* being used.

Intended use In relation to a *building*,—

- (a) includes any or all of the following:
 - (i) any reasonably foreseeable occasional use that is not incompatible with the *intended use*;
 - (ii) normal maintenance;
 - (iii) activities undertaken in response to *fire* or any other reasonably foreseeable emergency; but
- (b) does not include any other maintenance and repairs or rebuilding.

Intermediate floor Any upper floor within a *firecell* which because of its configuration provides an opening allowing smoke or *fire* to spread from a lower to an upper level within the *firecell*.

Comment:

1. Upper floors within *household units* need not meet the specific *fire* safety requirements which apply to *intermediate floors* in all other situations.
2. An *intermediate floor* may be open to the *firecell* or enclosed with non-*fire* rated *construction*. If enclosed with *fire* rated walls another *firecell* is created.
3. *Household units* occur only in *risk groups* SM and SH. Life safety provisions are governed by the limitations in permitted *open path* lengths.
4. *Risk groups* SM, SI, CA, WB, WS and VP allow limited area intermediate floors of 20% or 40% of the floor area depending on other fire safety requirements. In other situations C/VM2 is to be used.

Life rating The *fire resistance rating* to be applied to elements of *construction* that allows movement of people from their location in a *building* to a *safe place*.

Means of escape from fire In relation to a *building* that has a floor area,—

- a) means continuous unobstructed routes of travel from any part of the floor area of that *building* to a place of safety; and

- b) includes all active and passive protection features required to warn people of *fire* and to assist in protecting people from the effects of *fire* in the course of their escape from the *fire*.

Comment:

Means of escape include features providing visibility in *escape routes* complying with F6 and signs complying with F8.

Non-combustible Materials shall be classified as *combustible* or *non-combustible* when tested to AS 1530 Part 1.

Notional boundary The *boundary* which, for *fire* safety purposes, is assumed to exist between two *buildings* on the same property under a single land title.

Comment:

A *notional boundary* may be located anywhere between the two *buildings* on the same property using the following rules:

1. The *notional boundary* is assumed to exist in the space between the *buildings* and is positioned so that one of the *buildings* would comply with the provisions for space separation having regard to the amount of its *unprotected area*. In practice, if one of the *buildings* is existing, the position of the *boundary* will be set by the space separation factors for that *building*.
2. The siting of the new *building*, or the second *building* if both are new, can then be checked to see that it also complies, using the *notional boundary* as the *relevant boundary* for the second *building*. (Once the *notional boundary* is set for the first *building* it becomes the *relevant boundary* for the second (new) *building* and does not move).

Occupant load The greatest number of people likely to occupy a particular space within a *building*. It is determined by:

- a) dividing the total floor area by the m² per person (occupant density) for the activity being undertaken, or
- b) for sleeping areas, counting the number of sleeping (or care) spaces, or
- c) for fixed seating areas, counting the number of seats.

Comment:

See Paragraphs 1.4.5 (for fixed seating) and 1.4.6 (for sleeping areas) where appropriate.

Errata 1
Feb 2013

Occupied space Any space within a *building* in which a *person* will be present from time to time during the *intended use* of the *building*.

Open path That part of an *escape route* (including *dead ends*) within a *firecell* where occupants may be exposed to *fire* or smoke while making their escape.

Open space Open space means land on which there are, and will be, no *buildings* and which has no roof over any part of it other than overhanging eaves.

Other property Any land or *buildings* or part of any land or *buildings*, that are:

- a) not held under the same *allotment*; or
- b) not held under the same *ownership*; and includes a *road*.

Owner In relation to land and any *buildings* on the land,—

- (a) means the *person* who—
 - (i) is entitled to the rack rent from the land; or
 - (ii) would be so entitled if the land were let to a tenant at a rack rent; and
- (b) includes—
 - (i) the *owner* of the fee simple of the land; and
 - (ii) any *person* who has agreed in writing, whether conditionally or unconditionally, to purchase the land or any leasehold estate or interest in the land or to take a lease of the land and who is bound by the agreement because the agreement is still in force.

Penetration A pipe, cable or duct passing through an opening in a *fire separation*.

People with disabilities People whose ability to use *buildings* is affected by mental, physical, hearing or sight impairment.

Place of safety Place of safety means either—

- (a) a *safe place*; or
- (b) a place that is inside a *building* and meets the following requirements:
 - (i) the place is constructed with *fire separations* that have fire resistance sufficient to withstand *burnout* at the point of the *fire source*; and
 - (ii) the place is in a *building* that is protected by an automatic fire sprinkler system that complies with NZS 4541 or NZS 4515 as appropriate to the *building's use*; and
 - (iii) the place is designed to accommodate the intended number of persons; and
 - (iv) the place is provided with sufficient means of escape to enable the intended number of persons to escape to a *safe place* that is outside a *building*.

Primary element A *building element* providing the basic loadbearing capacity to the structure, and which if affected by *fire* may initiate instability or premature structural collapse.

Comment:

Suspended floors in multi-storey *buildings* are *primary elements*.

Property rating The *fire resistance rating* to be applied to elements of *construction* that allows for protection of *other property*.

Protected shaft A space, other than a *safe path*, enclosed by *fire separations* or *external walls* used to house *building services*, lifts, or conveyors which pass from one *firecell* to another.

Railway line has the meaning ascribed to it by section 4 of the Railways Act 2005.

Relevant boundary Relevant *boundary* means the *boundary* of an *allotment* that is *other property* in relation to the *building* in question and from which is measured the separation between the *building* and that *other property*; and for the *external wall* of any *building*, the *relevant boundary* is the nearest of—

- (a) a *boundary* of a freehold *allotment*, except that if the *other property* is a *road*, *railway line*, or public *open space*, the *relevant boundary* is the *boundary* on the far side of that *other property*; or
- (b) a *boundary* of a cross-lease or a company lease or a licence, except that if the *other property* is *open space* to which the lessee or licensee of the *building* in question has an exclusive right of access and occupation or to which 2 or more occupiers of the *building* in question have rights of access and occupation, the *relevant boundary* is the *boundary* on the far side of that *other property*; or
- (c) a *boundary* shown on a unit plan (but excluding a *boundary* between a principal unit and its accessory unit), except that if the *other property* is open space and is common property, the *relevant boundary* is the *boundary* on the far side of that *other property*.

Comment:

1. Where an easement, such as a right of way, occurs within an *allotment*, the *relevant boundary* shall remain the same as if the easement did not exist.
2. *Boundaries* within a cross-lease or company lease or licence are shown on a survey plan. In some cases the *boundary* is the *external wall* or roof of a *building*.
3. The unit title *boundaries* of principal units, accessory units, and common property are shown in the unit plan. A *boundary* is frequently an internal or *external wall*, an upper floor, or the roof of a *building*.
4. A wall along a *boundary* between two *allotments* is called a “party wall” when the *owners* of the *allotments* each have legal rights in respect of that wall registered by way of easements on one or both titles. An internal wall between cross-leases, company leases, or unit titles, or between one of them and common property, is not generally called a party wall but in that case also the lessees, unit title holders, or corporate body concerned each have legal rights in respect of that wall. Such a wall separates areas which are *other property* in relation to each other, but the wall itself is part of each property. The *fire* protection consequence of that legal concept is that such a wall can be regarded as a *fire separation* providing protection against horizontal *fire* spread in each direction. In other words, that wall may provide the appropriate *FRR* instead of each property having its own wall of that *FRR*.

Risk group The classification of a *building* or *firecells* within a *building* according to the use to which it is intended to be put.

Road This term has the meaning ascribed to it by section 315 of the Local Government Act 1974 and includes a public place and also includes a motorway.

Safe path That part of an *exitway* which is protected from the effects of *fire* by *fire separations*, *external walls*, or by distance when exposed to open air.

Safe place A place, outside of and in the vicinity of a single *building* unit, from which people may safely disperse after escaping the effects of a *fire*. It may be a place such as a street, *open space*, public space or an *adjacent building* unit.

Comment:

The Fire Safety and Evacuation of Buildings Regulations 2006 use the term *place of safety* and allow the *place of safety* to be within the *building* provided that it is protected with a sprinkler system. In this Acceptable Solution a *place of safety* can only be within a *building* in Risk Group S1.

Secondary element A *building element* not providing load bearing capacity to the structure and if affected by *fire*, instability or collapse of the *building* structure will not occur.

Smokecell A space within a *building* which is enclosed by an envelope of *smoke separations*, or *external walls*, roofs, and floors.

Smoke control door A *doorset* that complies with Appendix C, C6.1.2 of this acceptable solution.

Smoke lobby That portion of an *escape route* within a *firecell* that precedes a *safe path* or an *escape route* through an adjoining *building* which is protected from the effects of smoke by *smoke separations*.

Smoke separation Any *building element* able to prevent the passage of smoke between two spaces. *Smoke separations* shall:

- a) Be a smoke barrier complying with BS EN 12101 Part 1, or
- b) Consist of rigid *building elements* capable of resisting without collapse:
 - i) a pressure of 0.1 kPa applied from either side, and
 - ii) self weight plus the intended vertically applied live loads, and
- c) Form an imperforate barrier to the spread of smoke, and

- d) Be of *non-combustible construction*, or achieve a *FRR* of 10/10/-, except that *non-fire resisting glazing* may be used if it is toughened or laminated *safety glass*.

Comment:

The pressure requirement is to ensure rigidity and is not a smoke leakage requirement.

Walls and floors, whether *constructed* of sheet linings fixed to studs or joists, or of concrete, glazing, metal or fired clay, need only be inspected by someone experienced in *building construction* to judge whether the *construction* is tight enough to inhibit the passage of smoke.

Item d) is intended to ensure that the *smoke separation* will continue to perform as an effective barrier when exposed to *fire* or smoke for a short period during *fire* development.

There is no requirement for *smoke control doors* or other closures in *smoke separations* to meet the provisions of item d).

Stability In the context of *fire* protection is the support provided to a *building element* having a *FRR*, intended to avoid premature failure due to structural collapse as a result of applied load, dead and live loads or as a result of any additional loads caused by *fire*.

Stairway A series of steps or stairs with or without landings, including all necessary *handrails* and giving access between two different levels.

Standard test A test method which is recognised as being appropriate for the *fire* protection properties being assessed.

Comment:

A list of *standard test* methods is given in Appendix C.

Structural adequacy In the context of the standard test for *fire* resistance, is the time in minutes for which a prototype specimen has continued to carry its applied load within defined deflection limits.

Comment:

The *fire* design load should be as specified in B1/VM1.

Suite A *firecell* providing residential accommodation for the exclusive use of one *person* or of several people known to one another. It comprises one or more rooms for sleeping and may include spaces used for associated domestic activities such as hygiene and cooking.

Comment:

1. Bed numbers are limited to six in *risk group* SI or 12 in *risk group* SM in accordance with C/AS2 and C/AS3. Examples may be found in hotels, motels and residential care facilities, such as old people's homes or in hospices providing temporary family accommodation.
2. It is assumed that the social cohesion of the occupants by virtue of the personal relationship (as family members, friends or associates) would ensure that any individual, becoming aware of *fire*, would naturally assist others within the *firecell* to escape. The term *suite* does not apply to a group of bedrooms where each room is available to different "key-holders". In some cases a *suite* may be a single bedroom.

Surface finish The combination of a surface coating and substrate material on surfaces of *building elements* exposed to view. It can be an applied decorative coating or the uncoated *building element* itself. For interior surfaces the requirements are evaluated in terms of a *Group Number*. For exterior surfaces the requirements are evaluated in terms of rate of heat release as determined by Appendix C, Paragraph C6.1.

Travel distance The length of the *escape route* as a whole or the individual lengths of its parts, namely:

- a) *open paths* and
- b) *safe paths*.

Unprotected area In relation to an *external wall* of a *building*, this means:

- a) Any part of the *external wall* which is not *fire* rated or has less than the required *FRR*, and
- b) Any part of the *external wall* which has combustible material more than 1.0 mm thick attached or applied to its external face, whether for cladding or any other purpose.

Comment:

Unprotected area includes non-*fire* rated windows, doors, or other openings, and non-*fire* rated *external wall construction*.

Wharenui A communal meeting house having a large open floor area used for both assembly and sleeping in the traditional Maori manner.

Part 1: General

CONTENTS

- 1.1 Introduction and scope
- 1.2 Using this Acceptable Solution
- 1.3 Alterations and change of use to buildings
- 1.4 Calculating occupant loads

1.1 Introduction and scope

This Acceptable Solution can be used for establishing compliance with NZBC C1 to C6 Protection from Fire. It is one of a suite of Acceptable Solutions C/AS1 to C/AS7, each of them corresponding to a *risk group* (summarised in Table 1.1 and defined in Paragraph 1.1.1).

If the uses of a *building*, or part of a *building*, cover more than one *risk group*, one or more of these Acceptable Solutions may need to be followed to demonstrate compliance. Paragraph 1.2 explains how to determine the relevant *risk groups* for the *building* activities.

Notes shown under 'Comment', occurring throughout this document, are for guidance purposes only and do not form part of this Acceptable Solution. Words in *italic* are defined at the front of this document. For ease of use, paragraphs, tables and figures containing similar information are allocated the same reference numbers in each of the Acceptable Solutions. If there is no corresponding information in a particular Acceptable Solution, the numbering is preserved by the notation:

1) "THIS PARAGRAPH DELIBERATELY LEFT BLANK"

2) "This table not required for this Acceptable Solution"

3) Figures are omitted without notification.

Appendices to this Acceptable Solution are part of and have equal status to this Acceptable Solution.

Comment:

It is recommended that the commentary document for Acceptable Solutions C/AS1 to C/AS7 be read in conjunction with this Acceptable Solution.

Table 1.1 Risk groups and Acceptable Solutions			
	Acceptable Solution	Risk group	Applies to
C/AS1	Single household units and small multi-unit dwellings	SH	Houses, townhouses and small multi-unit dwellings
C/AS2	Sleeping (non institutional)	SM	Permanent accommodation eg, apartments Transient accommodation eg, hotels, motels, hostels, backpackers Education accommodation
C/AS3	Care or detention	SI	Institutions, hospitals (excluding special care facilities), residential care, resthomes, medical day treatment (using sedation), detention facilities (excluding prisons)
C/AS4	Public access and educational facilities	CA	Crowds, halls, recreation centres, public libraries (<2.4 m storage height), cinemas, shops, personal services (eg, dentists and doctors except as included above, beautician and hairdressing salons), schools, restaurants and cafes, early childhood centres
C/AS5	Business, commercial and low level storage	WB	Offices (including professional services such as law and accountancy practices), laboratories, workshops, manufacturing (excluding foamed plastics), factories, processing, cool stores (capable of <3.0 m storage height) and other storage buildings capable of <5.0 m storage height, light aircraft hangars
C/AS6	High level storage and other high risks	WS	Warehouses (capable of ≥5.0 m storage height), cool stores (capable of ≥3.0 m storage height), trading and bulk retail (≥3.0 m storage height)
C/AS7	Vehicle storage and parking	VP	Vehicle parking – within a building or a separate building

Comment:

Designing a *building* to provide *fire safety* involves decisions on both the *construction* materials and layout needed to reduce the risk to an acceptable level. The risk is assessed according to: the number and mobility of the occupants (*occupant load* and *risk group* of the *building*); the activities undertaken within the *building*; and the nature of the *building* materials and contents. This assessment allows each *building* activity to be categorised in a *risk group*, which is the basis for determining *fire safety* features.

Scope

1.1.1 The scope of this Acceptable Solution is restricted to *risk group CA*. This covers *buildings*, or parts of *buildings*, where people congregate, participate in group activities, or where personal services are provided. These include the following, provided they are no more than 20 storeys high (from ground level):

- a) Halls, *theatres*, cinemas
- b) *Early childhood centres*
- c) Shops and shopping malls
- d) Recreation and event centres (with tiered seating for up to 2000 people and with any primary egress for more than 100 people at the level of the playing surface)
- e) Churches and other places of worship
- f) Libraries with less than 2.4 m storage height
- g) Education institutions without sleeping, and
- h) Personal services eg, dentists and doctors (where not included in *risk group SI*), beauty therapists and hair salons.

Outside the scope of this Acceptable Solution

1.1.2 *Buildings* or parts of *buildings* in *risk groups* other than CA are outside the scope of this Acceptable Solution. Refer to Table 1.1 and use the corresponding Acceptable Solution instead.

Buildings with complex features are outside the scope of this Acceptable Solution and also of the Acceptable Solutions C/AS1 to C/AS7 corresponding to other *risk groups*. Verification Method C/VM2 shall be used instead. Complex features include:

- a) Atriums
- b) *Intermediate floors*, other than limited area *intermediate floors*
- c) Stadiums where tiered seating is provided for more than 2000 people or where the primary access for more than 100 people is above the level of the playing surface, and
- d) *Buildings* more than 20 storeys high.

Buildings that require specific *fire* engineering design (ie, those requiring design calculations and modelling) also fall outside the scope of Acceptable Solutions C/AS1 to C/AS7. If the Acceptable Solution cannot be followed in full, use Verification Method C/VM2 to demonstrate compliance.

1.1.3 THIS PARAGRAPH DELIBERATELY LEFT BLANK

1.1.4 THIS PARAGRAPH DELIBERATELY LEFT BLANK

Hazardous substances not covered by this Acceptable Solution

1.1.5 This Acceptable Solution does not provide for any use, storage or processing of *hazardous substances*. Compliance with NZBC F3 and the Hazardous Substances and New Organisms Act 1996 shall be ensured where applicable in addition to the requirements of this Acceptable Solution.

1.2 Using this Acceptable Solution

1.2.1 The process for using this Acceptable Solution shall be as follows.

Step 1: Determine which Acceptable Solutions apply

- a) Determine the *risk group* for each of the activities carried out in the *building* (refer to Table 1.1 and to Paragraph 1.1.1 of this and the other Acceptable Solutions). If the activity is not listed explicitly, choose the nearest suitable *risk group*.
- b) If there is more than one *risk group* for a *firecell*, determine its primary *risk group* (see Paragraph 1.2.2: this is the one with the most onerous *fire* safety requirements).
- c) Apply this Acceptable Solution for any *firecell* in *risk group* CA by following steps 2 and 3.
- d) Then apply the relevant Acceptable Solutions for *firecells* with any other *risk groups* in the *building*.

Comment:

Firecells: The Acceptable Solutions use the concept of *firecells* to divide *buildings* into compartments. Each *firecell* can be considered individually in the first instance and subsequently the *fire* safety requirements for the whole *building* can be developed, for example when considering a multi-storey *building* that has different activities on a number of floors, or even has different activities/uses on the same floor.

Future flexibility: A *building* is very likely to undergo one or more changes of use over its lifetime. Even under the same use, floor layout and furnishing will alter to accommodate changes in technology and occupant practices. Therefore, at the time of initial *construction*, *owners* should consider the advantages of providing for *fire* safety systems to suit alternative occupancies as these systems could be difficult or excessively expensive to install at a later date.

For Paragraph 1.2.1 Step 1 b), the most onerous *fire* safety requirements usually occur in Part 2: Firecells, *fire* safety systems and *fire* resistance ratings of each Acceptable Solution. *Buildings* or parts of *buildings* with sleeping occupancies generally have the most onerous requirements.

Step 2: Determine the parameters for risk group CA

- a) Establish the relevant *building* measurements (these will include *building height*, floor plans, wall openings and distances to *relevant boundaries*).
- b) Work out the *occupant loads* for the relevant *building spaces* (refer to Paragraph 1.4).

Comment:
Applying the Acceptable Solution depends largely on the basic *building* measurements as above. Therefore, this should be determined as accurately as possible before using this document.

Comment:
For example, levels of a multi-storey *building* may be categorised in different *risk groups* such as:

Basement carparks	VP
Shopping floors	CA
Office floors	WB
Domestic accommodation	SM

A single floor may also contain several *risk groups* such as:

Offices	WB
Shops	CA
Cafeteria	CA

Step 3: Satisfy the fire safety requirements

Satisfy the *fire* safety requirements of this Acceptable Solution (refer to Parts 2-7), based on the *occupant loads* and on the *building's* dimensions and features where required.

Primary risk groups

1.2.2 If a *building* contains a number of different activities which individually may be categorised in different *risk groups*, the *risk group* designated for a particular *firecell* within a *building* shall be that of the primary *risk group*. The primary *risk group* shall be that one within the *firecell* that has the most onerous *fire* safety requirements.

1.2.3 Depending on the particular *building* and the uses or activities within that *building*, there may be several primary *risk groups*, with one or more on each floor.

1.3 Alterations and changes of use to buildings

.....
If this Acceptable Solution is being used for an assessment of an existing *building* that is being *altered*, Parts 2, 3, 4 and 6 of this Acceptable Solution shall be considered to the extent necessary for compliance with the *Building Act* s112.

The *building work* itself shall comply fully with this Acceptable Solution.

If this Acceptable Solution is being used where an existing *building* is undergoing a change of use, all parts of this Acceptable Solution shall be considered to the extent necessary for compliance with the *Building Act*.

Where compliance with the requirements of the *Building Act* for alterations and changes of use is not fully demonstrated through using this Acceptable Solution, Verification Method C/VM2 shall be used.

Errata 1
Feb 2013

Errata 1
Feb 2013

1.4 Calculating occupant loads

Occupant load

1.4.1 The *occupant load* shall be determined from the *risk group* and number of people in each space of the *building*. The *occupant load* may need to be evaluated not only for each *risk group* but also for:

- a) A space or open floor area involving one or more activities, and
- b) A floor containing more than one *risk group*, and
- c) A single *firecell*, and
- d) Each floor within a *firecell*.

1.4.2 *Occupant loads* shall be calculated from the occupant densities given in Table 1.2 based on the floor area of the part of the *building* housing the activity (see Figure 1.1). The occupant densities in Table 1.2 already allow for a proportion of the floor area appropriate to the activity being occupied by furniture, partitions, *fixtures* (see Figure 1.1) and associated equipment. If a *building* space has alternative activity uses, the activity having the greatest occupant density shall be used. If an activity is not specifically described in Table 1.2, the nearest reasonable description shall be used.

Comment:

When using Table 1.2 to calculate the *occupant load* note that the occupant densities in Table 1.2 already allow for a proportion of the floor area appropriate to the activity being occupied by furniture, partitions, and *fixtures* and associated equipment.

1.4.3 Duplication shall be avoided by:

- a) Ensuring that, where people may be involved in more than one activity, they are counted only once, and
- b) Not including an *occupant load* for areas such as *exitways*, lift lobbies or sanitary facilities that are used intermittently by people already counted elsewhere in the *building*.

Fixed seating

1.4.4 *Occupant load* assessment shall take account of the actual arrangement and number of seats for fixed seating (see Paragraph 3.7.4). Where additional floor area abuts the fixed seating, additional occupants are permitted for based on standing space density, provided the *escape route* is not obstructed.

1.4.5 THIS PARAGRAPH DELIBERATELY LEFT BLANK

Justification for exceptions

1.4.6 If, in a particular situation, the *occupant load* derived from Table 1.2 is clearly more than that which will occur, the basis of any proposal for a lesser *occupant load* shall be substantiated to the *building consent authority*.

Comment:

This may make it possible to reduce the *occupant load* to below a trigger point for a *fire safety system* (eg, if the *occupant load* is less than 1000, no sprinkler is required).

However, note that designing a *building* for a reduced *occupant load* can severely restrict future occupancy options and may involve significant expense in meeting the *means of escape from fire* provisions for increased numbers.

1.4.7 If the maximum *occupant load* is greater than that calculated from Table 1.2, the higher number shall be used as the basis for the *fire safety design* and will need to be justified to the *building consent authority*.

Figure 1.1 Calculation of floor area of firecell
Paragraph 1.4.2

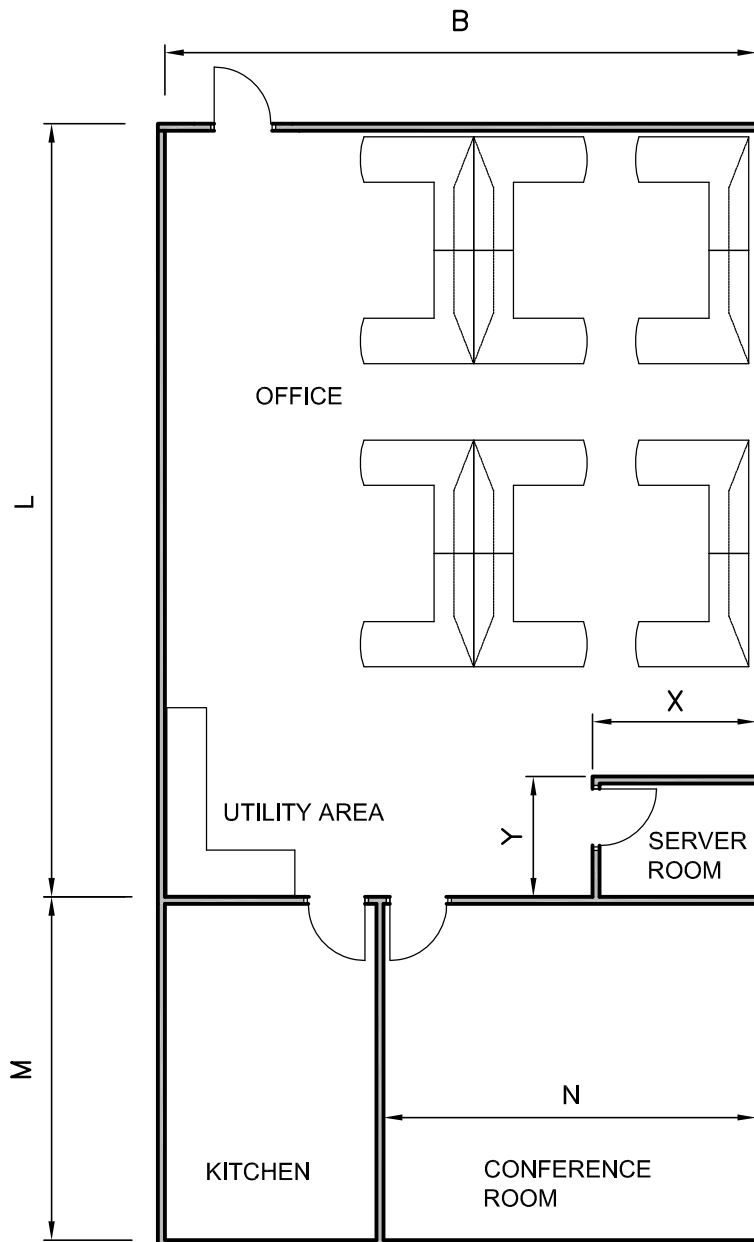

$$\text{Area of Fire Cell} = (L \times B) - (X \times Y) + (M \times N)$$

NOTE:

1. Occupant densities will be different for 'office' and 'conference room'.
2. Server room and kitchen will be intermittently occupied by the occupants of the office and this can be ignored for the purposes of calculating occupancy. However, the maximum occupancy of the kitchen is required to ensure there is sufficient exit width and number of exits from the space.

Table 1.2		Occupant densities for risk group CA	
Activity		Occupant density (m²/person)	
	Area without seating or aisles	1	
	Art galleries, museums	4	
	Bar sitting areas	1	
	Bar standing areas	0.5	
	Bleachers, pews or bench-type seating	0.45 linear m per person	
Errata 1 Feb 2013	Bulk retail (DIY building supplies, supermarkets etc)	5	
	Classrooms	2	
	Consulting rooms and personal service facilities (doctors, dentists, beauty therapy)	5	
	Dance floors	0.6	
	Day care centres	4	
	Dining, beverage and cafeteria spaces	1.25	
	<i>Early childhood centres</i>	Based on Education (Early Childhood Services) Regulations 2008 plus the number of staff	
	Exhibition areas, trade fairs	1.4	
	Fitness centres/weights rooms	5	
	Gaming, casino areas	1	
	Indoor games areas, bowling alleys	10	
	Libraries: stack areas	10	
	Libraries: other areas	7	
	Lobbies and foyers	1	
	Mall areas used for assembly uses	1	
Errata 1 Feb 2013	Office spaces	10	
	Reading or writing rooms and lounges	2	
Errata 1 Feb 2013	Reception areas	10	
	Restaurants, dining rooms and lounges	1.1	
	Shop spaces and pedestrian circulation areas including malls and arcades	3	
	Shop spaces for furniture, floor coverings, large appliances, building supplies and Manchester	10	
	Showrooms	5	
	Space with fixed seating	As number of seats	
	Space with loose seating	0.8	
	Space with loose seating and tables	1.1	
	Sports halls	3	
	Stadiums and grandstands	0.6	
	Staffrooms and lunchrooms	5	
	Stages for theatrical performances	0.8	
	Standing space	0.4	
	Swimming pools (water surface area)	5	
	Swimming pools: surrounds and seating	3	
	Teaching laboratories	5	
	Vocational training rooms in schools	10	

Part 2: Firecells, fire safety systems and fire resistance ratings

CONTENTS

- 2.1 Provision of firecells
- 2.2 Fire safety systems
- 2.3 Fire resistance ratings

2.1 Provision of firecells

Firecell floor area limits

2.1.1 The floor area of an unsprinklered *firecell* shall not exceed 5000 m².

2.1.2 If a *firecell* is sprinklered, the *firecell* floor area may be unlimited, except if specified otherwise in this Acceptable Solution when *building* areas require subdivision or other area limitations are imposed.

2.1.3 THIS PARAGRAPH DELIBERATELY LEFT BLANK

2.2 Fire safety systems

2.2.1 The *fire safety systems* for *firecells* required for this *risk group* shall be as follows. *Fire safety system* types shall be as defined in Table 2.1.

For <100 people and <4.0 m escape height

- a) Type 2 alarm system. A direct connection to the Fire Service is not required if a phone is available at all times for emergency calls. This system is not required if the *escape routes* serve no more than 50 people in a single-level *building*, and
- b) Type 18 *building fire* hydrant system, unless the Fire Service hose run distance from the point of Fire Service vehicular access to any point on any floor is less than 75 m.

For 100 to 1000 people or 4.0 m to 25 m escape height

- a) Type 4 alarm system. A direct connection to the Fire Service is not required if:
 - i) there are less than 200 people, and
 - ii) the escape height is 0 m, and
 - iii) a phone is available at all times for emergency calls, and
- b) Type 9 smoke control in air handling systems, and
- c) Type 18 *building fire* hydrant system, unless the Fire Service hose run distance from the point of Fire Service vehicular access to any point on any floor is less than 75 m. However, a *building fire* hydrant system is required in all cases if the *building* is four storeys or higher.

Errata 1
Feb 2013

For >25 m escape height or >1000 people

- a) Type 7 sprinkler and alarm system, and
- b) Type 9 smoke control in air handling systems, and
- c) Type 18 *building fire* hydrant system.

Special requirements for early childhood centres

2.2.2 In addition to Paragraph 2.2.1, the *fire safety systems* required for *firecells* in *early childhood centres* shall be as follows.

- a) In single storey *early childhood centres*, dedicated sleeping areas shall be protected with supplementary smoke detectors. The alarm system and any smoke detection system shall comply with NZS 4512.
- b) Where the *escape height* is greater than 2.0 m, a Type 7 alarm system shall be installed throughout the *building*.

Comment:

Intermediate floors that children are unable to access do not need to be included in the *escape height*.

The *escape height* limitation of 2.0 m is used to allow *early childhood centres* that may be slightly above or below the actual ground floor to be treated as being on the ground floor – for example on a sloping site where there may be a small set of stairs up or down to the centre.

2.2.3 If any *firecell* in a *building* requires a manual or automatic *fire* alarm or sprinkler system, that system shall be provided in all other *firecells* throughout the *building* (refer to Figure 2.1). As a Type 5 system (refer to Table 2.1) provides for non-latching smoke detection with heat detection back-up in sleeping spaces, other (non-sleeping) *firecells* shall be protected with standard automatic smoke detection. Where sleeping spaces are provided in the other *firecells* they shall be protected with a Type 5 system where a Type 4 is being extended. Smoke detection shall not be extended into *risk group* VP: heat detection shall be provided instead.

Errata 1
Feb 2013

More than one risk group on a floor

2.2.4 If there is more than one *risk group* on one floor level, the *fire* safety requirements will depend on whether the *risk groups* occupy the same *firecell*, or whether the floor is divided by *fire separations* into different *firecells*.

Comment:

Refer to Paragraphs 2.2.1 to 2.2.3 for the requirements for individual *firecells* in this *risk group*.

2.2.5 Where *fire separations* are not needed between different *risk groups* on the same floor level, the *fire* safety systems adopted for the whole floor level shall be those of the primary *risk group* (as defined in Paragraph 1.2.2).

Table 2.1 Fire safety systems specified in this Acceptable Solution		
Type of system	System description	Relevant Standards for installation
1	Domestic smoke alarm	Acceptable Solution F7/AS1
2	Alarm system with manual call points	NZS 4512
3	Heat detection system with manual call points	NZS 4512
4	Smoke detection and alarm system with manual call points	NZS 4512
5	Enhanced smoke detection and alarm system with manual call points	NZS 4512
6	Automatic <i>fire</i> sprinkler system	NZS 4541
7	Automatic <i>fire</i> sprinkler system with smoke detection and alarm system	NZS 4541, NZS 4512
9	Smoke control in air handling system	AS/NZS 1668.1
18	<i>Building fire</i> hydrant system	NZS 4510

Figure 2.1 Systems throughout a building
Paragraph 2.2.3

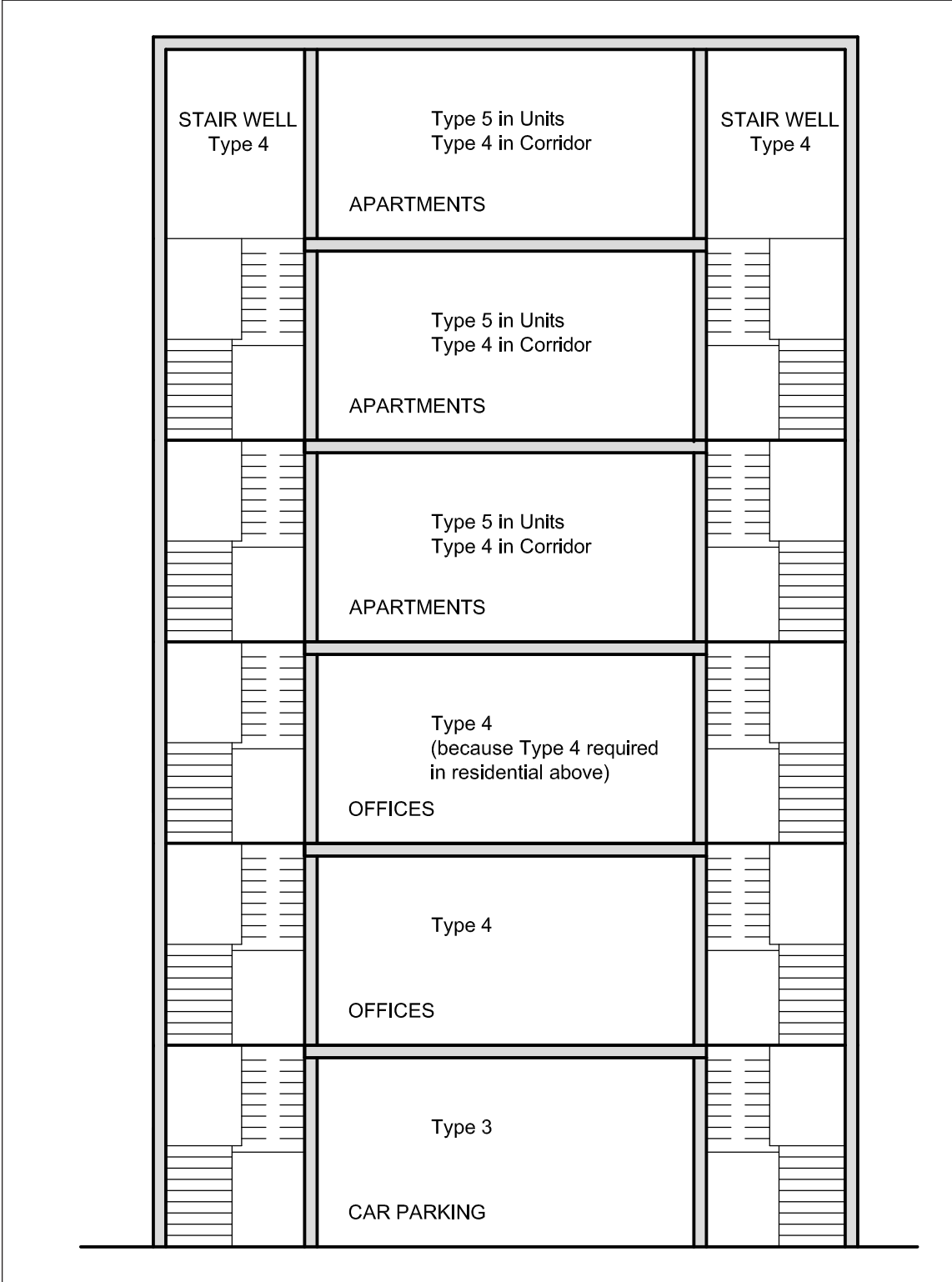

2.2.6 The *fire safety systems* required by Paragraph 2.2.3 shall be interconnected to alert all occupants of that floor level in the event of *fire*.

Comment:

Refer to Paragraphs 2.2.7 and 2.2.8 for the requirements for other floor levels in the *building*.

Other floors in a building

2.2.7 The alarm systems required in a *building* shall be interconnected to alert all *building* occupants in the event of *fire*, except:

- a) In areas that have the local smoke component of a Type 5 system.
- b) DELIBERATELY LEFT BLANK

Same risk group on different floors

2.2.8 Where *firecells* containing the same *risk group* occur at different levels in the same *building*, the *fire safety systems* for the *firecell* having the greatest *escape height* shall be applied to all *firecells* in that *risk group*.

2.2.9 THIS PARAGRAPH DELIBERATELY LEFT BLANK

2.2.10 THIS PARAGRAPH DELIBERATELY LEFT BLANK

2.3 Fire resistance ratings

FRR values

2.3.1 Unless explicitly stated otherwise in this Acceptable Solution, the *fire resistance ratings (FRRs)* that apply for this *risk group* shall be as follows:

Life rating = 60 minutes. This applies to *fire rating* requirements in Part 3: Means of escape and Part 4: Control of internal fire and smoke spread.

Property rating = 120 minutes. This applies to *fire rating* requirements in Part 5: Control of external fire spread.

Comment:

Throughout this Acceptable Solution, minimum *FRRs* are specified for particular situations. It is therefore essential to check for specific requirements.

2.3.2 If a fire sprinkler system is provided, the *FRRs* for *risk group CA* shall be:

Life rating = 30 minutes, and
Property rating = 60 minutes.

2.3.3 If there is more than one *risk group* on one floor in the *building*, the highest required *FRR* shall be applied to common spaces and shared *escape routes* for that floor level.

General requirements for FRRs

2.3.4 *FRRs* shall apply to the sides of *primary* and *secondary elements* which are exposed to *fire*.

2.3.5 When different *FRRs* apply on each side of a *fire separation*, being a wall, the higher rating shall apply to both sides.

2.3.6 Floors shall have an *FRR* for exposure from the underside.

2.3.7 The *FRR* of a *primary element* integral with a *fire separation* shall be no less than that of the *fire separation*.

2.3.8 Except as required by Paragraph 4.3.3, areas of *external wall* not permitted to be *unprotected areas* shall be rated for *fire* exposure from within a *firecell*.

2.3.9 Areas of *external wall* not permitted to be *unprotected areas* shall be rated for *fire* exposure from both sides equally where:

- a) Walls are within 1.0 m of the *relevant boundary*, or
- b) The *building height* is more than 10 m.
- c) DELIBERATELY LEFT BLANK

2.3.10 THIS PARAGRAPH DELIBERATELY LEFT BLANK

2.3.11 Structural framing members connected to *building elements* with an *FRR* shall be rated at no less than the elements to which they are connected, or alternatively their connections and supports shall be designed so that their collapse during *fire* will not cause collapse of the *fire* rated elements.

Applying insulation component in FRR

2.3.12 *Insulation* ratings shall apply to:

- a) All *fire separations*, except as noted in Paragraph 2.3.13
- b) Parts of *external walls* that are not permitted to be *unprotected areas*, and
- c) Parts of *external walls* which are within 2.0 m of an external *exitway* where it is a single *means of escape from fire* (see Paragraph 3.11.2).

2.3.13 *Insulation* ratings are not required to apply to:

- a) Glazing installed in accordance with Paragraph 4.2, or
- b) Where sprinklers are installed throughout the *building*, in accordance with either NZS 4541 or NZS 4515 as appropriate.

Part 3: Means of escape

CONTENTS

- 3.1 General principles
- 3.2 Number of escape routes
- 3.3 Height and width of escape routes
- 3.4 Length of escape routes
- 3.5 Escape from basements
- 3.6 Open paths
- 3.7 Special cases of open paths
- 3.8 Dead ends
- 3.9 Exitways
- 3.10 Control of exitway activities
- 3.11 External escape routes
- 3.12 Final exits
- 3.13 Single escape routes
- 3.14 Deliberately left blank
- 3.15 Doors subdividing escape routes
- 3.16 Signs

3.1 General principles

3.1.1 All *buildings* shall have *means of escape from fire* which include *escape routes*. An *escape route* (see Figure 3.1) shall provide protection to any occupant escaping to a *safe place* from a *fire* within a *building*.

3.1.2 The components of an *escape route*, in ascending order of protection, are the *open paths*, *exitways* (these may comprise *smoke lobbies* and *safe paths*), and *final exits* (see Figure 3.1). Two or more of these components will be necessary, depending on the total *travel distance*. An *escape route* shall not pass from a higher to lower level of protection in the direction of escape.

3.1.3 Provided the allowable lengths of *open paths* are not exceeded, an *escape route* may comprise only an *open path* and *final exit*.

3.1.4 *Escape routes* shall comply with NZBC D1. Ramps, stairs, ladders, landings, *handrails*, doors, vision panels and openings shall comply with Acceptable Solution D1/AS1.

Figure 3.1 Escape routes
Paragraphs 3.1.1 and 3.1.2

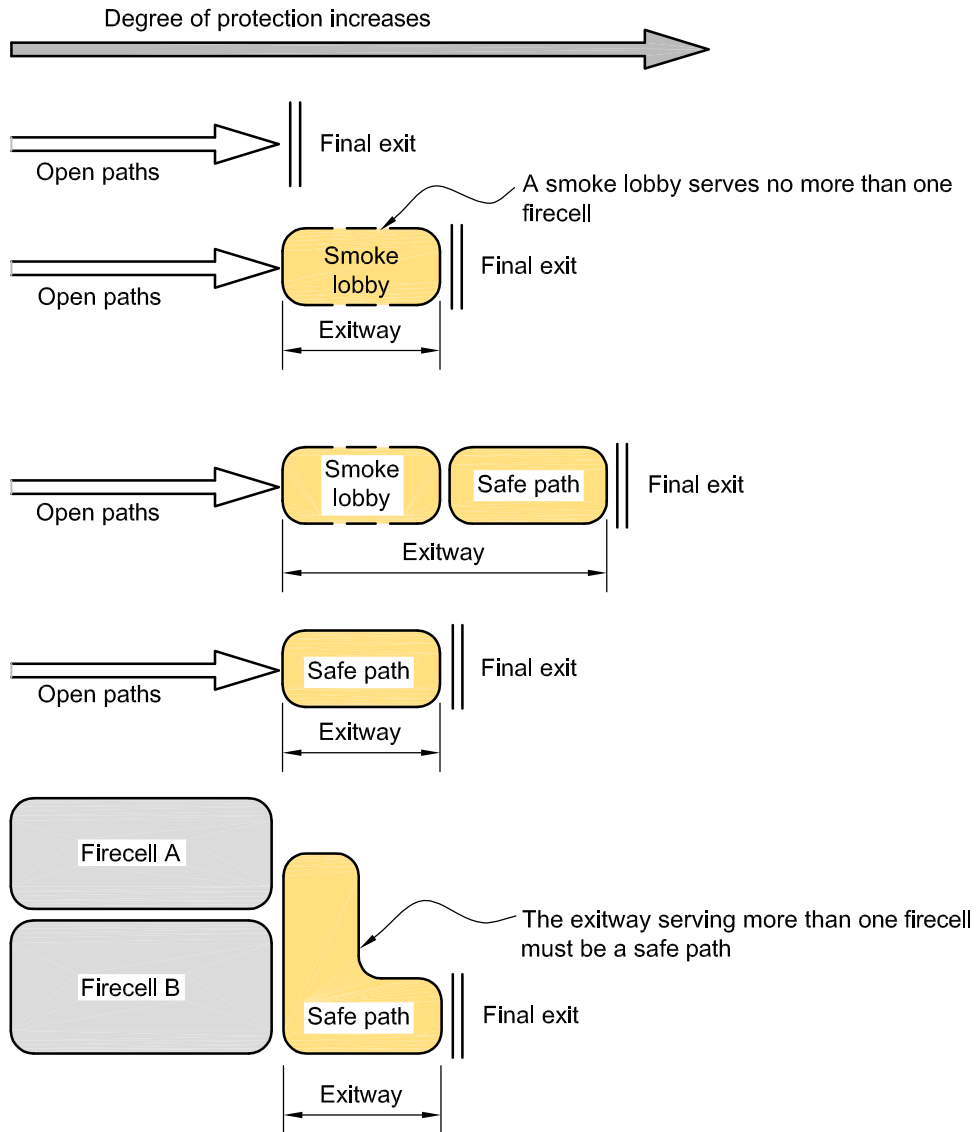

Note:

The *final exit* is where the *escape route* enters a *safe place*. This might be beyond the exit door from the *building*

3.2 Number of escape routes

3.2.1 Except where Paragraph 3.13 allows the use of single *escape routes*, every *occupied space* in a *building* shall be served by two or more *escape routes* (see Figure 3.2).

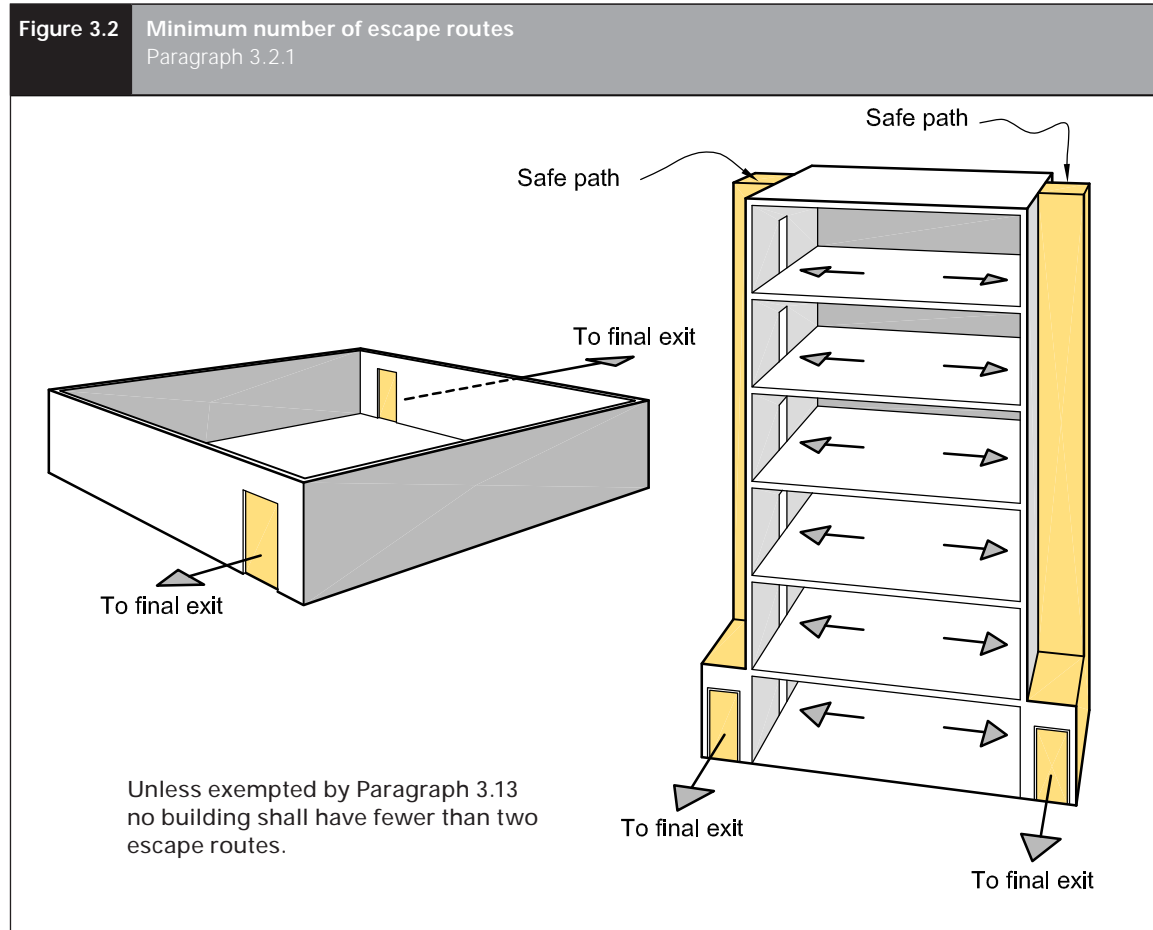

3.2.2 The minimum number of *escape routes* from a floor level, except in those situations where single *escape routes* are permitted (see Paragraph 3.13), shall be as specified in Table 3.1.

Number of occupants	Minimum number of <i>escape routes</i>
Up to 500	2
501 to 1000	3
1001 to 2000	4
2001 to 4000	5
4001 to 7000	6

3.3 Height and width of escape routes

Height

3.3.1 Height requirements within *escape routes* shall be as follows:

- The clear height shall be no less than 2100 mm across the full width, except that isolated ceiling fittings not exceeding 200 mm in diameter may project downwards to reduce this clearance by no more than 100 mm, and
- Any door opening within, or giving access to, any *escape route* shall have a clear height of no less than 1955 mm for the required width of the opening.

Width

3.3.2 Width requirements within *escape routes* shall be as follows:

- a) **Width of all available escape routes:** the total combined width of all available *escape routes* shall allow 7 mm/person for horizontal travel and 9 mm/person for vertical travel.
- b) **Not an accessible route:** if the *escape route* is not an *accessible route*, it shall have a minimum width of 850 mm for horizontal travel and 1000 mm for vertical travel, except in the following cases:
 - i) if an *escape route* is within an *exitway*, its width shall be no less than 1000 mm, and
 - ii) if there is no requirement for *people with disabilities*, the *occupant load* is less than 50 and the *escape route* is within an *open path*, its width may be reduced to 700 mm for horizontal travel and 850 mm for vertical travel.
- c) **Accessible route:** if the *escape route* is an *accessible route*, it shall have a minimum width of 1200 mm for both horizontal and vertical travel.

- d) **Provision for unusable escape routes:** except where *dead ends* and single *escape routes* are permitted, the total required width in unsprinklered *firecells* shall still be available should the widest of the *escape routes* be unusable due to the location of the *fire* or any other reason (see Figure 3.3).

Comment:

Requirement d) may be achieved either by providing additional *escape routes* or by making the minimum required number wider.

- e) **Sprinkler concession:** if the *firecell* is sprinklered, requirement d) does not apply (ie, it is not necessary to provide extra width to allow for the possibility that one *escape route* may be unusable).
- f) **Horizontal escape route with a single direction of escape:** this shall be wide enough at any point to take the full *occupant load* from all contributing *occupied spaces*. However, the *escape route* may have its width increased progressively as it passes the exit from each *occupied space* (see Figure 3.4).

Figure 3.3 Exitway widths in unsprinklered firecells
Paragraph 3.3.2 d)

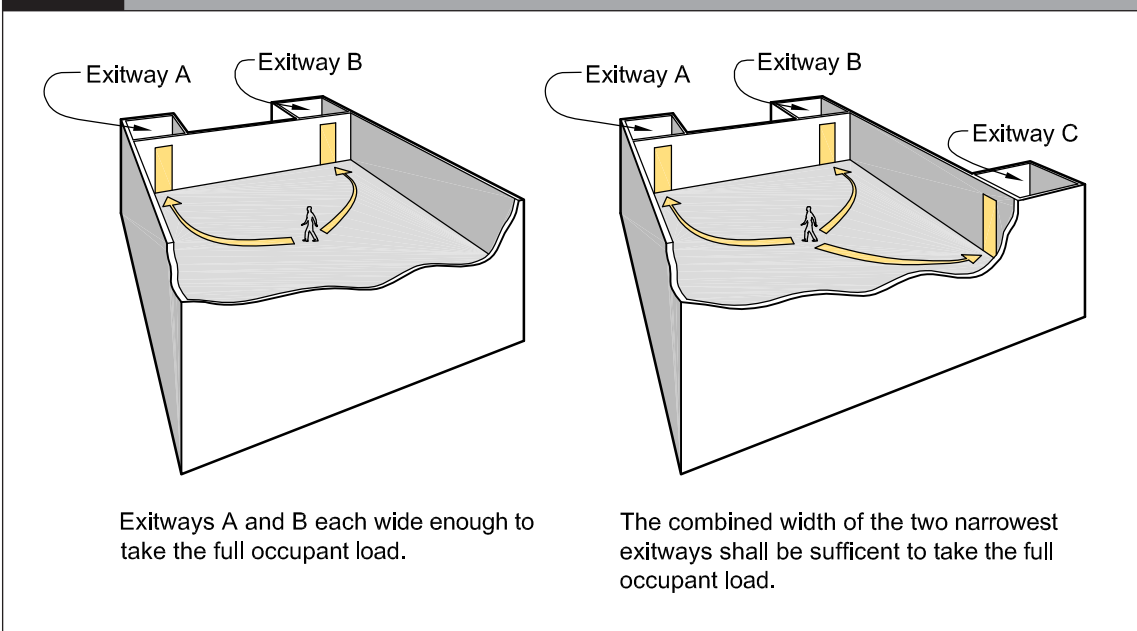

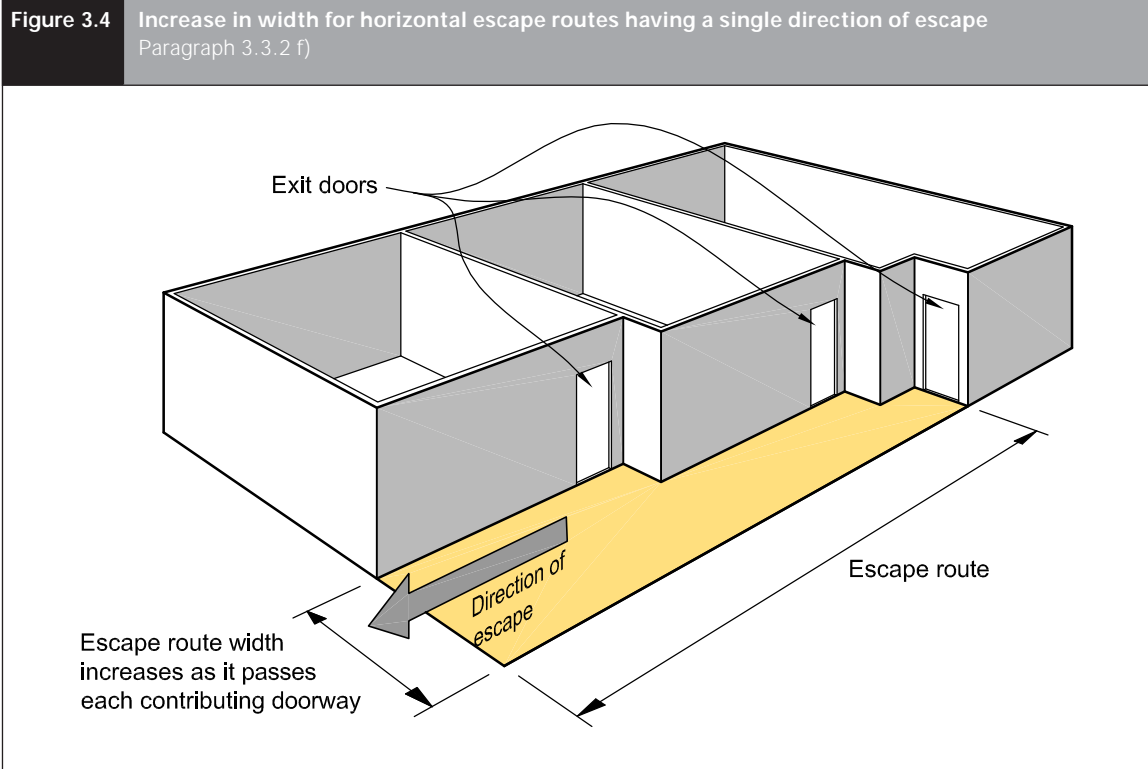

- g) **Horizontal escape route with two directions of escape:** this shall have sufficient width for the full length of the route to allow for the *occupant load* from all contributing *occupied spaces*. However, this shall not apply if the requirements of Paragraph 3.7.13 e) are met for escape through adjacent *firecells*.
- h) **Intermediate floors:** for *firecells* containing an *intermediate floor*, both the vertical and horizontal parts of the *open path escape route* shall be wide enough to take the full *occupant load* from all contributing *occupied spaces*.
- i) **Vertical safe paths serving firecells at more than one level:** these shall have minimum widths at any point determined only by the largest total *occupant load* from any level passing that point in the direction of escape.
- j) **Marae buildings using traditional Māori construction materials:** where applying the exception permitted in Paragraph 4.17.6 i), the *escape route* widths required by Paragraph 3.3.2 b) shall be doubled.
- k) **Basements:** if an *escape route* from upper floors is joined at the level of a *final exit* by an *escape route* from a *basement* or lower floors, the *escape route* width at the point they combine shall be increased to accommodate the *occupant loads* from both directions (see Figure 3.5).
- l) **Ladders:** the width requirements of Paragraph 3.3.2 b) do not apply to ladders where their use is permitted in this Acceptable Solution.
- m) **Fixed or loose seating:** the width requirements of Paragraph 3.3.2 a) to d) do not apply to fixed or loose seating.

Comment:

In vertical *safe paths* it is not necessary to provide for cumulative *occupant load* as the *escape route* passes each floor level.

Figure 3.5 Escape routes from lower and upper floors
Paragraph 3.3.2 k)

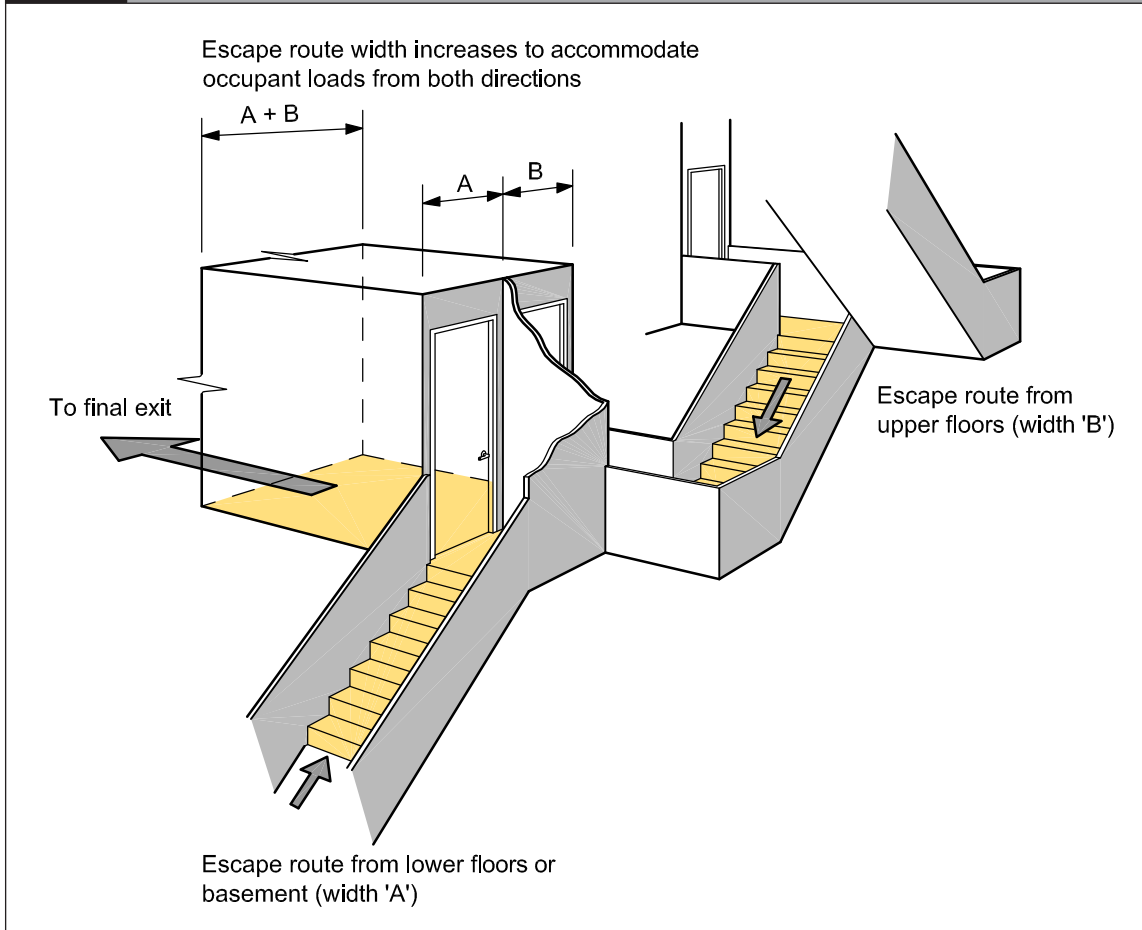

Handrails and limitations to stairway widths

3.3.3 For safe evacuation on stairs, all stairways shall have at least one *handrail*. Furthermore:

- a) Stairways in escape routes wider than 1500 mm shall have *handrails* on both sides, and
- b) Stairways in escape routes wider than 2000 mm (see Figure 3.6) shall also be provided with intermediate *handrails* which are equally spaced and which provide a width not greater than 1500 mm for each section of the *stairway*.

Comment:

Acceptable Solution D1/AS1 requires all *stairways* to have at least one *handrail*, and also requires *accessible* stairs to have *handrails* on both sides.

3.3.4 If the *escape height* exceeds 35 m, no more than 1500 mm shall be credited to the width of any *stairway* when calculating *stairway* capacity for an *escape route*.

Comment:

While the *stairway* may be wider than 1500 mm, this is the maximum width that can be used for calculating *stairway* capacity. You may need to provide additional *exitways* to carry the *occupant load*.

Figure 3.6 Limitations to stairway widths
Paragraph 3.3.3 b)

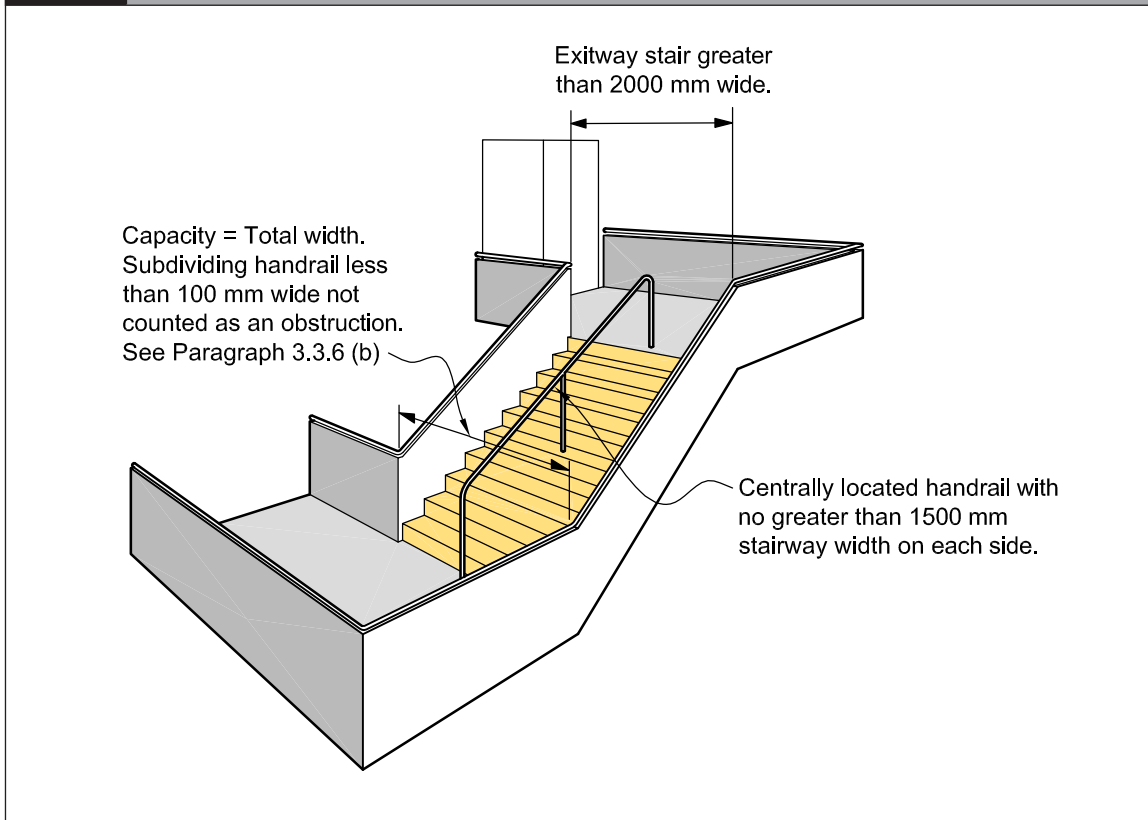

Curved and spiral stairs

3.3.5 If curved or spiral stairs form part of an *escape route*, the required width shall be that described as 'walking area' in Acceptable Solution D1/AS1.

Obstructions

3.3.6 Except as permitted by Paragraph 3.15.7, *escape routes* shall not be obstructed by access control systems such as revolving or automatic sliding doors, chains, turnstiles, sliding bars, crowd control barriers or similar devices.

The following minor obstructions are acceptable within the width of an *escape route*:

a) **Minor projections** complying with the requirements of Acceptable Solution D1/AS1 such as signs, switches, alarm sounders and similar projections

b) **Handrails** complying with Acceptable Solution D1/AS1 and projecting no more than 100 mm into the width, and *handrails* subdividing wide *stairways* that reduce the width by no more than 100 mm (see Paragraph 3.3.3)

c) **Fixed seating** (at the start of an *escape route*) which complies with the requirements of Paragraph 3.7.4 and Table 3.3 for the width of aisles and space between rows, and

d) **Door assemblies** which reduce the width of an *exitway* by no more than 125 mm when the door is fully open (see Figure 3.22).

Comment:

The 125 mm obstruction allows for projecting parts of the door frame assembly, the thickness of the door when open and similar acceptable obstructions.

3.4 Length of escape routes

3.4.1 An *escape route* may be any length, but:

- a) The lengths of *dead ends* and total *open paths* shall not exceed the distances given in Table 3.2, adjusted as necessary for:
 - i) reductions on *intermediate floors* (see Paragraph 3.4.3), and
 - ii) reductions on stairs and ladders (see Paragraph 3.4.4), and
- b) If the distance to the *final exit* exceeds the allowable length for total *open paths*, the remainder of the *escape route* shall be a *safe path* (see Paragraph 3.9.7 for *safe path* length restrictions within a single floor level).

Open paths

3.4.2 When determining *open path* lengths, including any *dead end*, the following shall apply:

- a) **Start point:** the length shall be measured from no more than 1.0 m from the most remote point in a space.
- b) **Multiple risk groups:** the lengths specified in Table 3.2 apply to *risk group CA*. When other *risk groups* with different allowable maximum *open path* lengths use the same *open path*, the *risk group* with the shortest maximum length shall apply.

- c) **Furniture and fittings:** allowance shall be made for the *travel distance* around obstructions such as furniture, fittings and office equipment located in the *open path* (see Figure 3.7 (a)). If the location of such obstructions is not known, the allowable *travel distance* shall be taken as the length plus the width of the space (see Figure 3.7 (b)).
- d) **Multiple escape routes:** if two or more *escape routes* are required, *open path* lengths from any point on a floor to no fewer than two exits from the *firecell* shall not exceed the lengths specified in Table 3.2.
- e) **Marae buildings using traditional Māori construction materials:** when applying the exception permitted in Paragraph 4.17.6 i), the permitted length of the *open path* specified in Table 3.2 shall be halved, and
- f) **Termination:** an *open path* ends either at:
 - i) the start of an *exitway*, or
 - ii) a *final exit*, or
 - iii) the point where the *escape route* passes into an adjacent *firecell* on the same level (see Paragraph 3.7.13).

Table 3.2 Travel distances on escape routes for risk group CA

	No system and Type 2 system	Type 4 system	Type 6 system	Type 7 system
<i>Dead end open path</i>	20 m	40 m	40 m	50 m
<i>Total open path</i>	50 m	100 m	100 m	120 m

If *open path* length increases for smoke detectors are being applied, where Acceptable Solution F7/AS1 allows heat detectors to be substituted for smoke detectors, not less than 70% of the *firecell* shall be protected with smoke detectors. Heat detectors cannot be substituted for smoke detectors in *exitways*.

Figure 3.7 Length of open paths
Paragraph 3.4.2 c)

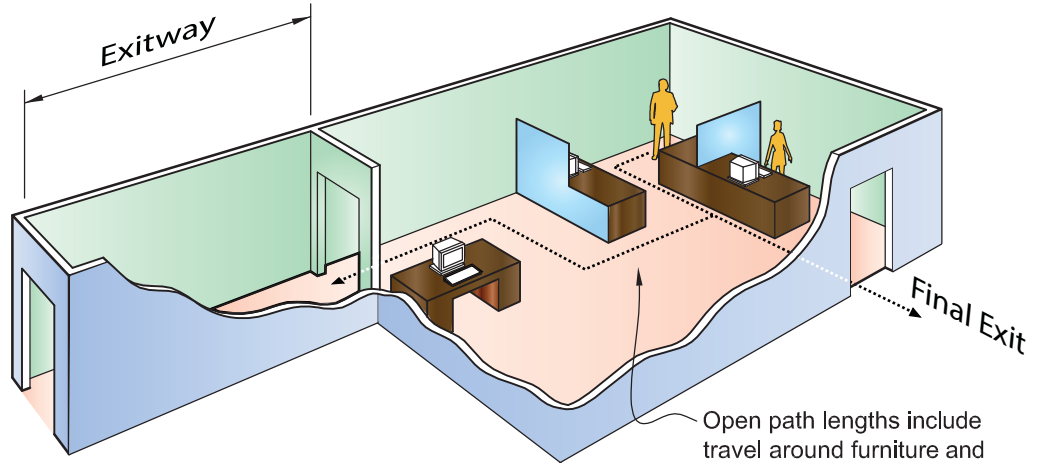

Each person shall have at least two escape routes available unless exempted by Paragraph 3.4

(a) FIXTURE AND FITTING POSITIONS KNOWN

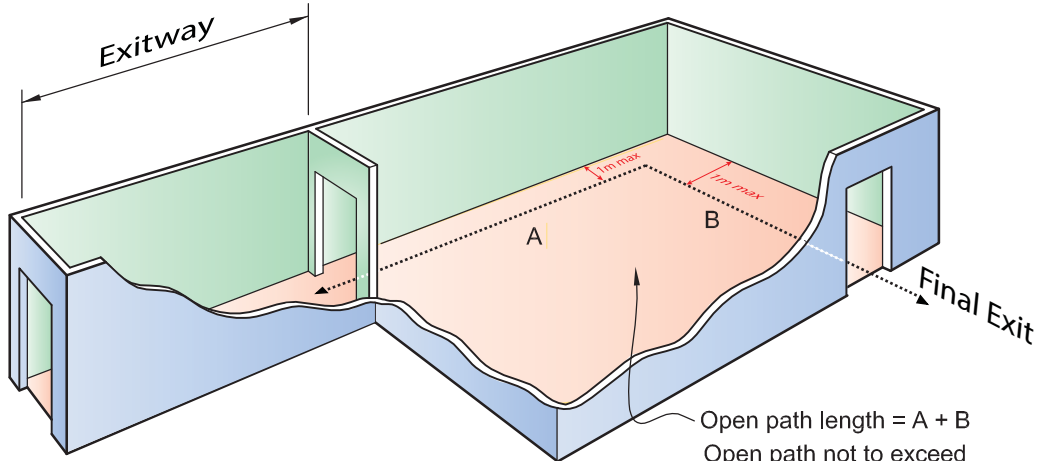

(b) FIXTURE AND FITTING POSITIONS UNKNOWN

Errata 1
Feb 2013

Intermediate floors

3.4.3 On *intermediate floors* (see Figure 3.8) the *open path* length, for compliance with Table 3.2, shall be taken as 1.5 times the measured length. However, the length as measured in accordance with Paragraph 3.4.2 c) may be used if the *intermediate floor* is a *smokecell* and an *escape route* is available from the *intermediate floor* without passing through any lower space in the same *firecell*.

Comment:

People on an *intermediate floor* may be exposed to smoke at an earlier stage than people on a full floor. Reduced *open path travel distances* mean reduced exposure time to smoke from the *fire*.

Stairs and ladders

3.4.4 Stairs and ladders occurring in an *open path* (see Figure 3.9) shall have their *open path* length taken as:

- a) **For straight and curved stairs:** the plan length measured on the stair centreline multiplied by 1.2, plus the plan length of each landing
- b) **For spiral stairs:** twice the vertical height, and
- c) **For ladders:** three times the vertical height.

Comment:

It is acceptable to use two spiral stairs as part of the *escape routes* from such situations as an *intermediate floor* down to the *firecell* floor. Likewise, where ladders are permitted to serve such situations as the fly-tower of a *theatre*, two ladders may be used as the *escape routes*.

Figure 3.8 Intermediate floor open path length
Paragraph 3.4.3

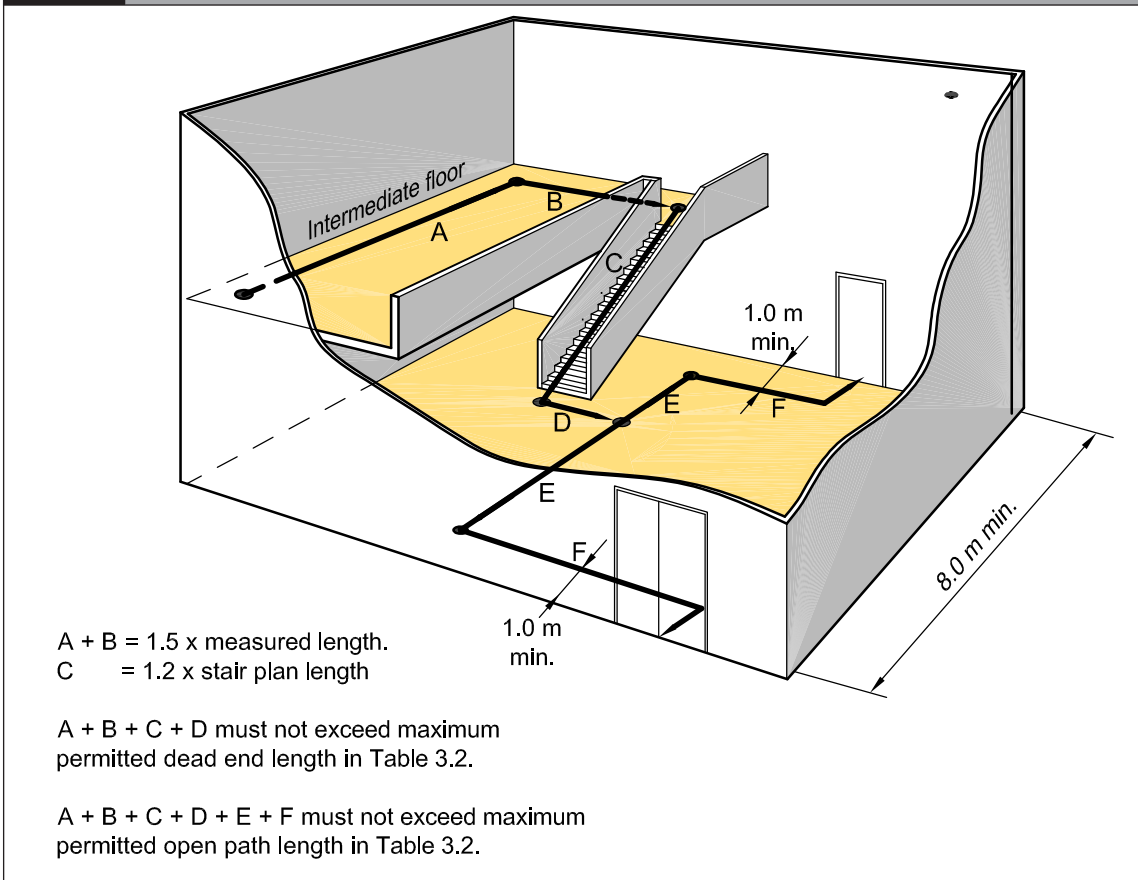

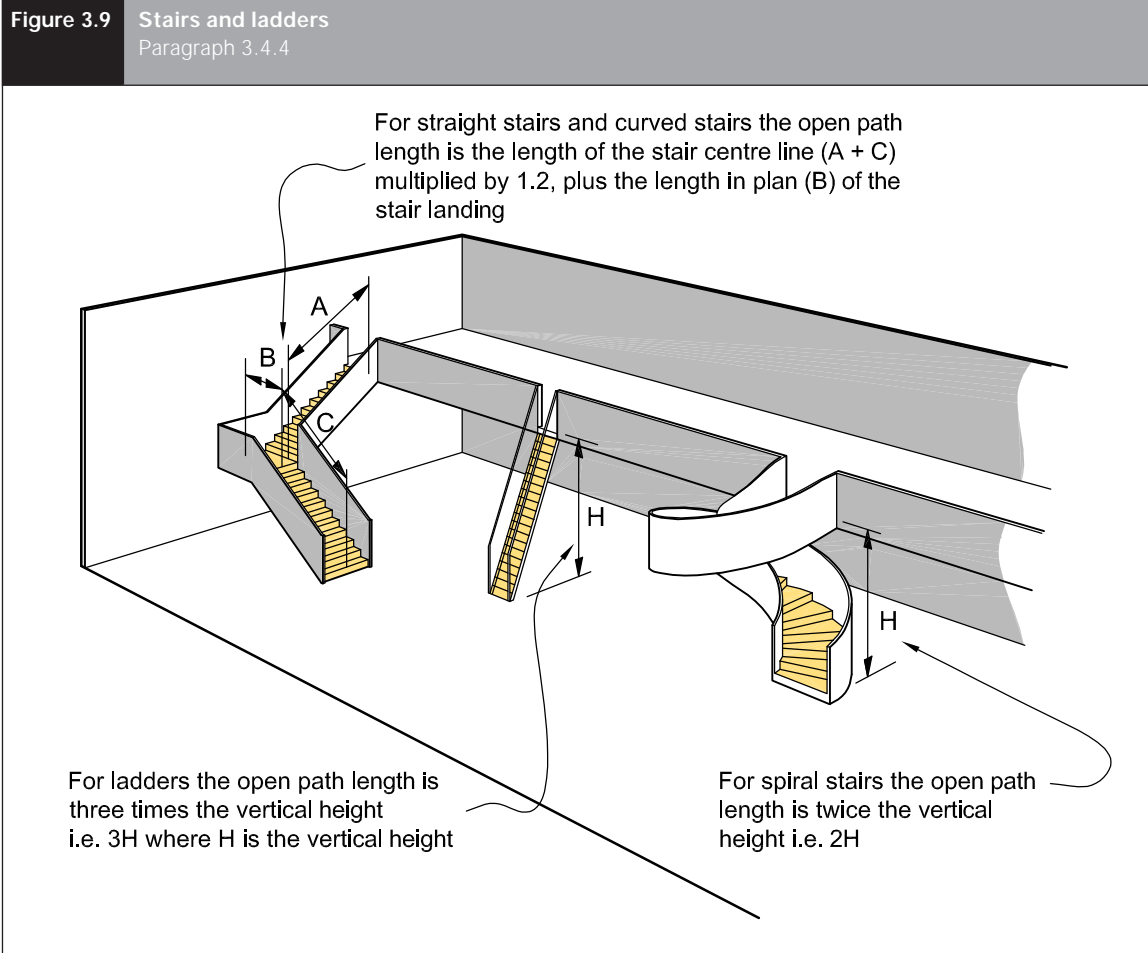

Sloping floors and ceilings

3.4.5 The *open path* length permitted by Table 3.2 shall be reduced by 50% in any space where the following conditions apply:

- Both the floor and the ceiling slope in the same direction at an angle of more than 4° from the horizontal, and any *escape route* from the space is up the slope, and
- The clear ceiling height at any point is less than 4.0 m, and
- The *occupant load* in the space is more than 50, and
- The space is unsprinklered.

Comment:

People in a space with a sloping floor and ceiling will be exposed to smoke at an earlier stage than people in a space with a flat ceiling. This can create a problem when the direction of escape is up the slope. Reduced *travel distances* mean reduced exposure time to the smoke from the *fire*.

Escape through adjoining building

3.4.6 An escape route may be via an adjoining building (see Figure 3.10), provided the following conditions are satisfied:

a) The escape route through the adjoining building meets all escape route requirements for the occupant load from the fire affected building requiring to use that route, and

Comment:

It is not necessary for the escape route to be wide enough to carry the combined occupant load from both buildings.

b) Unless the escape route passes directly to a safe path in the adjoining building, access shall be through a smoke lobby before passing through the external walls, and

c) The opening through the external wall having the higher FRR has a fire door with an FRR of no less than that wall, and

d) escape routes in the adjoining building comply with the Building Code and have sufficient capacity to carry the occupant load from the building or buildings being evacuated, and

e) The escape route does not re-enter the first building at any point, and is freely available at all times.

Figure 3.10 Escape through adjoining building
Paragraphs 3.4.6 and 4.16.9

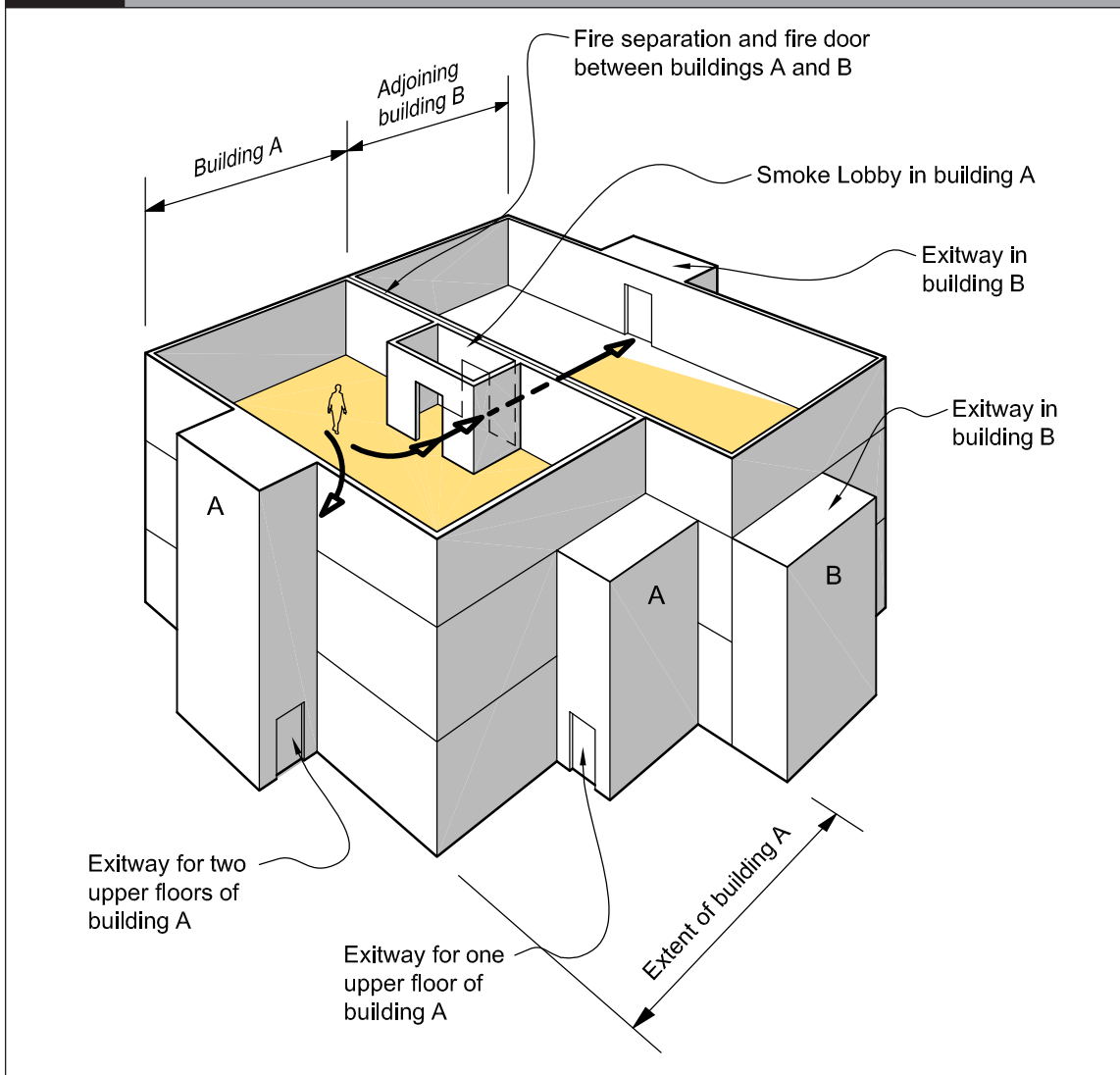

Comment:

An *escape route* of this type depends on a permanently-binding legal agreement between different *owners*, *tenants* or *occupiers*.

If the *escape routes* in the adjoining *building* comply with this Acceptable Solution, they shall have sufficient capacity to provide for the maximum number of occupants in any *firecell*. Clearly, the *escape routes* must be sized for the largest number using them in either *building* but not both. This situation should present no great problem when the adjoining *building* is, and will remain, under the same *ownership* or management control as the original *building*. However, problems may arise when the *ownership*, management, or use of the adjoining *building* changes. This can and does happen, particularly when the adjoining *building* is an existing *building* or part of it is sold under an arrangement such as the Unit Titles Act. In such cases, approval should be dependent on the provision of a legal agreement and perhaps a caveat on the title. This ensures that the dependence on the *means of escape from fire* will not be affected by subsequent events.

3.5 Escape from basements

3.5.1 Except in cases where there are two or more *escape routes* serving only the *basement firecells* and each terminates in a *safe place*, *safe paths* serving *basement firecells* shall be preceded by a *smoke lobby* that shall have a plan area in accordance with Paragraph 3.9.2.

Single escape routes

3.5.2 A single *escape route* and *final exit* is acceptable from *basements* (see Figure 3.11) where, in addition to the requirements of Paragraph 3.13.1 and the *smoke lobby* requirements of Paragraph 3.5.1, there are no more than two *basement floor levels*.

Figure 3.11 Single escape route from basement levels
Paragraphs 3.5.2 and 3.13.1 f)

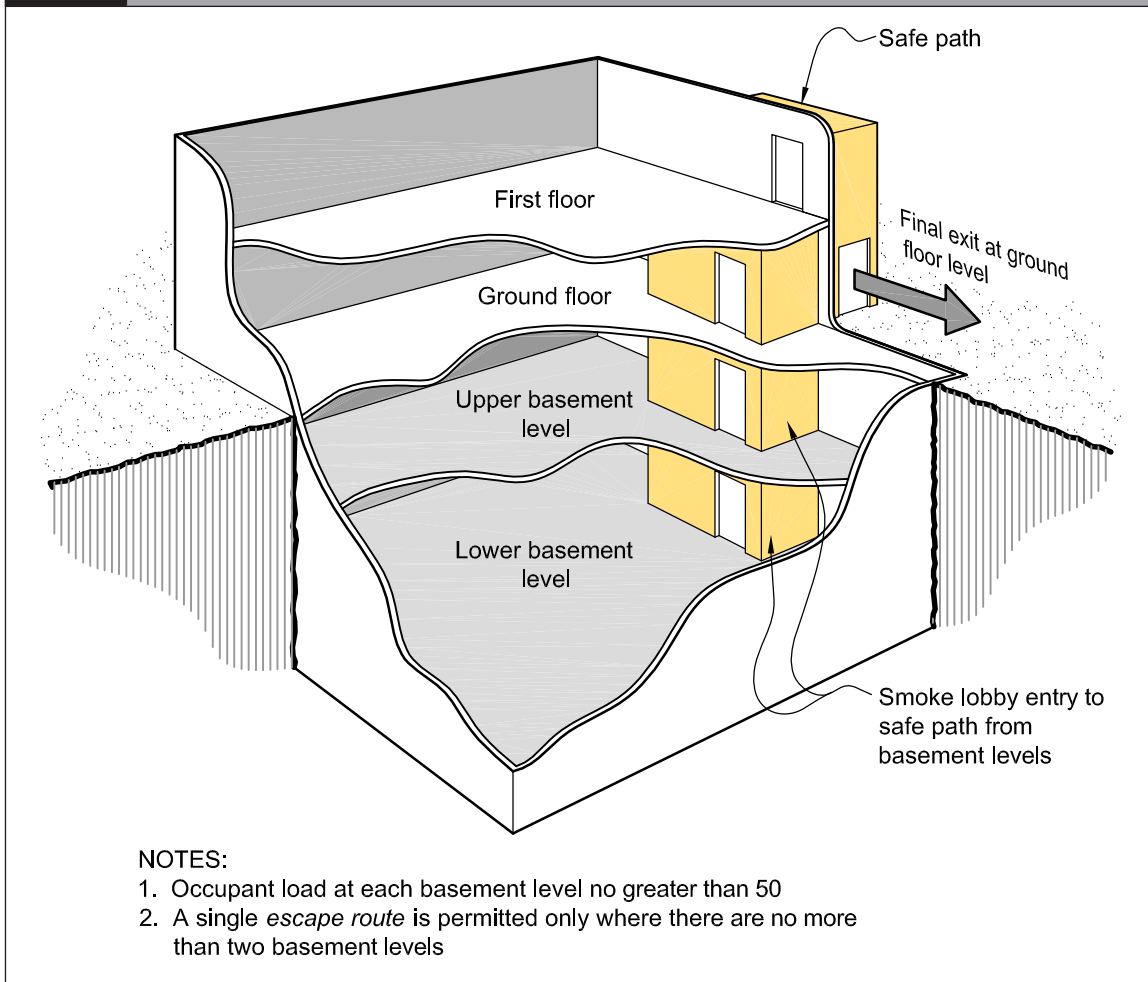

Exception for education buildings

3.6.3 If a *building* houses classrooms, laboratories and/or spaces used for home economics, art and crafts, workshops or similar teaching activities, one *open path* may be via a connecting corridor and the alternative *open path* may be via connecting doors between adjacent teaching spaces. In such cases, the separation requirements of Paragraph 3.6.2 need not apply provided that:

- a) The number of occupants in each teaching space does not exceed 100, and
- b) The *escape route* does not pass through a space which may be locked.

3.7 Special cases of open paths

Ramps

3.7.1 Where stairs are not used, changes in level on an *escape route* shall be formed as ramps and shall comply with Acceptable Solution D1/AS1.

Separate tenancy

3.7.2 *Open paths* shall only pass through spaces containing different tenancies if doors leading to an *exitway* or *final exit* can be readily opened by all persons for whom the *open path* is their *escape route*.

3.7.3 THIS PARAGRAPH DELIBERATELY LEFT BLANK

Fixed seating

3.7.4 Fixed seating, which includes seating that is moveable or foldaway, shall be arranged so that:

- a) Direct access to the aisles is available
- b) The number of seats in a row is no greater than that specified in Table 3.3
- c) The clear walkway width between rows is no less than that specified in Table 3.3, and

The area occupied by each seat plus the walkway in front of it has a total dimension of at least 760 mm from seat back to seat back measured horizontally at right angles to the rows of seats (see Figure 3.13).

The seat width must be at least:

- i) 500 mm where arms are provided (see Figure 3.13), and
- ii) 450 mm where arms are not provided.

Minimum walkway width (mm)	Maximum number of seats in any row	
	One aisle	Aisles both sides
300	7	14
340	9	16
380	9	18
420	10	20
460	11	22
500	12	24

Aisles

3.7.5 Aisles serving fixed or loose seating (see Figure 3.14) shall provide access to *final exits* or *escape routes*. The width of the *final exits* or *escape routes* shall be the greater of the:

- a) Aisle width as required by Paragraph 3.7.6, or
- b) Width required by Paragraph 3.3.2.

3.7.6 Aisle widths shall be no less than:

- a) 750 mm when serving up to 60 seats
- b) 900 mm when serving over 60 seats on one side only, or
- c) 1100 mm in all other cases.

The minimum width shall occur at:

- d) If discharge is in one direction only, the point furthest from the exit door in aisles, or
- e) If discharge is in two directions, the mid-length of an aisle to separate cross-aisles or to separate exit doors.

There is nothing to prevent an aisle being made wider than the minimum required. However, to avoid restrictions, this shall be done only in the direction of travel.

Figure 3.13 Fixed seating – with backs
Paragraph 3.7.4

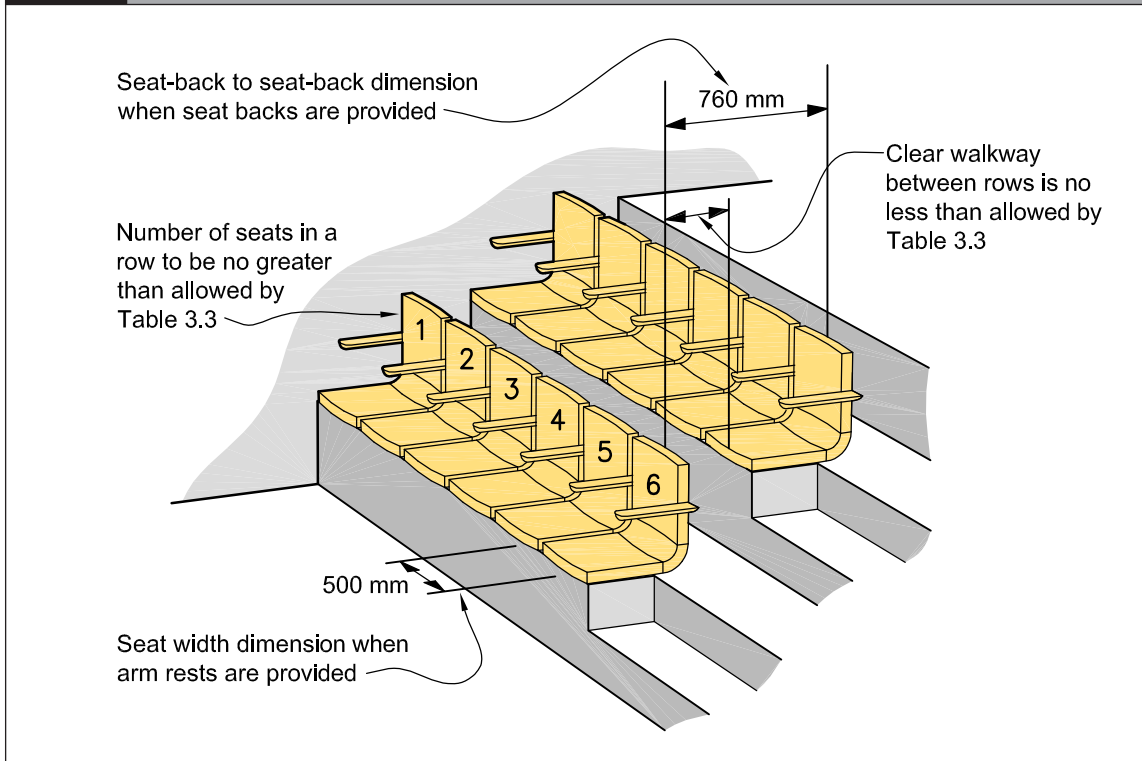

3.7.7 Each cross-aisle shall have a width of no less than that of the widest aisle it serves plus 50% of the sum of the widths of all other aisles served.

3.7.8 The *travel distance* from any seat to a *final exit* or *exitway* shall be no greater than allowed for an *open path* in Table 3.2. If there are sloping ceilings and floors, refer to Paragraph 3.4.5 for further restrictions.

3.7.9 Any side of an aisle that does not provide access to seating shall have barriers complying with Acceptable Solution F4/AS1 and *handrails* complying with Acceptable Solution D1/AS1.

3.7.10 Steps in aisles shall have equal riser heights and equal tread depths, both complying with the requirements of Acceptable Solution D1/AS1. Landing lengths in aisles shall be equal in each block of seating between cross-aisles, but may be less than the minimum length required by Acceptable Solution D1/AS1.

Comment:

This will result in an aisle which has a series of short landings connected by one or more uniform steps.

Loose seating

3.7.11 Loose seating is permitted only on level floors. The layout shall follow the requirements of Paragraphs 3.7.4 to 3.7.7.

3.7.12 Where the *occupant load* exceeds 250, loose seating shall be interconnected to prevent overturning.

Comment:

Generally, seats should be linked rigidly in blocks of at least four seats. Preferably, the block at each end, adjacent to each aisle, should be fastened to the floor. This is made easier if aisle widths are clearly marked on the floor.

Figure 3.14 Aisles serving fixed seating
Paragraph 3.7.5

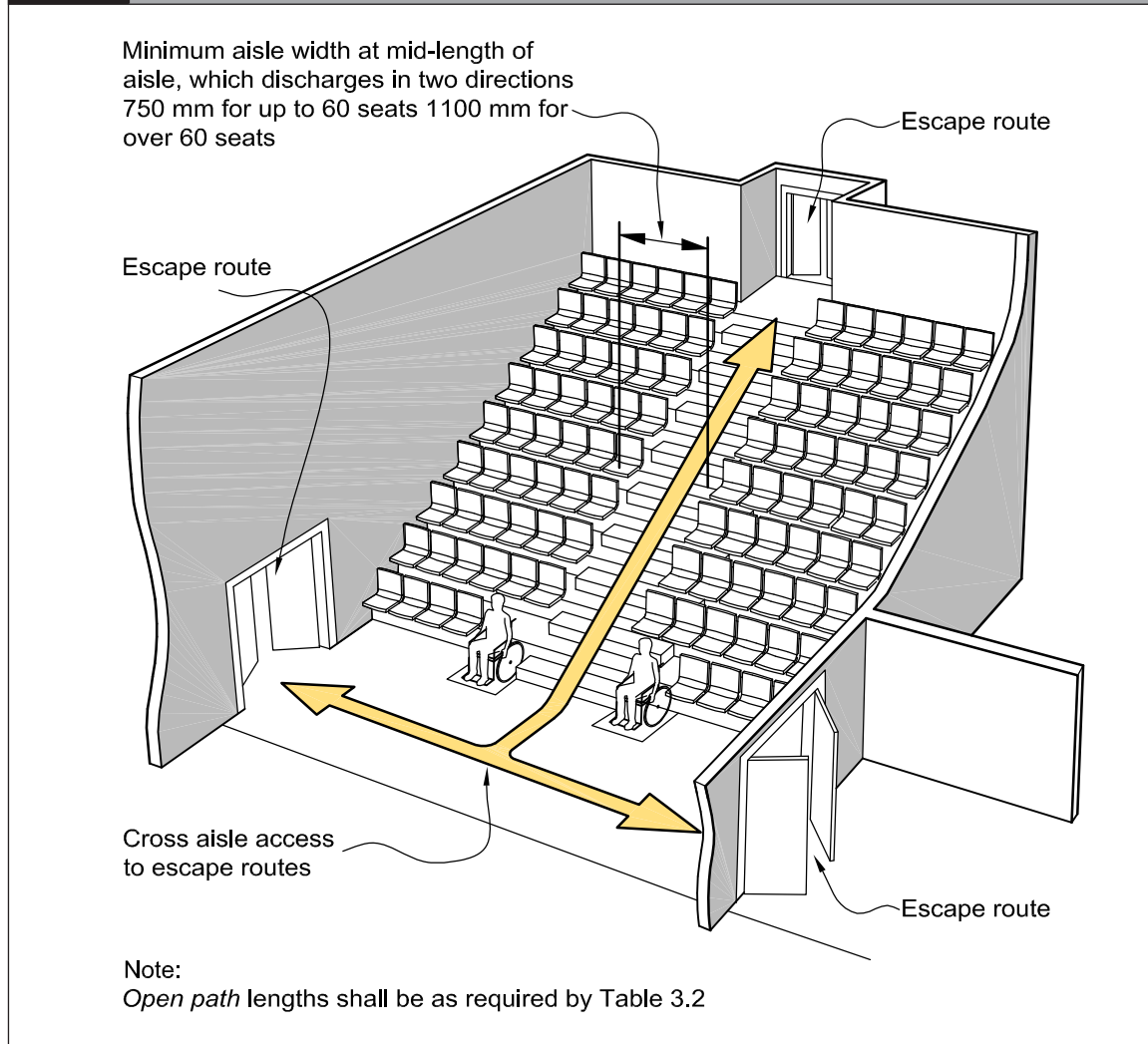

Passing into an adjacent firecell

3.7.13 An *open path* may pass into an adjacent *firecell* on the same level (see Figure 3.15) and recommence as a new *open path*, provided that:

- a) All *firecells* on the *escape route* have no fewer than two directions of escape, separated as required by Paragraph 3.6.2, and
- b) Adjacent *firecells* into which evacuation may take place have a floor area sufficient to accommodate not only their own occupants, but also the occupants from the adjacent *firecell*. This shall be calculated on the basis of the *occupant load* of the two *firecells*, and
- c) Each *firecell* has at least one other *escape route* independent of the route into the adjacent *firecell*. This other route may be by way of a *final exit* or via a third *firecell* provided that the exit from that third *firecell* is independent of exits from the other two *firecells*, and
- d) The *escape route* does not pass through more than three *fire separations* before entering an *exitway* or *final exit*, and
- e) The *escape route* width meets the requirements of Paragraph 3.3.2 for the *firecell* on the *escape route* that has the greatest *occupant load*.

Comment:

Open path lengths in each *firecell* are controlled by the requirements of Paragraph 3.4.2 for that *firecell*.

Refer to Paragraph 3.15.3 to determine whether doors between *firecells* need to be hung to swing both ways because escape may be in either direction, and to Paragraph 3.15.9 for *hold-open device* requirements.

Escape via an intermediate floor

3.7.14 An *open path* may pass from a *firecell* on to an *intermediate floor* and recommence as an *open path* provided that:

- a) Where two or more *escape routes* are required from that *firecell*, only one *escape route* shall be via the *intermediate floor*, and
- b) The *intermediate floor* is served by at least two *escape routes*, separated as required by Paragraph 3.6.2, and terminating at separate *firecells*, *exitways* or *final exits* at the same level as the *intermediate floor*, and
- c) The *intermediate floor open path* lengths shall not exceed the requirements of Paragraph 3.4.

Figure 3.15 Open path passing into adjacent firecells
Paragraphs 3.7.13 and 4.16.9

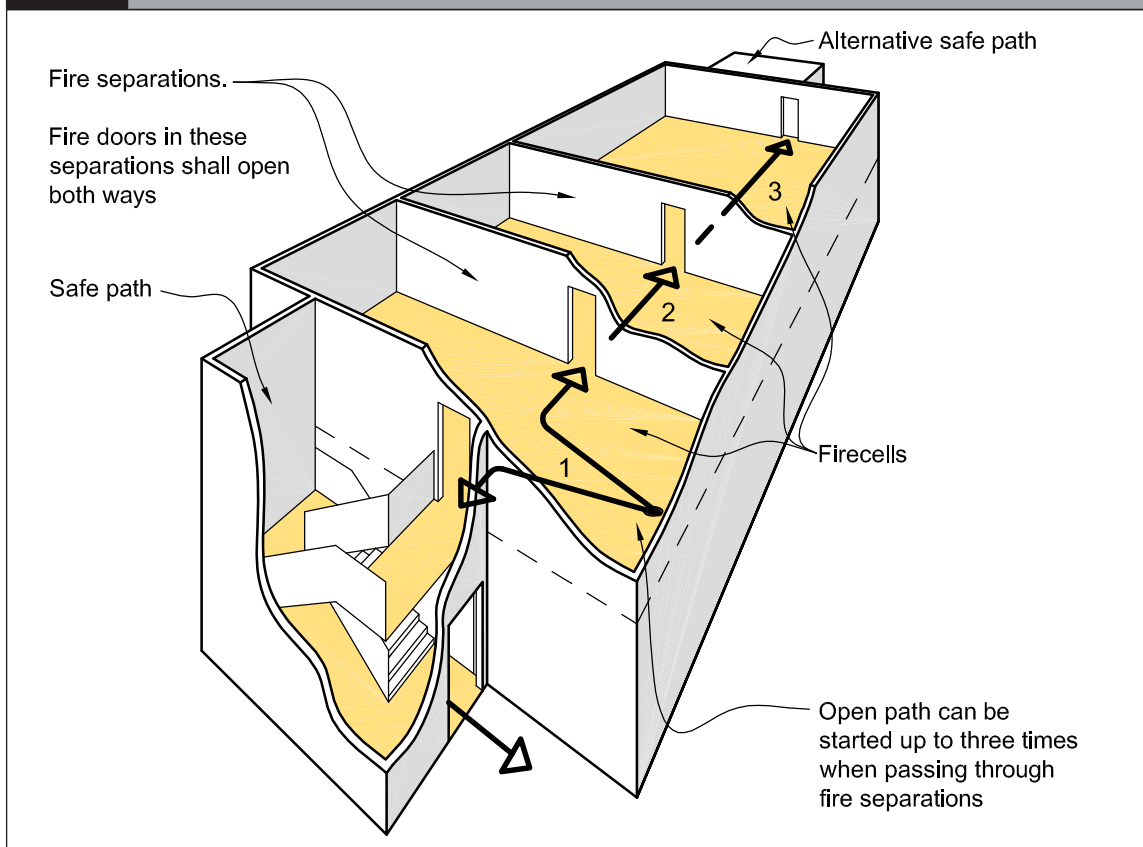

3.8 Dead ends

No more than 50 occupants

3.8.1 A *dead end* shall not serve an *occupant load* greater than 50.

Ladders

3.8.2 The *escape route* from a *dead end* may be a ladder complying with Acceptable Solution D1/AS1 if it serves only support activities or provides the same function in support of other *risk groups*, and only if the *occupant load* does not normally exceed four. Ladders are not permitted as *escape routes* in any other circumstances (see also Paragraph 3.4.4.).

Comment:

This provision is principally for situations such as catwalks used intermittently and fly-towers over stages.

3.9 Exitways

3.9.1 *Exitways* consist of *smoke lobbies* and *safe paths*.

Smoke lobbies – floor area

3.9.2 If a *smoke lobby* is required preceding a vertical *safe path* (see Paragraphs 3.5.1 and 3.9.3 and Figure 3.16), its floor area shall be calculated for the *occupant load* using that *smoke lobby* by assuming that:

- a) Part of the *occupant load* will be accommodated in the *stairway* vertical *safe path* between the level being considered and the next level in the direction of escape, with the remaining occupants accommodated in the *smoke lobby*, and
- b) The occupant density for calculating the required holding area is 0.25 m² per person in the *stairway*. The floor area shall be taken as the area of the first landing plus the plan area of the flights of stairs between the two floor levels plus the areas of any intermediate landings. Additional space shall be provided for door swings.

Comment:

This paragraph does not call up a requirement for a *smoke lobby*, but when they are required by other parts of this Acceptable Solution, this Paragraph states how *smoke lobbies* are to be sized.

Figure 3.16 Sizing of smoke lobbies
Paragraph 3.9.2

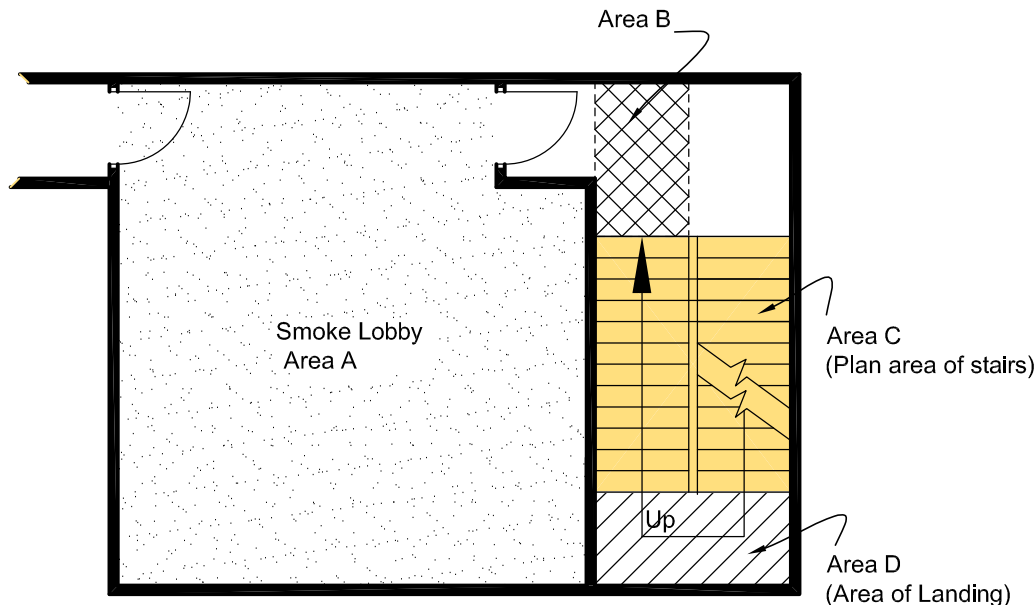

Size of smoke lobby (Area A) required =
Number of persons to be accommodated x 0.25 minus (Area B + Area C + Area D)

Smoke lobbies – Exitways from upper and intermediate floors

3.9.3 Entrances to vertical *safe paths* shall be preceded by *smoke lobbies* (refer to Paragraph 3.9.2 for the required area of the *smoke lobby*) except where:

- a) The *safe path* from an upper floor or *intermediate floor* serves only that floor, or
- b) The *firecell* is sprinklered, or
- c) The *occupant load* of the *firecell* is less than 150, or
- d) The vertical *safe path* is preceded by a horizontal *safe path*.

Comment:

An upper floor is any floor above *final exit* level.

Safe paths

3.9.4 *Escape routes* from *firecells* shall enter directly into a *safe path* or *final exit*, except where Paragraph 3.7.13 permits *open paths* to continue from one *firecell* to another.

3.9.5 *Safe paths* shall be separated from each other and from all spaces by:

- a) *Fire separations*, or
- b) If they are external to the *building*, by distance or appropriate *construction* (see Paragraph 3.11).

3.9.6 THIS PARAGRAPH DELIBERATELY LEFT BLANK

Safe path length restrictions

3.9.7 There is no limit on the length of a vertical *safe path*. Horizontal *safe paths* shall be no longer than specified in Table 3.4.

Table 3.4 Travel distances on horizontal safe paths				
	No system and Type 2 system	Type 4 system	Type 6 system	Type 7 system
Single direction	20 m	40 m	40 m	60 m
Two or more directions	150 m	Unlimited	Unlimited	Unlimited

If *open path* length increases for a Type 4 system are being applied, where Acceptable Solution F7/AS1 allows heat detectors to be substituted for smoke detectors then at least 70% of the *firecell* shall be protected with smoke detectors. It is not permitted to substitute the smoke detection in *exitways*.

Safe path termination

3.9.8 Horizontal *safe paths* shall terminate at any of the following:

- a) The entrance to an internal *stairway* which is a separate *safe path*, or
- b) An external balcony leading to either an open or enclosed *stairway*, or
- c) An opening in an *external wall* which enters on to a bridge leading to an open or enclosed *stairway*, or
- d) A *final exit*.

Comment:

Long *safe path* corridors may be required to be subdivided by *smoke separations* (see Paragraph 4.12).

A vertical *safe path* may be required to have mid-height *smoke separation* (see Paragraph 4.9.7).

Safe path separation, glazing and smoke separation

3.9.9 The vertical and horizontal portions of internal *safe paths* shall be separated at every floor level by *fire separations* and *fire doors* with smoke control capability.

3.9.10 Glazing in *safe paths* shall comply with the requirements of Paragraph 4.2.

3.9.11 THIS PARAGRAPH DELIBERATELY LEFT BLANK

3.10 Control of exitway activities

3.10.1 *Exitways* shall not be used for:

- a) Any storage of goods, solid waste or solid waste containers, or
- b) For entry points to solid waste chutes, or
- c) The location of furniture or other *combustibles*, or
- d) Storage of cloaks or linen, or
- e) A cleaner's cupboard not *fire separated* from the *exitway*, or
- f) The location of an electrical switchboard or similar, or
- g) Any activity (other than as permitted by Paragraph 3.10.2).

3.10.2 Some activities are permitted in an *exitway* if:

- a) An alternative *escape route* is available from all *firecells* served by the *safe path* in which the activities occur, and
- b) For *building occupant loads* up to 500 a Type 4 system is installed and for *occupant loads* exceeding 500 a Type 7 system is installed. These systems shall be installed in the *exitway* and connected to alerting devices installed throughout the *building*, and
- c) The *escape route* is not impeded by the activity or by the occupants involved in that activity, and
- d) Those activities:
 - i) are visible to users of the *exitway*, except in the case of *sanitary fixtures*, and
 - ii) exist only to provide support functions to the activities of the *risk group* served by the *exitway*.
 - iii) DELIBERATELY LEFT BLANK

Lifts

3.10.3 A passenger lift, but not a goods lift, may be located in a vertical *safe path* containing a *stairway* provided the following conditions are satisfied:

- a) The lift shaft and all its openings are located entirely within a single *firecell* containing the vertical *safe path*, and
- b) Passenger access into and from the lift takes place entirely within the *safe path*, and
- c) No other activity occurs within the vertical *safe path*, and
- d) The lift machine room is a separate *firecell* and the openings for lift ropes through the *fire separation* are as small as practicable, and any *penetrations*, such as for electrical cables, are *fire stopped* (see Paragraph 4.4).

3.10.4 Lift landings located in *open paths* (see Figure 3.17) shall be either within a *smokecell* separated from all other areas or have lift landing doors with smoke control capability. This requirement does not apply if the *building* is protected with a Type 7 system. The lift doors shall be as specified in Paragraph 4.16.3 and 4.16.11.

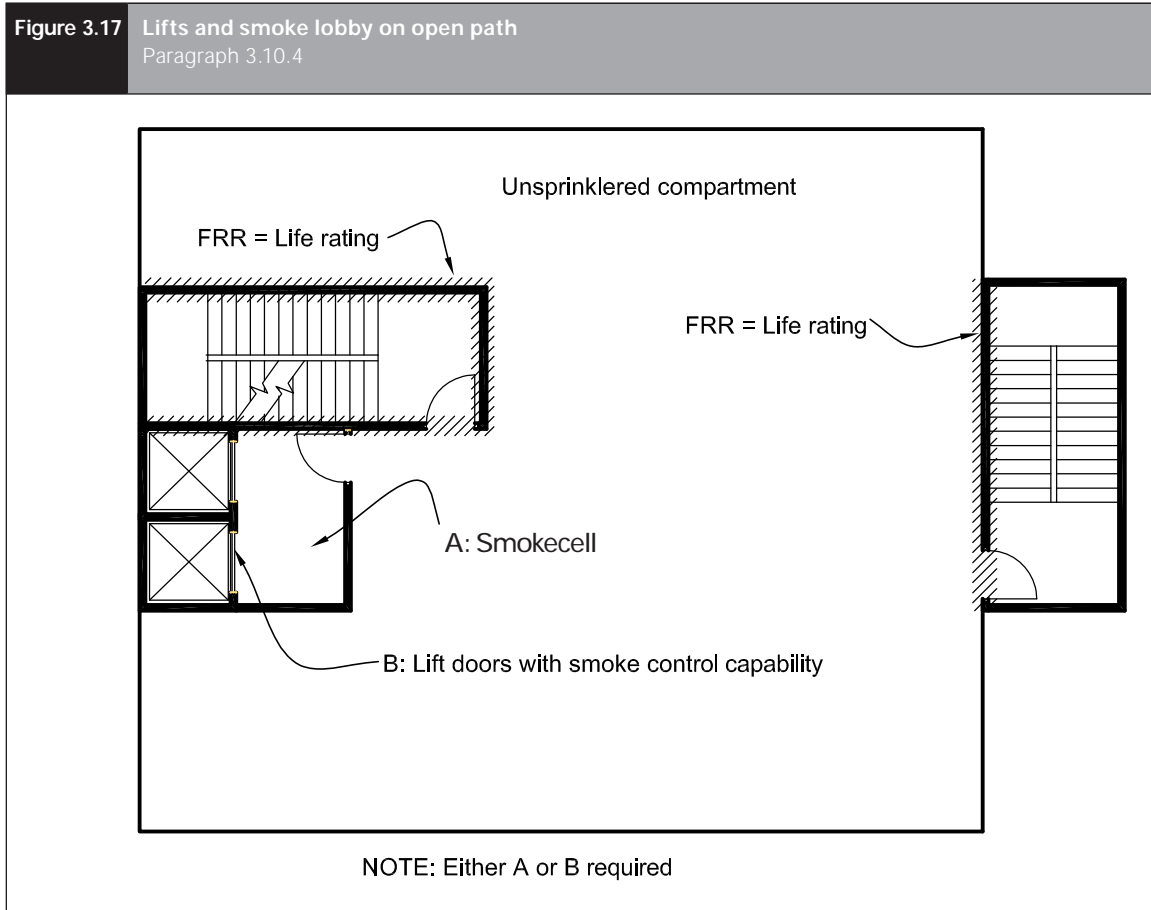

3.11 External escape routes

3.11.1 Where an *escape route* enters a space exposed to the open air (eg, an open *stairway*, a balcony, across a roof or a ground level path), it shall meet the requirements for a *safe path* between that point and the *final exit*. *Safe path* separation requirements shall be achieved by providing either distance or *fire rated construction* between the *escape route* and adjacent *firecells*, as specified in Paragraphs 3.11.2 to 3.11.6.

Comment:

Balconies with one direction of escape comply with the requirements of a *safe path* if the *external wall* beside the balcony has no *unprotected areas* or if the balcony is large enough to allow separation by distance from the *external wall* (see Paragraph 3.11.2). Balconies with two directions of escape from all *firecell* exits are also considered to be *safe paths*, even if the adjacent *external wall* has 100% *unprotected area*.

Separation by distance

3.11.2 Separation by distance shall be achieved by:

- a) If there is only one direction of escape, roofs and *external walls* with no *unprotected areas* closer to an external *escape route* than:
 - i) 2.0 m if any *firecell* passed by the external *escape route* is unsprinklered (see Figure 3.18), or
 - ii) 1.0 m if all *firecells* passed by the external *escape route* are sprinklered, or

Comment:

This provision is to limit heat radiation exposure to occupants who have only one direction of escape. Therefore, the limiting distances apply horizontally to both sides of the *escape route*.

- b) Locating the *escape route* so that it diverges from *external walls* (see Paragraph 3.11.5 a)), or

Figure 3.18 External escape routes
Paragraph 3.11.2

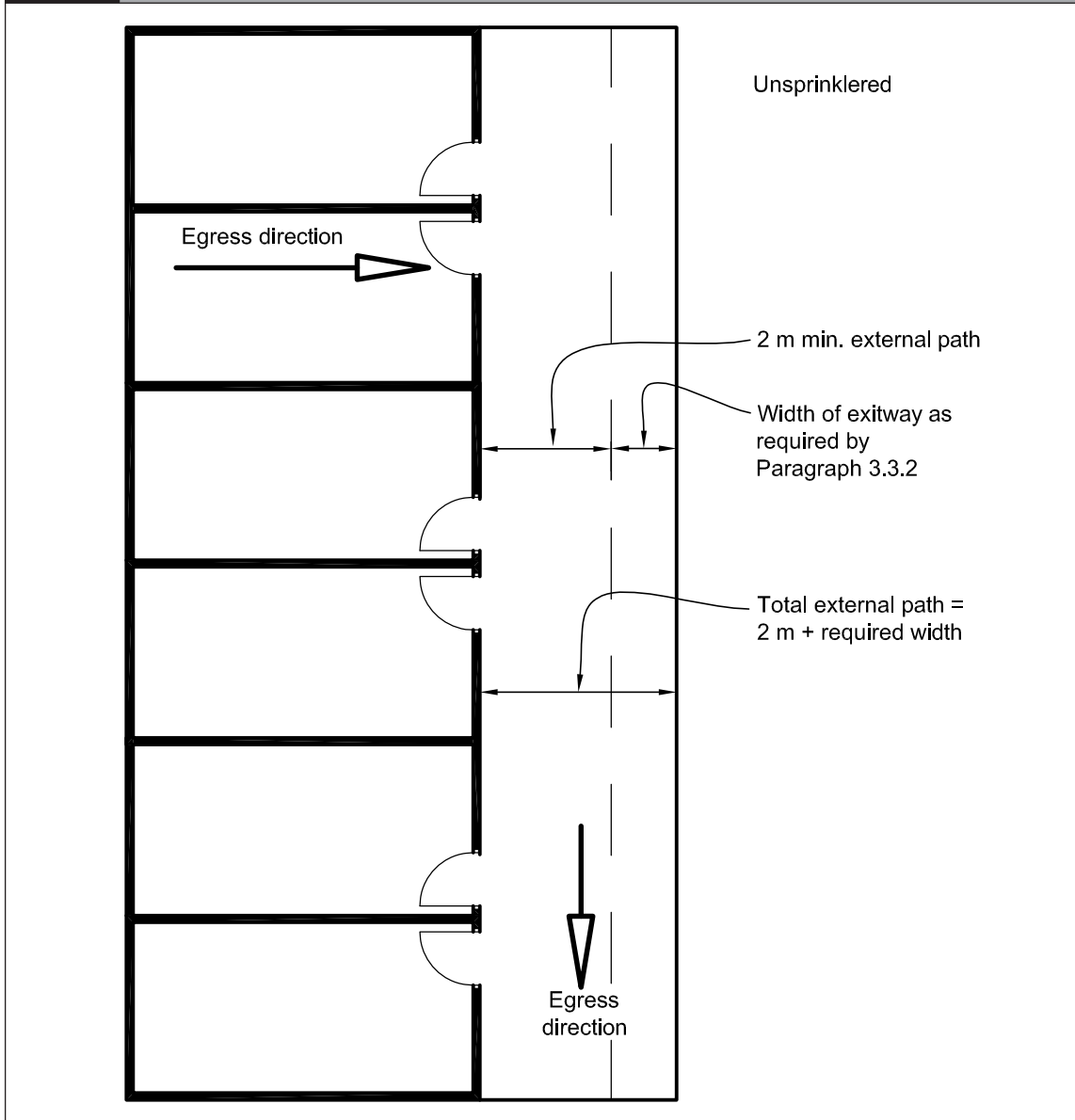

c) Providing alternative directions of escape from the point where the *escape route* passes through an *external wall* and becomes an *external escape route* (see Paragraph 3.11.5 b)).

3.11.3 THIS PARAGRAPH DELIBERATELY LEFT BLANK

3.11.4 If the distance separating *external walls* or roofs from an external *dead end escape route* is less than that permitted by Paragraph 3.11.2, those walls and roofs shall comply with the *FRR* requirements of Paragraph 5.3. Glazing shall comply with Paragraph 4.2. The *FRR* shall be in accordance with Paragraph 2.3.

3.11.5 For an *escape route* which passes through an opening in an *external wall*, the *external wall* need not be *fire rated* if:

- a) The direction of escape to a single *final exit* diverges from the *external wall* at an angle of no less than 45° in plan, or
- b) The directions of escape to alternative *final exits* diverge from each other at an angle of no less than 90° in plan and the directions of escape do not travel past any *firecell* for a distance of more than 5.0 m.
- c) DELIBERATELY LEFT BLANK
- d) For shopfronts, if the exit is onto the footpath it is not required to be *fire rated*.

Comment:

The relaxation of *FRR* requirements does not apply where *fire rated construction* is necessary due to the proximity of a *relevant boundary* (see Paragraph 5.3).

Separation by fire rated construction

3.11.6 Except where the separation distance requirements of Paragraphs 3.11.2 a) or 3.11.5 are achieved:

- a) *External walls* and roofs adjacent to external *escape routes* shall comply with the *FRR* requirements of Paragraphs 5.3 and 5.7 and shall have no *unprotected areas*, except that glazing for *safe paths* complying with Paragraph 4.2 shall be permitted, and
- b) If the *escape route* is a balcony with a single direction of escape and the vertical distance between the underside of the balcony and the closest *unprotected area* in the *external wall* below is less than 5.0 m (see Figure 3.19), balcony barriers shall:
 - i) have no openings, and
 - ii) be protected with a material having a *Group Number* of no greater than 2, and

Comment:

See Verification Method C/VM2 Appendix A for the method of assigning the *Group Number*.

Figure 3.19 Open balconies
Paragraphs 3.11.6 and 3.11.7

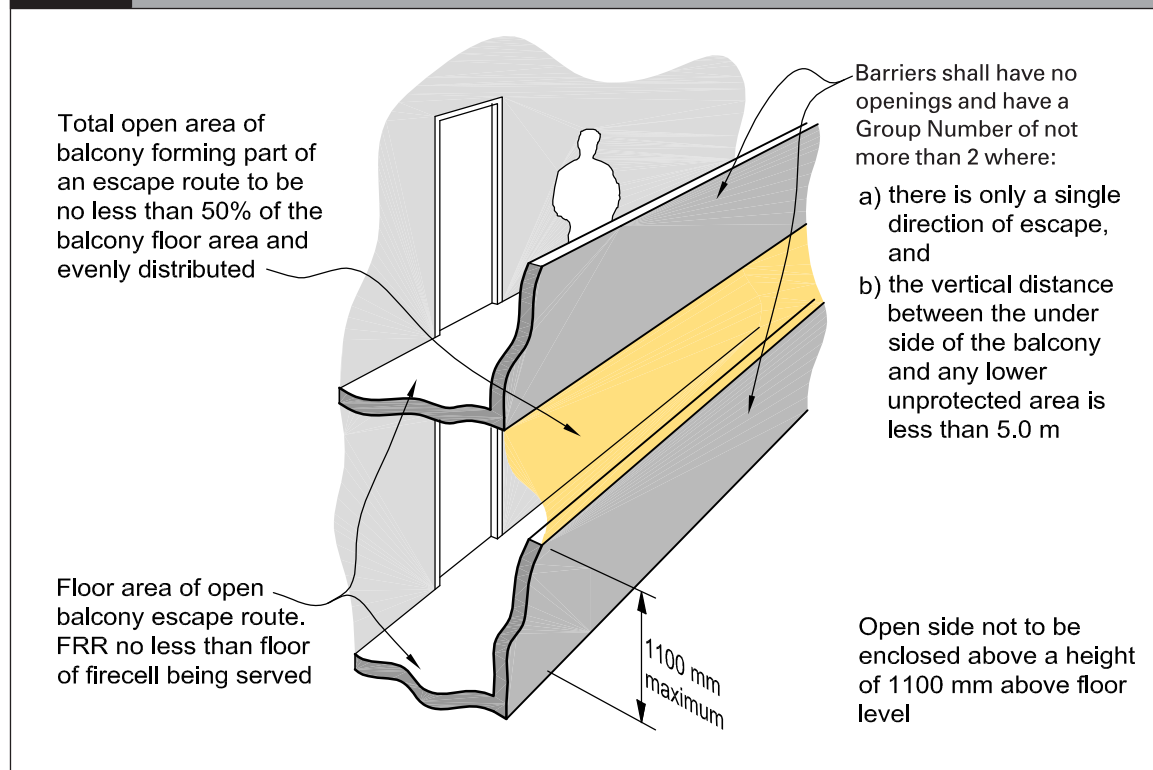

- c) If the vertical separation between the underside of an external *escape route* and *unprotected areas* in the *external wall* below is less than 5.0 m:
- i) the floor of any external *escape route* closer than 2.0 m to an *external wall* than required by Paragraph 3.11.2 shall have an *FRR* of no less than required by Paragraph 2.3, except that this does not apply if the *escape route* is a balcony with two directions of escape, and
 - ii) treads and risers of stairs on external *escape routes* shall either be *constructed* from a material with a critical radiant flux of no less than 2.2 kW/m² or shall be protected on the underside with a material having a *Group Number* of no greater than 2, and

Comment:

If the *escape route* is a balcony with two directions of escape, the *external wall* does not need to be a *fire separation* and the requirements for the floor of the balcony c) i) and the barrier b) do not apply.

- d) If the *escape route* comprises external horizontal and internal vertical *safe paths*, a *smoke separation* shall be provided between them.

Ventilation openings

3.11.7 The open area of a balcony or bridge shall be no less than 50% of the balcony floor area and shall be evenly distributed along the open sides and any approach ramp (see Figure 3.19). Where an *escape route* on a balcony is served by an open *stairway*, similar ventilation shall be provided on the *stairway*. Open sides shall not be enclosed above a height of 1100 mm from the floor, except that a fixed open grille may be used if it provides the required free air space.

Barriers

3.11.8 Changes in *exitway* floor level other than in the direction of travel shall have barriers that comply with Acceptable Solution F4/AS1.

Open air auditoriums

3.11.9 Open tiered seating decks shall:

- a) Have the number of *escape routes* required by Paragraph 3.2.2 for the *occupant load*, and
- b) Comply with Paragraphs 3.7.4 to 3.7.11 for aisles and walkways between seats (Table 3.3 permits seat numbers to be doubled in this use), and
- c) Have *exitways* spaced at no more than:
 - i) 60 m apart where the space below the seating deck is required to be *fire separated* (see Paragraph 4.8.2), or
 - ii) 20 m apart where the space below requires no *fire separation*, and
- d) Be served by *escape routes* completely open to the air where the seating deck is not a *fire separation*.

3.11.10 If the seating deck is required to be a *fire separation*, an *escape route* may pass through the deck and the space below, provided that part of the *escape route* is a *safe path* with an *FRR* in accordance with Paragraph 2.3.

3.12 Final exits

Final exit separation

3.12.1 *Final exits* which open onto the same *safe place* shall be spaced no closer than 5.0 m centre to centre. This applies to both internal and external *exitways*.

Comment:

This provision allows quick dispersal and reduces the risk of a crowd blocking a *final exit*.

3.13 Single escape routes

3.13.1 Single *escape routes* shall only be permitted if:

- a) The *open path* length does not exceed the limits specified in Table 3.2, and
- b) The total *occupant load* from all *firecells* on each level served by the *escape route* is no greater than 50, and

- c) The number of preschool children receiving child care or *people with a disabilities* (including those using workshops and dining rooms) on any floor is not greater than 10, and
- d) The *escape height* is no greater than:
 - i) 10 m if unsprinklered, or
 - ii) 25 m if sprinklered, and
- e) In *buildings* with two or more floors, the vertical *safe path* is preceded by a *smoke lobby* on all floors except the topmost floor and the area of the *smoke lobby* is as specified in Paragraph 3.9.2, and
- f) There are no more than two *basement* levels below ground and the vertical *safe path* from the *basement* levels is preceded by a *smoke lobby* (see Figure 3.11).

3.13.2 THIS PARAGRAPH DELIBERATELY LEFT BLANK

3.13.3 THIS PARAGRAPH DELIBERATELY LEFT BLANK

3.13.4 THIS PARAGRAPH DELIBERATELY LEFT BLANK

3.13.5 THIS PARAGRAPH DELIBERATELY LEFT BLANK

3.14 THIS PARAGRAPH DELIBERATELY LEFT BLANK

3.15 Doors subdividing escape routes

Door closers and latching

3.15.1 Except as permitted by Paragraph 3.15.7 (revolving doors, automatic doors and access control systems), doors on *escape routes* shall satisfy the following requirements:

- a) They shall be hinged or pivoted on one vertical edge only, except that sliding doors may be used where the space, including an *exitway*, has an *occupant load* of less than 20. Roller shutter doors or tilt doors shall not be used as *escape route* width, except in an intermittently occupied space where the roller shutter door is the only *access route* and is open at all times the space is occupied, and

Comment:

In shops fitted with roller shutters, whether solid or grilled, it is acceptable for these to be closed outside opening hours when the shops are not occupied by the public.

- b) *Fire and smoke control doors* shall be self-closing, and the self-closing device shall either be:
 - i) active at all times, or
 - ii) activated by releasing a *hold-open device* in response to operation of a smoke detector (see Paragraph 3.15.10), or
 - iii) a self-closer that is activated by operation of a smoke detector but that allows the door to swing freely at other times. The smoke detector requirements shall be the same as for a *hold-open device* (see Paragraph 3.15.10), and
- c) If doors are required to be secure, they shall be fitted with panic fastenings complying with Paragraph 3.15.13 and situated in accordance with Paragraph 3.15.12 or fitted with simple fastenings that can be readily operated from the direction approached by people making an escape complying with Paragraph 3.15.14, and
- d) They shall not be fitted with any locking devices unless these comply with Paragraph 3.15.2, and
- e) They shall have door handles which satisfy the requirements of Acceptable Solution D1/AS1 for use by *people with disabilities*, and
- f) They shall be *constructed* to ensure that the forces required to open these doors do not exceed those able to be applied:
 - i) with a single hand to release the latch (where fitted), and
 - ii) using two hands to set the door in motion, and
 - iii) using a single hand to open the door to the minimum required width.

Comment:

These requirements are based on the force requirements of Appendix C C6.1.3.

Locking devices

3.15.2 If the *building* is occupied, locking devices shall:

- a) Be clearly visible, located where such a device would be normally expected and, in the event of *fire*, designed to be easily operated without a key or other security device, and allow the door to open in the normal manner.

If the operation of a locking device is unusual, such as the pressing of a button close to the door, it shall have signage that complies with NZBC F8.3.1, and

Comment:

Examples of unacceptable locking or security devices are card access and keypad locks that are not interfaced with the *fire* alarm and detection systems.

- b) Not prevent or override the direct operation of panic fastenings fitted to any door, and
- c) If they are of an electromechanical type, they shall, in the event of a power failure or door malfunction, either:
 - i) automatically switch to the unlocked (fail-safe) condition, or
 - ii) be readily opened by an alternative method satisfying the requirements of Paragraph 3.15.2 a), and
- d) Not prevent people in vertical *safe paths* from entering other floors.

Comment:

One way of ensuring compliance with Paragraph 3.15.2 is to develop a *building* management plan.

A *building* management plan procedure should be approved by the *building consent authority* and should include a provision to ensure that all *escape route* doors are unlocked when anybody is lawfully in the *building*.

This Acceptable Solution does not prevent *owners*, for security purposes, from locking *escape route* doors when the *building* is unoccupied.

People escaping down a stair have to be able to move from one stair to another via a horizontal *safe path* corridor so that, if one stair becomes smoke-logged or unusable for any other reason, people can continue their escape along an alternative route. If the stair is a single means of escape, people will still need to move out of the stair and wait for rescue by emergency services within the floor.

Direction of opening

3.15.3 Doors on *escape routes* shall be hung to open in the direction of escape. However, this is not required if the number of occupants of spaces with egress using the door is no greater than 50. If escape may be in either direction, doors shall swing both ways. For manual sliding doors, see Paragraph 3.15.1.

3.15.4 THIS PARAGRAPH DELIBERATELY LEFT BLANK

Degree and width of opening

3.15.5 Doors on *escape routes* (see Figure 3.22) shall satisfy the following requirements:

- a) In *open paths*, provide an unobstructed opening width no less than 760 mm and, when multi-leaf, have no single leaf less than 500 mm wide. The minimum door opening width may be reduced to 600 mm if it is not required to be an *accessible route*, and
- b) Within *exitways* (including entry and *final exit* doors), reduce the minimum *exitway* width required by Paragraph 3.3 by no more than the 125 mm allowed under Paragraph 3.3.6 d) to:
 - i) 725 mm into horizontal *safe paths*, or
 - ii) 875 mm within horizontal *safe paths* and in vertical *safe paths*, and
- c) Open no less than 90°, and
- d) Open onto a floor area which:
 - i) extends for a distance of no less than the arc of the door swing, and
 - ii) is at the same level on both sides of the door for the full width of the *escape route*, and

Errata 1
Feb 2013

Comment:

A 20 mm threshold weather-stop is acceptable on external doors (see Acceptable Solution D1/AS1).

- e) When opened, not cause the door swing to obstruct the minimum required width of any *escape route*. For example, doors which open onto a corridor used as an *escape route* shall not obstruct the minimum required width of that *escape route* (see Figure 3.23).

Figure 3.22 Degree and width of openings
Paragraphs 3.3.6 d) and 3.15.5

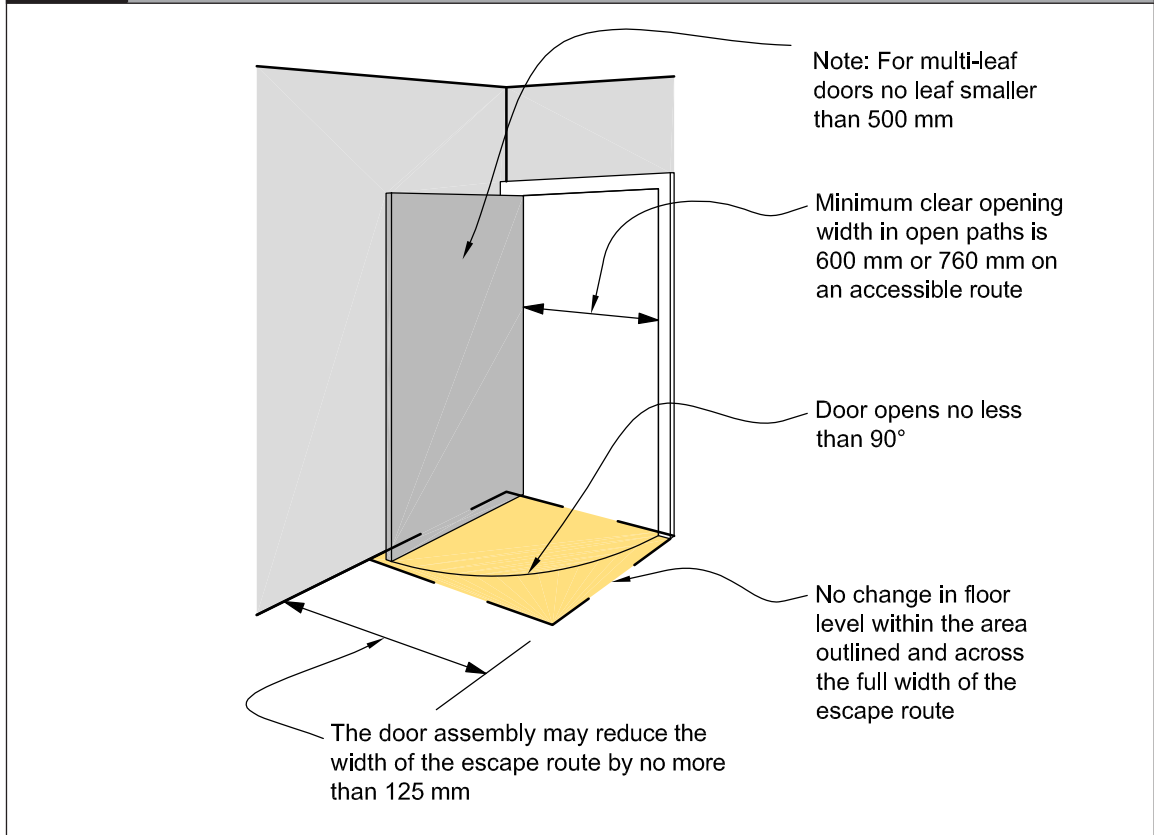
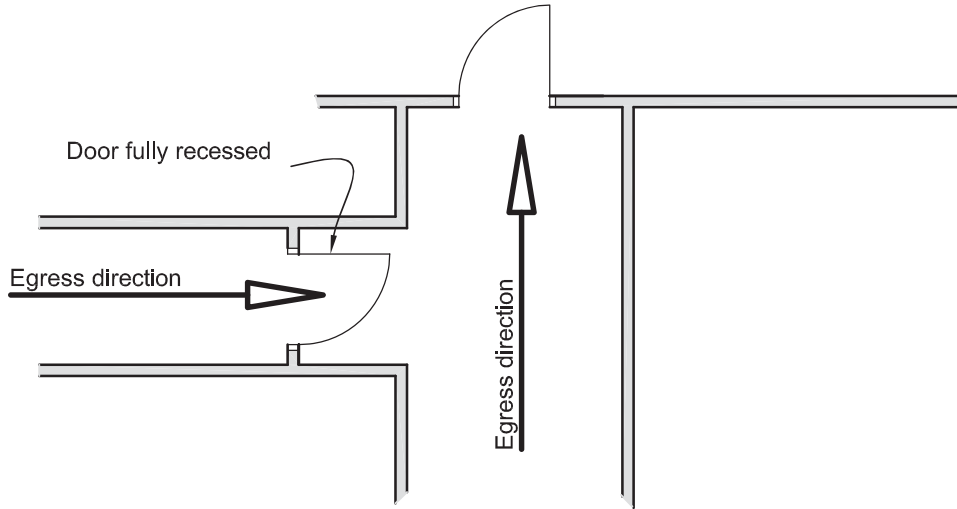
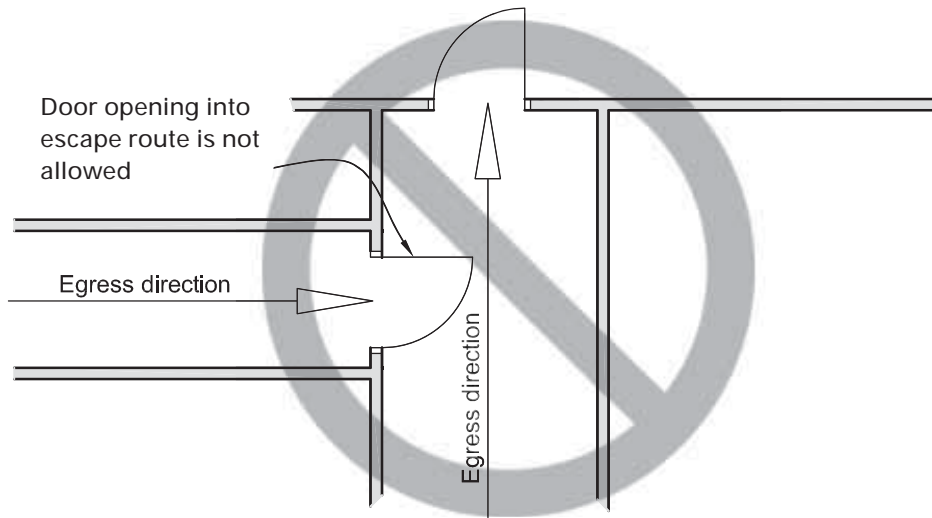

Figure 3.23 Door opening
Paragraph 3.15.5 e)



(a) CORRECT DOOR OPENING



(b) INCORRECT DOOR OPENING

Vision panels

3.15.6 Vision panels shall be provided on doors which:

- a) Are hung to swing both ways, or
- b) Lead into, or are within, *exitways* that swing in the direction of escape, or
- c) Subdivide corridors used as *escape routes*.

Revolving doors, automatic doors and access control systems

3.15.7 Revolving doors (see Figure 3.24 a)), automatic doors of all types and access control systems shall:

- a) Not be allowed across an *escape route* at any point leading into or within an *exitway*, but
- b) Be allowed in an *open path* or at a *final exit* provided that, in the event of a power failure or malfunction, the doors or access control systems continue to provide a safe *means of escape from fire* without reducing the required width by:
 - i) automatically opening and remaining open, or
 - ii) being readily pushed to the outward open position by the *building* occupants in an emergency (refer to Figure 3.24 b)).

Comment:

Access control systems may be in the form of turnstiles or entrance gates, in both horizontal and vertical planes. These are usually found in shopping centres, entertainment venues and similar occupancies.

The requirements in ii) are based on the force requirements in Appendix C C6.1.3.

3.15.8 Paragraph 3.15.7 b) need not apply if alternative swing doors of the required width are provided immediately adjacent to the revolving or sliding doors. See Paragraph 3.16 for signage requirements.

Hold-open devices

3.15.9 Detector activated *hold-open devices* shall be fitted to all *fire doors* or *smoke control doors* required:

- a) Between *open paths* and *exitways* if the *occupant load* is greater than 1000, and
- b) For subdividing long corridors (see Paragraph 4.12), and
- c) In *fire separations* where an *escape route* passes into an adjacent *firecell* (see Paragraph 3.7.13), and

Comment:

An example of c) would be between a horizontal *safe path* or *smoke lobby* and a vertical *safe path*.

- d) In locations where, due to the type or volume of occupant traffic using the doors, the doors may be kept open by unauthorised means.

Comment:

Hold-open devices are used where it is not practical to assume that *fire doors* and *smoke control doors* will remain closed because of the type or volume of occupant traffic using these doors. The devices should eliminate the unsafe practice of wedging or otherwise keeping self-closing doors open.

For the convenience of *building* occupants, it is often useful to provide a clearly-labelled push-button release adjacent to doors with *hold-open devices*.

3.15.10 Detectors for releasing *hold-open devices* shall be smoke detectors which are:

- a) Integral with the *hold-open device* and comply with Appendix C, or
- b) Located on the ceiling adjacent to the *doorset* on both sides of the *doorset*, or
- c) Part of an automatic smoke detection system on both sides of the *doorset*.

Figure 3.24 Revolving and automatic sliding doors
Paragraph 3.15.7

Revolving doors are permitted across an open path or final exit provided they are constructed to fail safely in an emergency.
Revolving doors are not allowed across an escape route leading to or within an exitway

Alternatively outward opening doors shall be provided immediately adjacent to the revolving doors

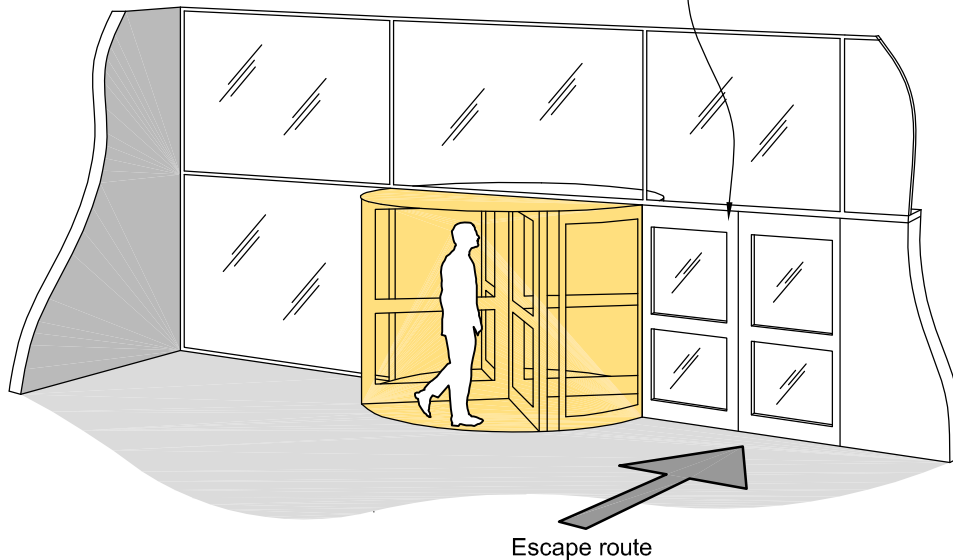

(a) REVOLVING DOORS

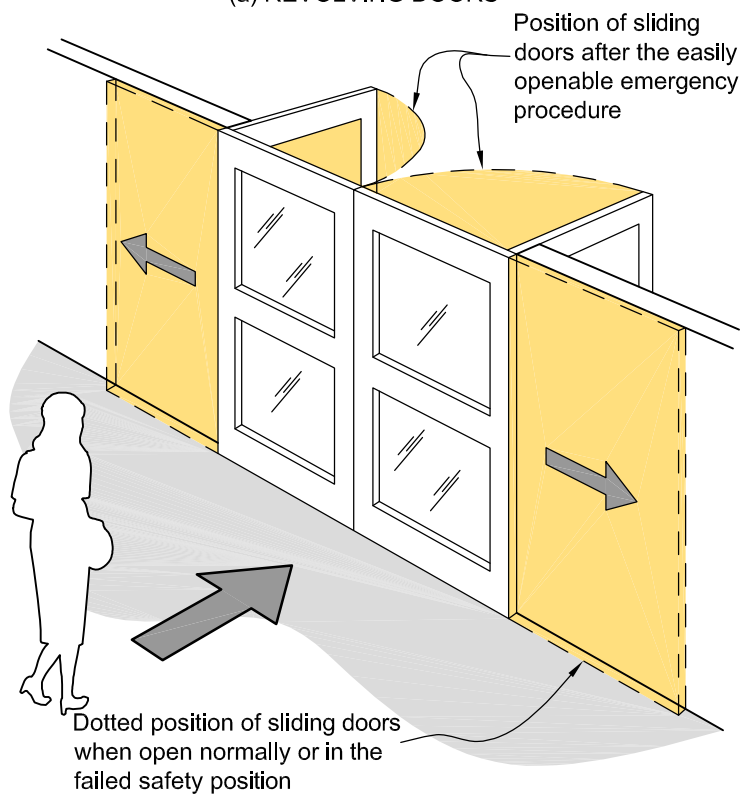

(b) SLIDING DOORS

Delayed action unlocking devices

3.15.11 Delayed action unlocking devices on *escape routes* shall be installed only if:

- a) The *firecell* is protected by a Type 4 or Type 7 alarm system, and
- b) *Fire* alarm activation instantly overrides any delay, and
- c) The delay in operation does not exceed 15 seconds, and
- d) Signage warning of the delay in operation and complying with NZBC F8.3.1 is provided.

Comment:

A delayed action unlocking device is a security mechanism that allows a door to be unlocked without using a key, but does not release the door under non-emergency conditions until after a time delay. The time delay allows the person intending to use the door to be checked for security reasons.

Panic fastenings

3.15.12 Panic fastenings shall be fitted on doors on the *means of escape from fire* including *exitways* and *final exits* in retail areas serving more than 500 occupants or for crowd occupancies of more than 100 people.

For all other areas, simple fastenings shall be fitted on doors on the *means of escape from fire*. This includes *exitways* and *final exits* which are required to be secured against entry when a *building* or part of a *building* is occupied.

Comment:

Doors that provide an exit from the *building* may do so either directly to a *safe place* (eg, *final exit* door) or to an area that gives access to a *safe place* (eg, an alleyway or bridge).

3.15.13 Panic fastenings are locking devices which shall meet the following requirements:

- a) The actuating portion shall consist of a horizontal bar or panel which shall extend across no less than half the width of the door leaf and shall be located between 800 mm and 1200 mm above the floor, and
- b) When a horizontal force of that able to be applied using one hand is applied to the bar or panel, the door lock shall release allowing the door to swing open freely.

Simple fastenings

3.15.14 Doors on *escape routes* (whether or not the doors are *fire doors*) shall be fitted with simple fastenings that can be easily operated from the direction from which people approach when making their escape.

Comment:

This generally excludes the use of keyed locks and bolt fastenings. See Paragraph 3.15.2 for security and safety.

3.16 Signs

.....

3.16.1 All *escape routes*, *fire doors* and *smoke control doors* shall have signs complying with NZBC F8.

Part 4: Control of internal fire and smoke spread

CONTENTS

- 4.1 Firecells
- 4.2 Glazing in fire and smoke separations
- 4.3 Structural stability during fire
- 4.4 Fire stopping
- 4.5 Firecell construction
- 4.6 Specific requirements for theatres
- 4.7 Specific requirements for exhibition and retail areas
- 4.8 Tiered seating
- 4.9 Exitways
- 4.10 Intermittent activities
- 4.11 Protected shafts
- 4.12 Long corridor subdivision
- 4.13 Floors
- 4.14 Subfloor spaces
- 4.15 Concealed spaces
- 4.16 Closures in fire and smoke separations
- 4.17 Interior surface finishes, floor coverings and suspended flexible fabrics
- 4.18 Building services plant

4.1 Firecells

4.1.1 *Firecells* shall be *fire separated* from each other by the *life rating* specified in Paragraph 2.3 of this Acceptable Solution if the *firecell* is categorised in *risk group CA* or by the higher of the two *life ratings* if it is categorised in another *risk group* (see Paragraph 2.3 of the relevant Acceptable Solution to determine that *life rating*).

4.2 Glazing in fire and smoke separations

4.2.1 Glazing in *fire separations* shall be fixed *fire resisting glazing* having the same *FRR* values for *integrity* and *insulation* as the *fire separation*, except where uninsulated glazing is permitted within vision panels and for sprinklered *buildings*.

4.2.2 Uninsulated *fire resisting glazing* having the same *integrity* value as the *fire separation* is permitted in *fire separations* in sprinklered *buildings* and in *external walls* in accordance with Paragraph 5.4.

4.2.3 There is no restriction on the area of glazing in *smoke separations* (including *smoke lobbies*). *Non-fire resisting glazing* may be used if it is toughened or laminated *safety glass*. Glazing shall have at least the same smoke-stopping ability as the *smoke separation*.

Fire doors and smoke control doors

4.2.4 Glazing in *fire doors* shall be *fire resisting glazing* having the same *integrity* value as the door. If the door requires an *insulation* value, an uninsulated vision panel may be used without downgrading the *insulation* value of the door. Vision panels shall comply with NZS 4520.

4.2.5 Glazing in *smoke control doors* shall meet the requirements for *smoke separations*.

4.3 Structural stability during fire

Stability of building elements having an FRR

4.3.1 To avoid premature failure, this Acceptable Solution requires the structural stability of primary *building elements* with an FRR to be retained for the duration of that FRR. *Primary elements*, located entirely within a *firecell* and providing support to *fire separations*, may need to be evaluated for *fire* exposure from multiple sides simultaneously.

Comment:

This situation arises when a *primary element*, such as a column or wall, located entirely within a *firecell* provides lateral support to a *firecell* boundary wall or vertical support to the *firecell* floor/ceiling. Results against the standard furnace test for *fire* resistance may not be a suitable as they commonly relate to exposure from one side only. Separate evaluation is required to assess the performance of *primary elements* when exposed to *fire* from more relevant sides simultaneously.

4.3.2 During a *fire*, *primary elements* shall resist collapse under:

- a) The design dead and live loads required by NZBC B1, and
- b) Any additional loads caused by the *fire*.

Comment:

NZBC B1.3.3 (c) and (i) requires that structural *stability* take account of vertical and horizontal loads, temperature and *fire* effects.

Additional loadings can arise from changes in length or other deformations in *building elements* as a result of high temperatures.

Yield strength of most materials generally reduces with temperature increase, so that strength reduction is related to the time for which the *primary element* is exposed to *fire*. Factors which need to be taken into account include the maximum temperature attained, the capacity of the element to absorb heat, potential loss of section, the degree of exposure, whether any applied coating is used to protect the element from the effects of *fire*, and the degree of restraint provided by the surrounding structure.

Unrated primary elements permitted

4.3.3 In many cases *primary elements* are rated for *structural adequacy*, and sometimes for *integrity* and *insulation*. However, *primary elements* need not have an FRR where any of the following circumstances exist:

- a) They are located outside an *external wall* which is 2.0 m or more from the *relevant boundary*, and are shielded from the effects of *fire* by protected areas of the wall (see Figure 4.1)
- b) They are added to strengthen an existing *building* and are required only to carry horizontal loads induced by wind or earthquake.

Figure 4.1 Permissible positioning of unrated primary elements
Paragraph 4.3.3

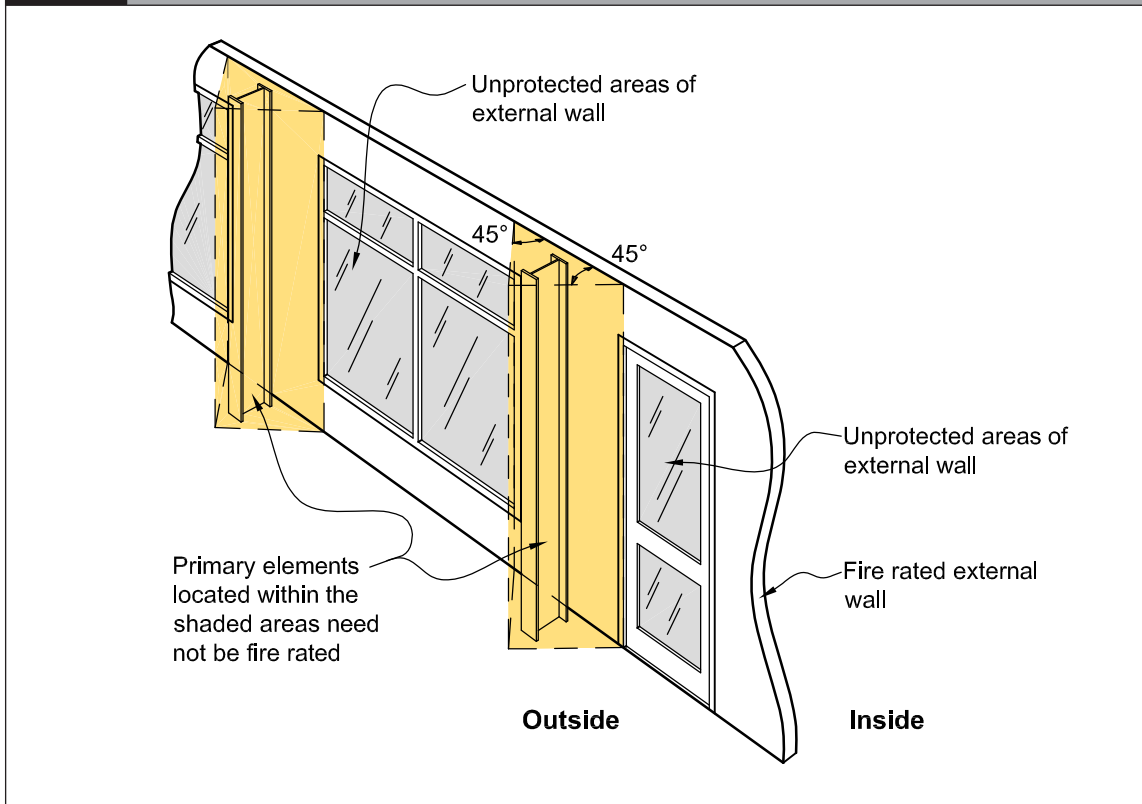

Providing vertical stability

4.3.4 Building elements required to have an FRR shall have their vertical stability provided in one or more of the following ways:

- a) Primary elements in a vertical orientation (eg, walls and columns) shall be rated for structural adequacy
- b) Primary elements in a horizontal orientation (eg, floors and beams) shall be supported by primary elements with at least an equivalent structural adequacy rating.

Providing horizontal stability

4.3.5 Building elements required to have an FRR shall have their horizontal stability provided in one or more of the following ways:

- a) Be cantilevered from a structural base having an FRR of no less than that of the building element concerned

- b) Be supported within the firecell by other building elements having an FRR of no less than that required for the element being supported. The structural adequacy and diaphragm action of supporting building elements, located entirely within a single firecell, must be assessed when exposed to fire from all relevant sides simultaneously
- c) Be supported by primary elements outside the firecell.

Comment:

It is assumed that fire will be restricted to the firecell of origin at least for the time required by the property rating of the primary element concerned.

The stability to a beam or fire separation may, for example, be provided by beam or diaphragm action of a floor or wall which is rated only for structural adequacy.

A standard test for fire resistance commonly exposes fire separations from one side only and may not be a suitable measure for determining the structural adequacy of a building element when exposed to fire from more than one side simultaneously.

4.4 Fire stopping

Introduction

4.4.1 The continuity and effectiveness of *fire separations* shall be maintained around *penetrations*, and in gaps between or within *building elements*, by the use of *fire stops*.

Fire stops

4.4.2 *Fire stops* shall have an *FRR* of no less than that required for the *fire separation* within which they are installed, and shall be tested in accordance with Appendix C C5.1.

4.4.3 *Fire stops* and methods of installation shall be identical to those of the prototype used in tests to establish their *FRR*.

4.4.4 The material selected for use as *fire stops* shall be approved for the type and size of the gap or *penetration*, and for the type of material and *construction* used in the *fire separation*.

Comment:

There are many types of *fire stops* (eg, mastics, collars and pillows). Each of these is designed to suit specific situations. A *fire stop* is appropriate for a particular application if it passes the test criteria when installed as proposed.

4.5 Firecell construction

4.5.1 Each of the *building elements* enclosing a *firecell* is permitted to have a different *FRR*, as this rating will depend on the characteristics of the *firecell*, the reason for the *FRR*, and the *risk groups* contained on either side of any *fire separation*.

Comment:

An *FRR* of zero may apply to some walls and most roofs.

4.5.2 Except where *intermediate floors* are permitted, each floor in a multi-storey *building* shall be a *fire separation*.

4.5.3 *Fire* and *smoke separations* shall have no openings other than:

- a) For closures such as *doorsets*, and
- b) *Penetrations* complying with Paragraph 4.4, and
- c) For glazing permitted by Paragraph 4.2.

4.5.4 *Firecell* and *smokecell* effectiveness shall be maintained by ensuring the continuity of *fire* and *smoke separations* at separation junctions and around joints where closures, *protected shafts* and *penetrations* occur.

Junctions of fire separations

4.5.5 Where *fire separations* meet other *fire separations* or *fire rated parts* of *external walls*, they shall either be bonded together or have the junction *fire stopped* over its full length (see Figures 4.2 and 4.3).

4.5.6 Where one *fire separation* is a wall and the other a floor, the wall/floor junction shall be *constructed* with the *FRR* required for the higher rated element.

Junctions with roof

4.5.7 Vertical *fire separations* and *external walls* shall either:

- a) Terminate as close as possible to the external roof cladding and *primary elements* providing roof support, with any gaps fully *fire stopped* (see Figures 4.2 and 4.3), or
- b) Extend not less than 450 mm above the roof to form a parapet.

Ceiling space firecells

4.5.8 Large roof or ceiling spaces may be *constructed* as separate *firecells* above more than one occupied *firecell* provided that the ceiling is a *fire separation* rated from below. In this situation, vertical *fire separations* in the *firecell* below need terminate only at the ceiling.

Sealing of gaps

4.5.9 To avoid the passage of smoke through *fire* and *smoke separations*, gaps shall be sealed with *fire resistant materials* complying with AS 1530.4 in their intended application if they are located:

- a) In *smoke separations* and between *smoke* and *fire separations*
- b) Around glazing in *smoke separations*
- c) Between *fire* or *smoke separations* and unrated parts of *external walls*.

4.5.10 Gaps around *penetrations* shall be *fire stopped* (see Paragraph 4.4).

Figure 4.2 Junctions of fire separations – 1
Paragraphs 4.5.5 and 4.5.7

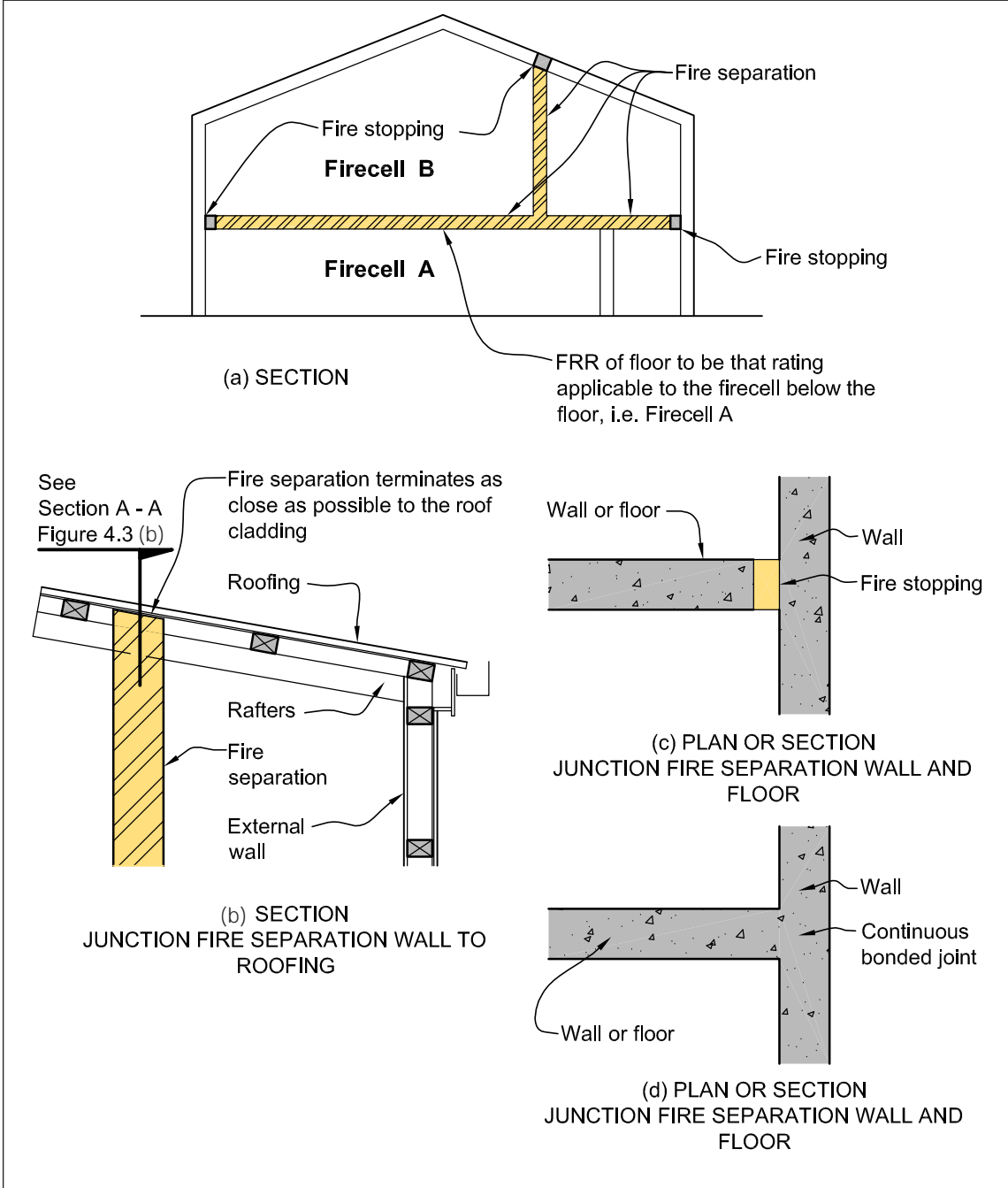
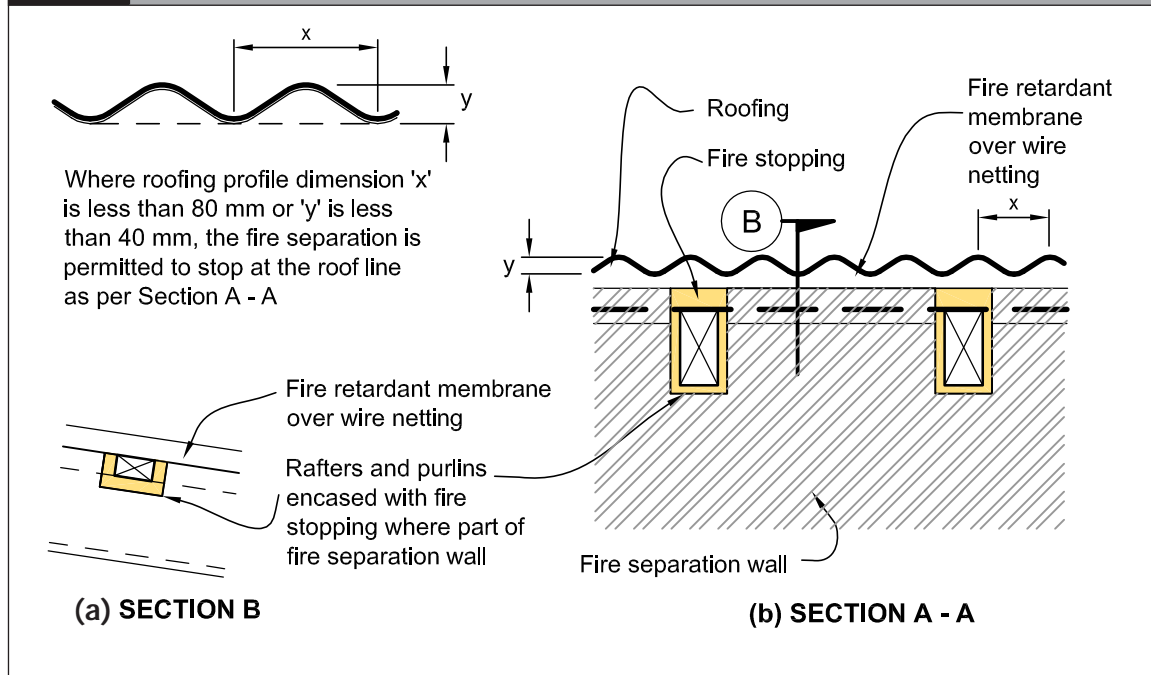

Figure 4.3 Junctions of fire separations – 2
Paragraphs 4.5.5 and 4.5.7



4.6 Specific requirements for theatres

Theatres

4.6.1 In every unsprinklered *theatre* where the *occupant load* in the auditorium is greater than 500, the stage area (including workshops, storerooms, scenery docks, property, wardrobe or painting rooms used in connection with the *theatre*), shall be separated from the auditorium by a proscenium wall meeting the requirements of a *fire separation* having an *FRR* of no less than 30/30/30. Where the stage and supporting areas are sprinklered as required by Paragraph 2.2, the proscenium wall and curtain may be a *smoke separation*. The openings in *fire* rated proscenium walls shall be protected as required by Paragraph 4.6.3.

Comment:

In determining the number of occupants on the floor, *occupied spaces* providing support functions need not be included.

Theatre stages

4.6.2 *Theatres* with an *occupant load* of greater than 1000 shall satisfy the following requirements:

- The stage area shall have roof vents of no less than 5% of the stage floor area, located at the highest point above centre stage. These vents shall have a positive device to keep them closed, and may be of the counterbalanced shutter type, inclined falling type, centre pivot sash type or counterbalanced skylight type, and they shall be held normally in a closed position by a heat sensing device installed below the vent opening and its controls, but above the discharge of any sprinkler head in the vicinity.
- Vents shall be capable of being operated by a manual control located near the stage safety curtain release, and
- The heat sensing device required by a) above shall be interlocked with any heating or ventilating system, so that when activated, it closes all *fire dampers* in all ducts passing through the proscenium wall.

Closures in theatre proscenium walls

4.6.3 The *fire resisting closure* (see Figure 4.4) to the stage opening in a *fire* rated proscenium wall shall be a *fire* curtain with an *FRR* in accordance with Paragraph 2.3. If the auditorium, stage area, and all spaces used for support activities are sprinklered, the sprinklers, or drenchers complying with NZS 4541, shall be located so that both sides of the *fire* curtain are kept wet in the event of *fire*.

4.6.4 The *fire* curtain, when released, shall free-fall and shall overlap the opening to inhibit the passage of smoke and flames. An emergency curtain release device shall be located in the stage area on both sides of the opening.

4.6.5 If a sprinkler system is not installed, uninsulated glazing is not permitted in *fire* rated proscenium walls.

4.6.6 THIS PARAGRAPH DELIBERATELY LEFT BLANK

4.6.7 THIS PARAGRAPH DELIBERATELY LEFT BLANK

4.6.8 THIS PARAGRAPH DELIBERATELY LEFT BLANK

4.6.9 THIS PARAGRAPH DELIBERATELY LEFT BLANK

4.6.10 THIS PARAGRAPH DELIBERATELY LEFT BLANK

4.7 Specific requirements for exhibition and retail areas

4.7.1 If the *occupant load* for a sales, exhibition or trade fair space is greater than 500, any adjacent storage areas in which goods are received, unpacked, stored or packed for despatch; any areas used for workshops; and any areas used for the storage of display material or similar items shall be *smokecells* separated from the display and sales areas.

4.8 Tiered seating

4.8.1 If any enclosed, useable space beneath permanent, tiered seating is not sprinklered, it shall be a *firecell* with an *FRR* in accordance with Paragraph 2.3.

4.8.2 If any enclosed, usable space beneath permanent tiered seating is sprinklered, it will not need to be a separate *firecell*. However, the supporting structure for the permanent tiered seating shall have an *FRR* in accordance with Paragraph 2.3.

4.8.3 Temporary and retractable tiered seating shall not require an *FRR*, provided the space beneath the seating is not used for storage.

4.9 Exitways

4.9.1 *Exitways*, unless external and separated by distance, shall comprise *smoke lobbies* in accordance with Paragraph 3.9.2 and/or *safe paths* which are *firecells*.

4.9.2 The *safe path* shall be separated from all adjoining *firecells* by *fire separations* with an *FRR* in accordance with Paragraph 2.3 throughout its length. If the *escape height* is greater than 10 m, the *fire separation* shall have an *FRR* meeting the *property rating*.

4.9.3 *Safe paths* which are stairs leading from lower floors or *basements*, and which continue to floors above the level of the *final exit*, shall have the lower levels *fire separated* from the *final exit* level. The *fire separation* shall have an *FRR* in accordance with Paragraph 2.3 or that required for the lower level, whichever is the greater.

4.9.4 *Safe paths* which are long corridors shall be subdivided by *smoke separations* in accordance with Paragraph 4.12.

4.9.5 Air ducts passing through *exitways* shall not include *combustible* materials.

4.9.6 THIS PARAGRAPH DELIBERATELY LEFT BLANK

Figure 4.4 Theatre proscenium walls
Paragraph 4.6.3

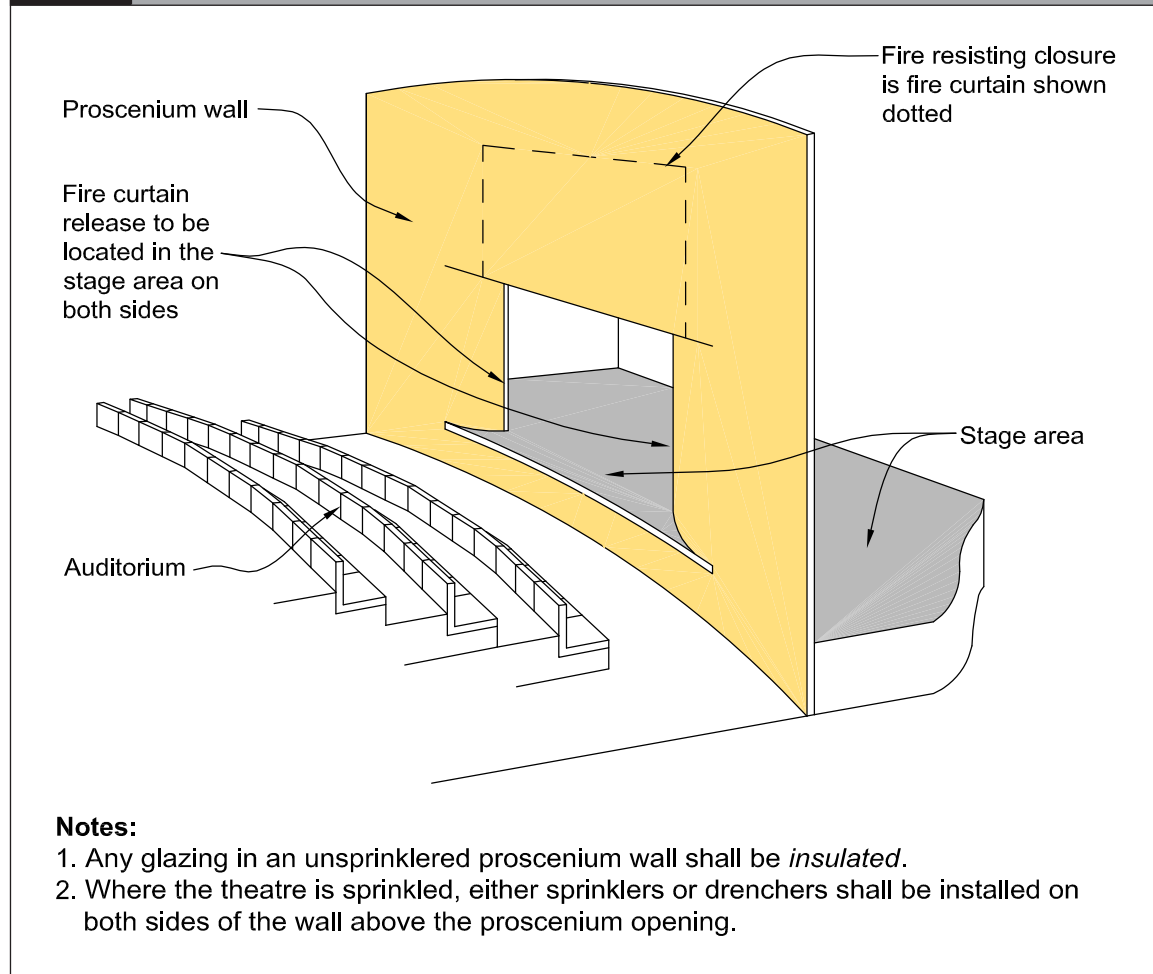

Vertical safe path smoke separation

4.9.7 Vertical *safe paths* which exceed a height of 25 m shall be divided by *smoke separations* and *smoke control doors* at the landing nearest mid-height. This requirement does not apply if the *building* is sprinklered.

separation, unless they are provided for enclosed waste storage or car parking. The *fire safety systems* required for each *risk group* shall also apply throughout these spaces. If these spaces are required to be separate *firecells*, they shall have *fire separations* with *FRRs* in accordance with Paragraph 2.3.

4.10 Intermittent activities

Support activities

4.10.1 Intermittent activities providing direct support to a primary activity of another *risk group* may be included with the other *risk group* and do not require *fire* or *smoke*

Comment:

Examples of spaces which provide support functions and are occupied intermittently include corridors, tearooms, ironing rooms, laundries, waiting rooms and kitchens in assembly halls.

Solid waste storage

4.10.2 Solid waste storage areas shall be enclosed when located adjacent to *occupied spaces*; in other situations these areas may be unenclosed. Enclosed solid waste storage areas within any *firecell* shall themselves be a separate *firecell* separated from adjacent *firecells* by *fire separations* having an *FRR* of no less than 60 minutes (see Paragraph 4.11.5 for waste chutes).

Plant, boiler and incinerator rooms

4.10.3 Any space within a *building* (see Figure 4.5) containing an incinerator, plant, boiler or machinery which uses solid fuel, gas or petroleum products as the energy source (but excluding space and local water heating appliances) shall be a separate *firecell* with an *FRR* of no less than 90 minutes, and shall have:

- a) At least one *external wall*
- b) External access that may be at any floor level including the roof. Where alternative internal access is provided, it shall be via a *smoke lobby* that is protected with a heat detector connected to a Type 2, 3, 4 or 5 system, and
- c) Its floor level no lower than the ground level outside the *external wall* if gas is the energy source.

4.10.4 If plant is contained in a *building* which is solely for the purposes of containing such plant, and that *building* is separated by 3.0 m or more from any adjacent *building*, only Paragraph 4.10.3 c) shall apply.

Figure 4.5 Plant, boiler and incinerator rooms
Paragraph 4.10.3

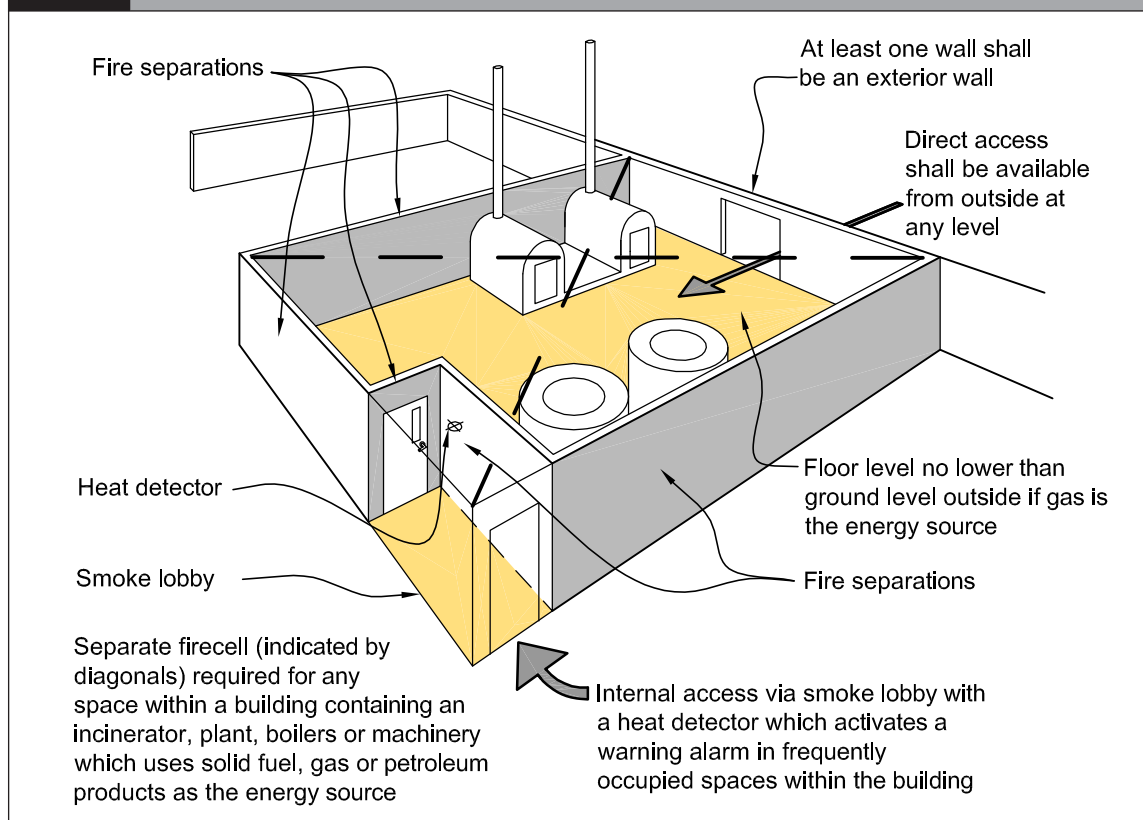

4.11 Protected shafts

Lifts, conveyors and services

4.11.1 Lifts, conveyors and services which pass from one *firecell* to another shall be enclosed within *protected shafts*.

Comment:

Paragraph 3.10.3 describes the requirements for the installation of a passenger lift in a vertical *safe path* containing a *stairway*. Paragraph 3.10.3 requires the vertical *safe path* to be a single *firecell*.

Fire separation

4.11.2 Every *protected shaft* shall be a separate *firecell* within the *firecell* or *firecells* in which it is located (see Figure 4.6). The shaft walls between each floor shall have an *FRR* of no less than that required by the *life rating* of the *risk group* for that level.

The *FRR* of the shaft wall shall apply to both sides equally, except in the case of lift landing doors (see Paragraph 4.16.11).

4.11.3 *Protected shafts* which do not extend through the roof or lowest floor shall be enclosed at their top and bottom by *construction* which satisfies the relevant requirements of Paragraph 4.4 for *fire stopping* (see Figure 4.6).

Openings in protected shafts

4.11.4 There shall be no openings in *protected shafts* except for:

- a) Access panels having an *FRR* of no less than that required for the shaft
- b) *Doorsets* providing access to lifts and complying with smoke control requirements
- c) Openings for lift ropes passing into a lift motor room, which shall be as small as practicable
- d) *Fire dampers* serving a ventilation duct and complying with requirements for *fire resisting closures*
- e) *Penetrations* which satisfy Paragraph 4.4 for *fire stopping*, or
- f) Fittings with an *FRR* of no less than that required for the *protected shaft*.

Solid waste and linen chutes

4.11.5 Solid waste and linen chutes which pass from one *firecell* to another shall be *protected shafts* or contained within a *protected shaft*. If the *building* is unsprinklered, each chute shall be equipped with automatic sprinkler heads connected to any water supply pipe capable of meeting the minimum design criteria for the selected sprinkler head. These sprinklers shall be installed at the top of each chute and in the space into which the chute discharges. The minimum residual pressure in the water supply pipe shall be 50 kPa with two sprinkler heads operating.

Comment:

The minimum residual pressure requirement for any operating sprinkler is to ensure sufficient flow rate and area coverage to control a *fire*.

4.11.6 Solid waste and linen chutes shall have no inlet or discharge openings within an *exitway*.

Figure 4.6 Protected shafts
Paragraphs 4.11.2, 4.11.3, 4.13.1 and 4.13.2

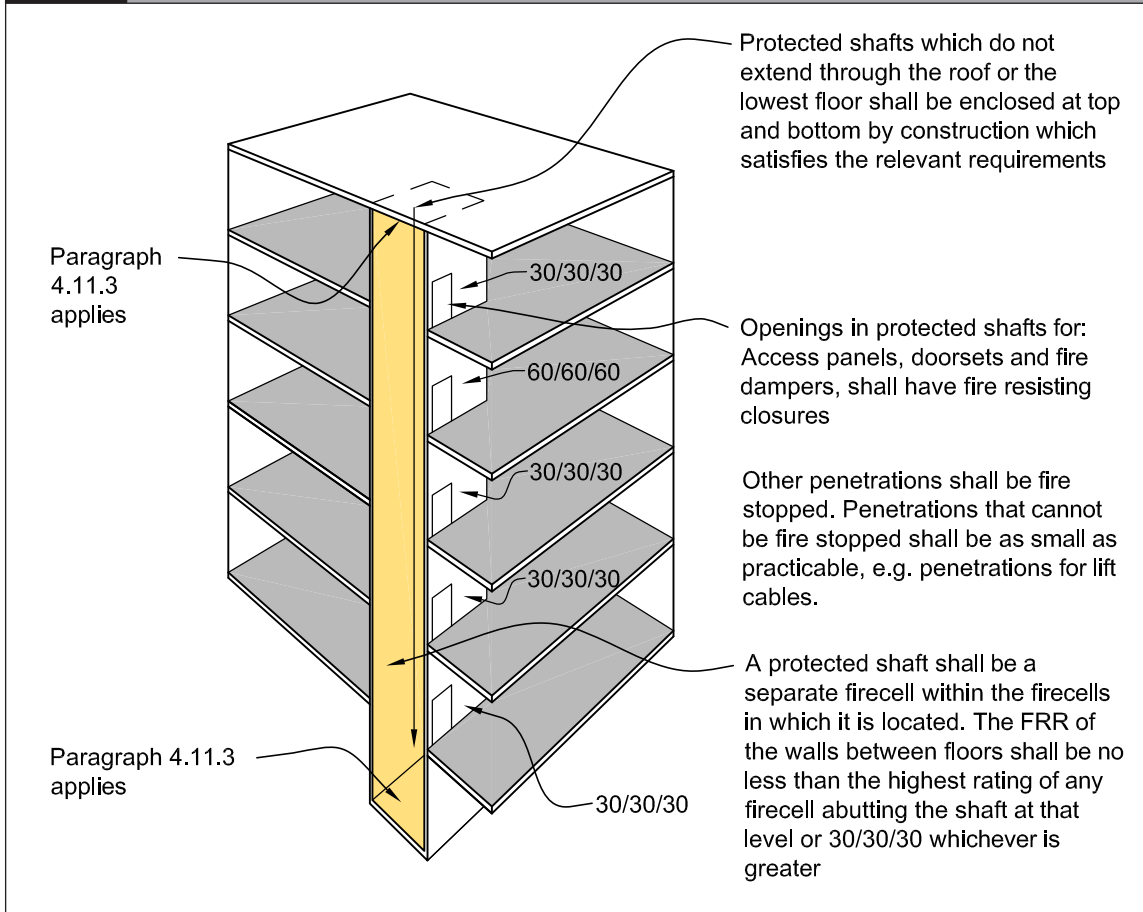

4.12 Long corridor subdivision

4.12.1 Long corridors shall be subdivided by *smoke separations* and *smoke control doors* (see Figure 4.7) which shall be evenly spaced along the corridor and no further apart than:

- a) 40 m within *open paths*, or
- b) 80 m within *safe paths*.

These lengths may be increased by 50% if the *building* is sprinklered.

Comment:

The *smoke control doors* are to swing both ways if required by Paragraph 3.15.3.

Hold-open devices are required by Paragraph 3.15.9 to allow the doors to remain open during normal use of the *building*, but to close automatically in the event of a *fire*.

4.13 Floors

4.13.1 Floors in *buildings* shall be *fire separations* (see Figure 4.6) except if either of the following conditions are satisfied:

- a) The floor is an *intermediate floor* within a *firecell* (see Paragraph 4.13.4 for the *FRR* requirement), or
- b) The floor is the lowest floor above an unoccupied subfloor space and complies with Paragraph 4.14.1.

4.13.2 Floors only need to be rated from the underside. The *FRR* of a floor shall be that rating applicable to the *firecell* directly below the floor (see Figure 4.6).

Intermediate floors

4.13.3 THIS PARAGRAPH DELIBERATELY LEFT BLANK

Figure 4.7 Long corridor subdivision
Paragraphs 4.12.1 and 4.16.8

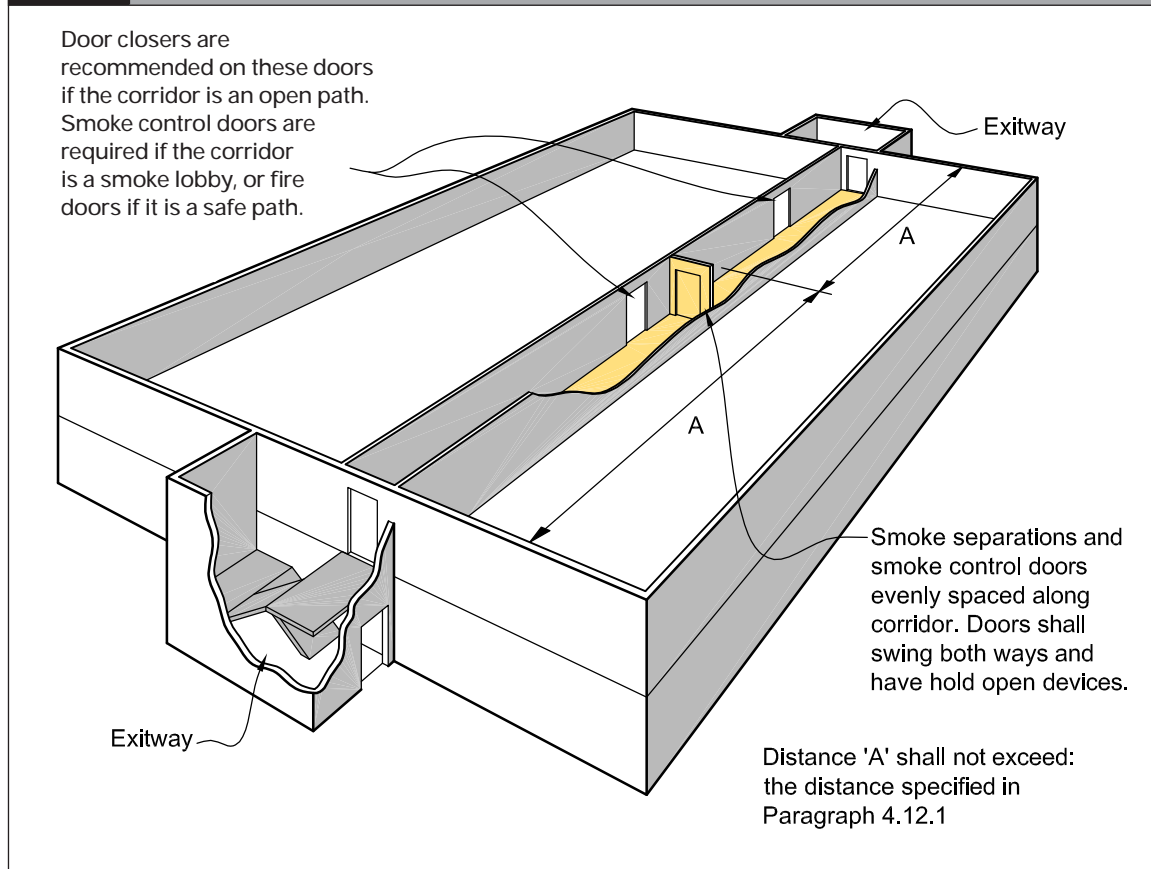

4.13.4 *Intermediate floors* and stairs used as access and their supporting *primary elements* within the *firecell* shall have *FRRs* of at least 30 minutes.

4.13.5 *Intermediate floors* shall satisfy the following conditions:

- a) There is only one *intermediate floor*, and
- b) The total *occupant load* on the *intermediate floor* is no greater than 100, and
- c) The total area of the *intermediate floor* is no greater than that specified in Paragraph 4.13.6.

4.13.6 The maximum total area of the *intermediate floor* within the *firecell* shall be the lowest of:

- a) 20% of the area of the *firecell* floor not including the area of the *intermediate floor* if the *intermediate floor* is enclosed or partitioned and does not have an alarm system with smoke detection installed throughout the *firecell*, or
- b) 40% of the area of the *firecell* floor not including the area of the *intermediate floor* if the *intermediate floor* is either:
 - i) completely open, or
 - ii) if enclosed or partitioned, a Type 4 system is installed, or
- c) The area that allows up to 100 occupants on the *intermediate floor* based upon the occupant density of the space as calculated in accordance with Paragraph 1.4.

Comment:

The smaller (20%) floor area is a concession for spaces which are mainly used for storage with a low occupant density.

Firecells containing *intermediate floors* require the same *fire* safety precautions as single level *firecells* with the same total *occupant load* and *escape heights*. Examples of *buildings* with *intermediate floors* which could meet these requirements are: churches, halls, small *theatres*, gymnasiums and shops.

As 100 occupants is the maximum *occupant load* of an *intermediate floor* (depending on the activity on that floor), the area of that floor cannot exceed that necessary to accommodate 100 people.

4.13.7 THIS PARAGRAPH DELIBERATELY LEFT BLANK

Flytowers, walkways and similar structures

4.13.8 Intermittently occupied structures such as walkways, ladders, flytowers and gantries that are not used by the public are not required to be *fire* rated provided that no more than 10 people have access concurrently.

Basement floors

4.13.9 *Basement firecells* shall be separated from one another, and from the lowest *firecell* above ground level, by *fire separations* having *FRRs* in accordance with Paragraph 2.3.

4.14 Subfloor spaces

4.14.1 In *buildings* with an unoccupied subfloor space between the ground and lowest floor (see Figure 4.8), the floor shall have an *FRR* in accordance with Paragraph 2.3, except that no *FRR* is required if the following conditions are satisfied:

- a) Vertical *fire separations* and *external walls* extend down to ground level and enclose the space, and
- b) Access is available only for intermittent servicing of plumbing, drainage or other static services, and
- c) The space is not used for storage and does not contain any installation such as machinery or heating appliances which could create a *fire hazard*, except when *fire separated* from the rest of the subfloor space.

4.15 Concealed spaces

4.15.1 The spread of *fire* in *concealed spaces* and cavities shall be avoided by ensuring that extensive voids do not pass from one *firecell* to another and by blocking off smaller voids with *cavity barriers*, or where appropriate, by using *fire stops*. See Paragraph 4.4.

Comment:

Enclosing spaces with *fire* and *smoke separations* is one of the methods of controlling *fire* and smoke spread for satisfying this Acceptable Solution. However, if *fire separations* are internal walls, it is essential that those walls enclose any upper *concealed space* by extending beyond the ceiling to the floor or roof above.

Smoke detection and alarm systems are often relied on to provide *building* occupants, particularly sleeping *risk groups*, with early warning in the event of *fire*. However, where the smoke detectors are located only in the *occupied spaces*, smoke and *fire* can travel unobserved in upper *concealed spaces* that have not been *fire* or *smoke separated*. See Paragraph 4.15.2 for subdivision requirements for *concealed spaces*.

Concealed spaces within firecells

4.15.2 An upper *concealed space* may be used as an air handling plenum (see Figure 4.9) if the following requirements are satisfied:

- a) The upper *concealed space* does not extend into another *firecell*, and
- b) The ceiling and its supports and surfaces within the *concealed space* are *non-combustible*, and
- c) Electrical wiring is supported clear of the ceiling members and other equipment, and
- d) Any material used, such as pipe insulation or acoustic insulation, complies with the requirements of Table 4.1, and
- e) Where the air handling plenum is used as an air supply path, a Type 4 system is installed with detectors in all return air ducts, and
- f) Where the air handling plenum is used as an air supply path, detector activation also causes the ventilation system to switch from circulation to extract as required by Paragraph 4.18.2.

Figure 4.8 Subfloor spaces
Paragraph 4.14.1

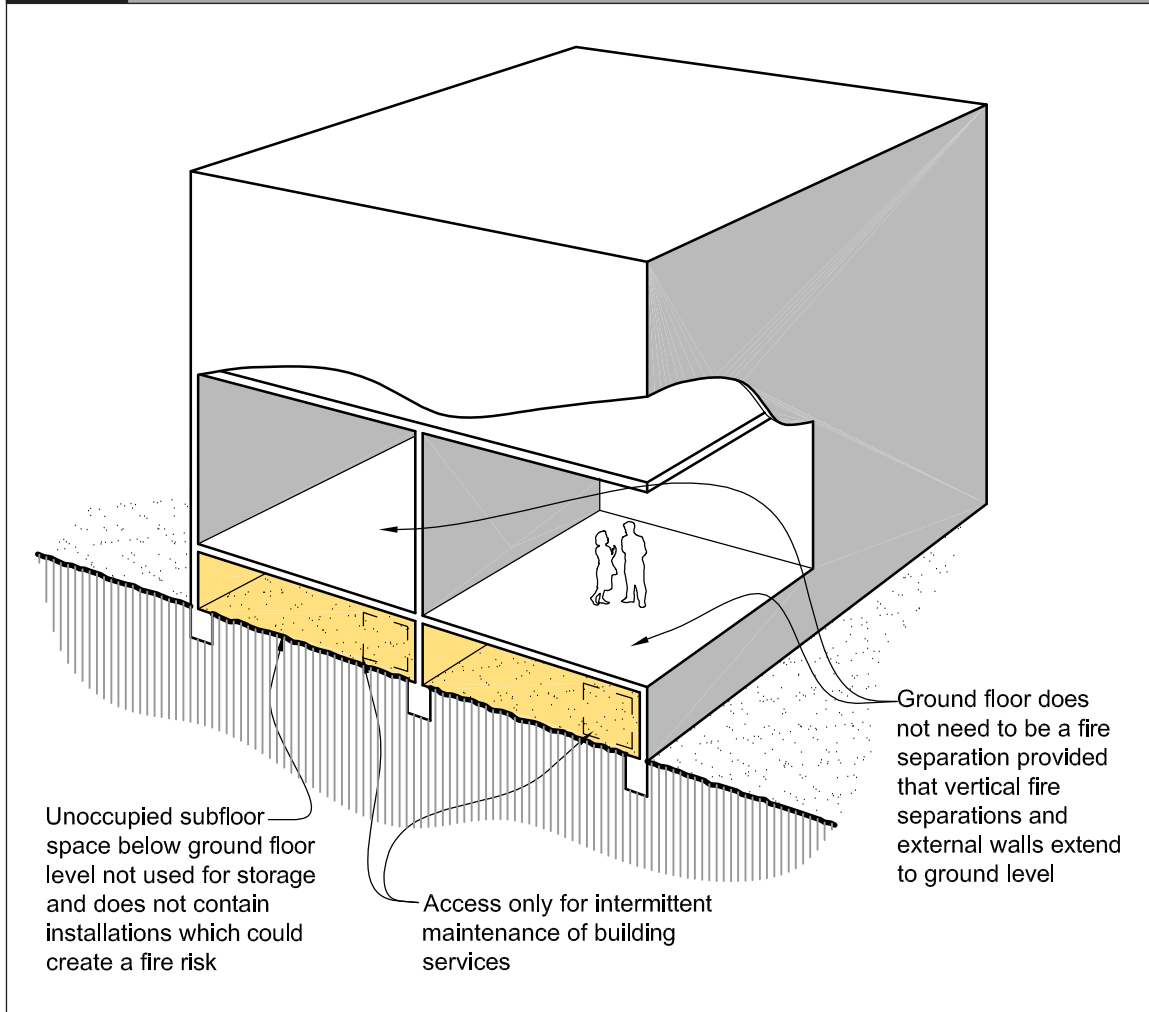

Comment:

Paragraph 4.15.2 e) and f) do not apply when the air handling plenum is used as an air exhaust path with a separate, ducted air supply to the *firecell*.

Cavity barriers in walls and floors

4.15.3 Any *concealed space* which may be a path for *fire spread* within internal walls or floors which are *fire separations*, or within *external walls*, shall have *cavity barriers* or be *fire stopped* (see Paragraph 4.4) at all common junctions (see Figures 4.10 and 4.11).

Comment:

In multi-storey *buildings*, it is essential to avoid rapid vertical *fire spread* between floors. Paragraph 5.7.14 deals with the particular requirement for *external walls*, where 'curtain wall' type *construction* may create extensive cavities.

Figure 4.9 Concealed spaces within firecells
Paragraph 4.15.2

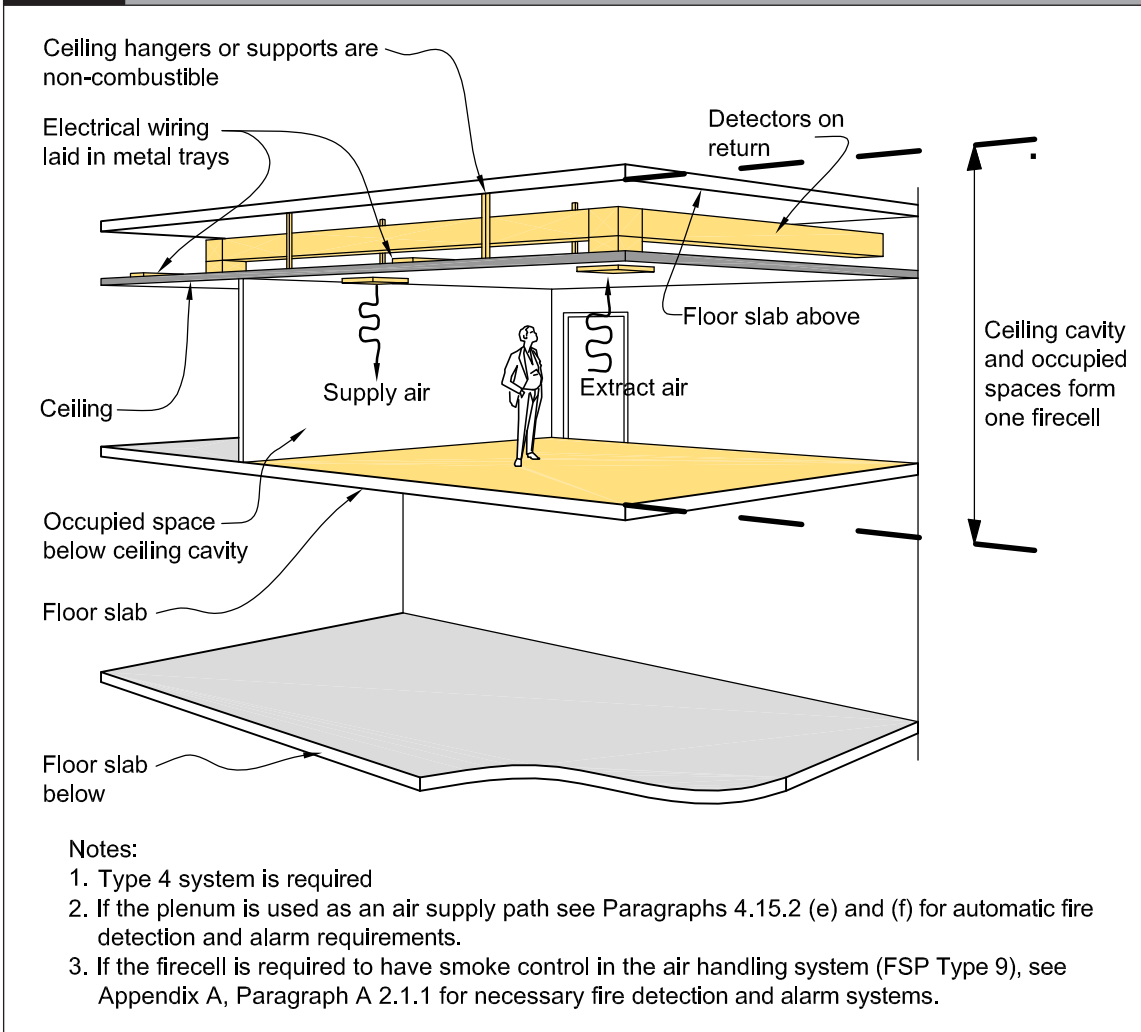

Exceptions to cavity barrier requirements

4.15.4 *Cavity barriers* are not required in the following circumstances:

- a) Below a floor next to the ground if the *concealed space* is:
 - i) Less than 1.0 m in height, or
 - ii) Not normally accessed and has no openings through which litter can accumulate, or
- b) If the *concealed space* results from the over-cladding of an existing *external wall* or roof, provided that the existing cladding is *non-combustible*, or

- c) In a wall or roof panel system encapsulated with a material having a *Group Number* of no greater than 2.

Comment:

See Verification Method C/VM2 Appendix A for the method of assigning *Group Numbers* to materials.

Figure 4.10 Curtain wall
Paragraphs 4.15.3 and 5.7.14

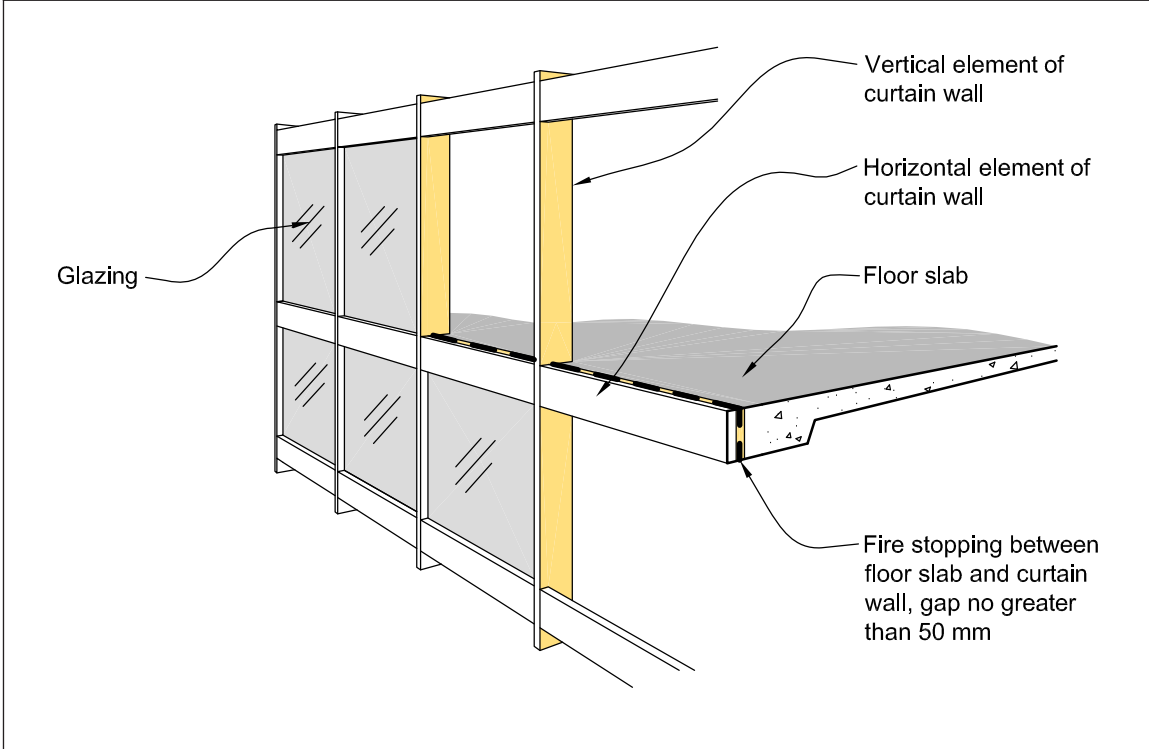
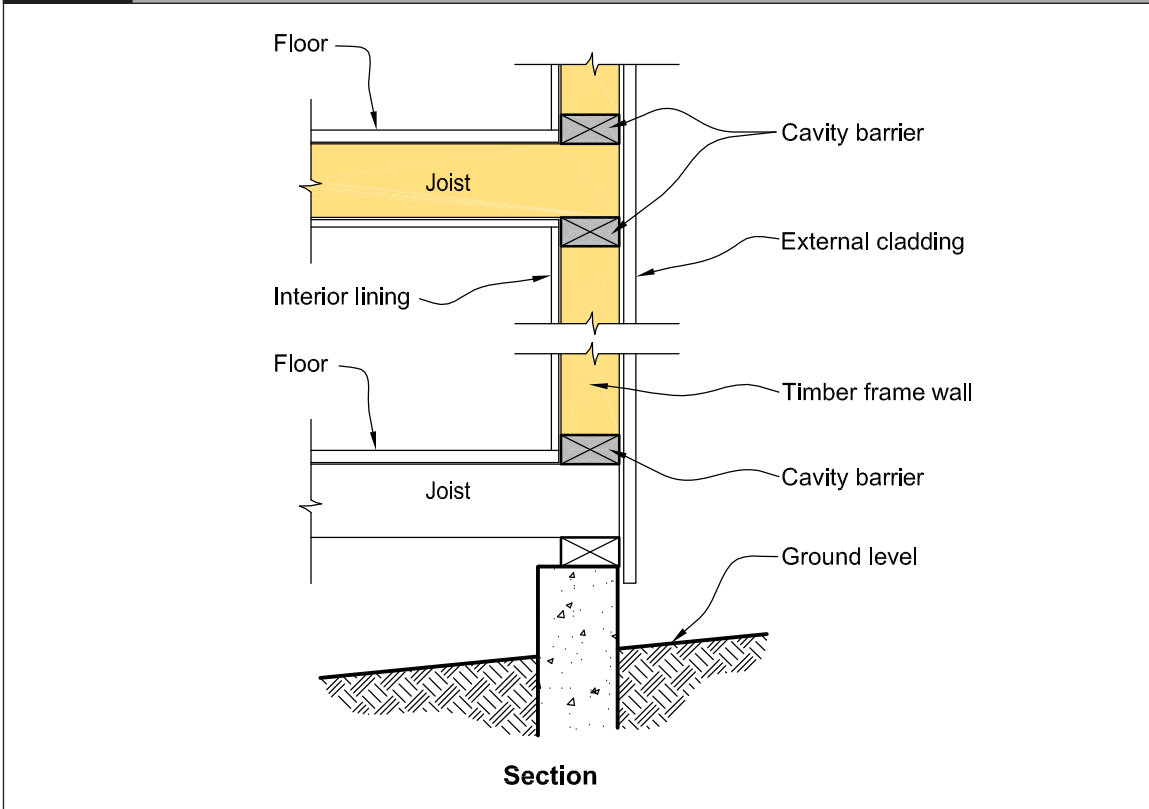

Figure 4.11 Hollow construction
Paragraph 4.15.3



Cavity barrier construction

4.15.5 Cavity barriers shall:

- a) Not reduce the *FRR* required for the element within which they are installed
- b) Where practical, be tightly fitted and mechanically fixed to rigid *construction* but, if this is not possible, gaps shall be *fire stopped*, and
- c) Be fixed in a way that avoids impairment of their *fire separation* function as a result of:
 - i) *building* movement due to subsidence, shrinkage or thermal change, or
 - ii) collapse or failure of their components or fixings, or of abutting materials and any *penetrations* during a *fire*.

Restriction of roof and ceiling space areas in unsprinklered firecells

4.15.6 Within unsprinklered *firecells*, roof space and ceiling space areas shall be subdivided by *fire separations* to prevent the hidden spread of *fire*. Any space between ceilings and roofs or floors above shall not exceed 400 m² in area, measured at ceiling level, and 30 m in length or width. This provision does not apply where the ceiling space is a separate *firecell*.

4.15.7 The *fire separations* used for subdivision shall have an *FRR* in accordance with Paragraph 2.3 and shall extend from the ceiling to the underside of the external roof cladding or floor above. Any gaps shall be *fire stopped* as specified in Paragraph 4.4.

4.15.8 If openings in the *fire separations* are required for service access or for any other reason, they shall be fitted with *fire resisting closures*. Gaps around service *penetrations* shall be *fire stopped*.

4.16 Closures in fire and smoke separations

Introduction

4.16.1 If activities within a *building* require openings in *fire* or *smoke separations* (eg, for the passage of people, goods or services or for light), closures to those openings shall have the *fire* resistance and smoke control performance as follows:

- a) An *FRR* of -/60/30 sm if unsprinklered, except as permitted by Paragraph 4.16.12, or
- b) An *FRR* of -/30/- sm if sprinklered.

Comment:

sm indicates that the closure performs as part of a *smoke separation*. See Paragraph 4.16.2 b) for doors in *smoke separations* and Paragraph 4.16.10 for access panels.

4.16.2 Doorsets which are required to be:

- a) *Fire doors* shall comply with Appendix C C6.1.1
- b) *Smoke control doors* shall, except as allowed by Paragraph 4.16.3, comply with Appendix C C6.1.2, and

Comment:

Smoke seals may be of the brush type and do not need to incorporate intumescent material. However, intumescent seals may be required if the door is also a *fire door*.

- c) *Fire doors* with smoke control capability shall comply with both a) and b) above.

4.16.3 *Doorsets* installed in *fire separations* between *firecells* and vertical *safe paths* or *protected shafts* shall have smoke seals on all edges, except that smoke seals may be omitted:

- a) At the sill of *doorsets*, and
- b) For lifts, if either:
 - i) the *firecell* is sprinklered and has an automatic smoke detection system, or
 - ii) a *smokecell* is placed between the doors and the rest of the *firecell*, other than when the lift shaft is permitted to be in the vertical *safe path*.

Fire door and smoke control door installation

4.16.4 *Fire doors* and *smoke control doors* shall be installed in accordance with Paragraph 3.15.

Doorset markings

4.16.5 Doorsets shall be clearly marked to show their *FRR* and, if required, to show their smoke-stopping capability. Other signage requirements shall be as specified in Paragraph 3.16.

4.16.6 Markings and labelling shall, in all other respects, comply with NZS 4520.

Glazing in doors

4.16.7 Glazing in *fire doors* and *smoke control doors* shall comply with Paragraph 4.2.

Smoke control doors

4.16.8 *Smoke control doors* complying with Paragraphs 4.16.2 to 4.16.7 shall be provided:

- a) At smoke control separations in vertical *safe paths*
- b) Where a corridor or an *escape route* passes through a *smoke separation* (see Figure 4.12 and for long corridors Figure 4.7), and
- c) Between an *open path* and a *smoke lobby* (see Figures 4.13 and 4.14).

Figure 4.12 Smoke control doors
Paragraph 4.16.8

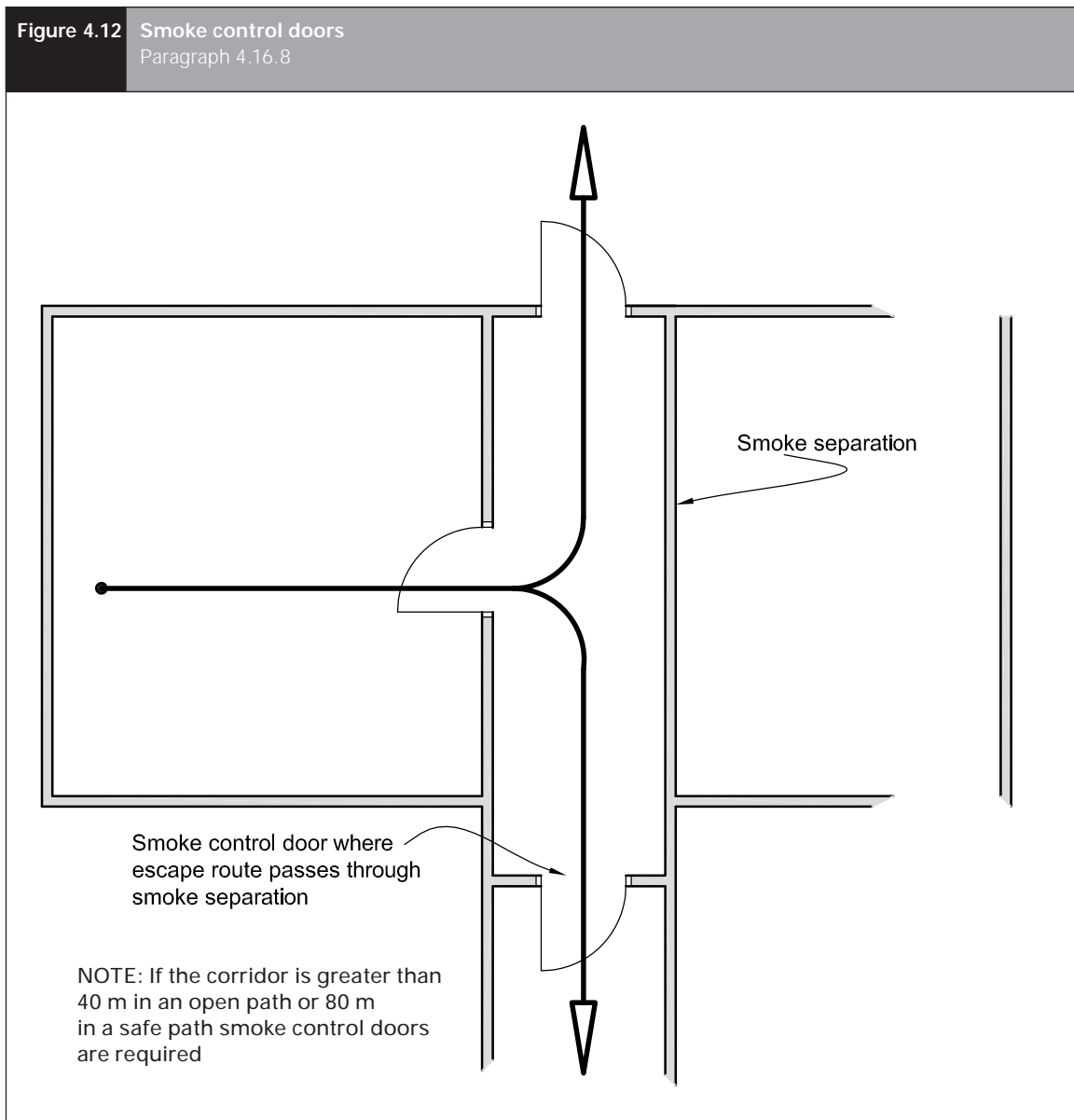
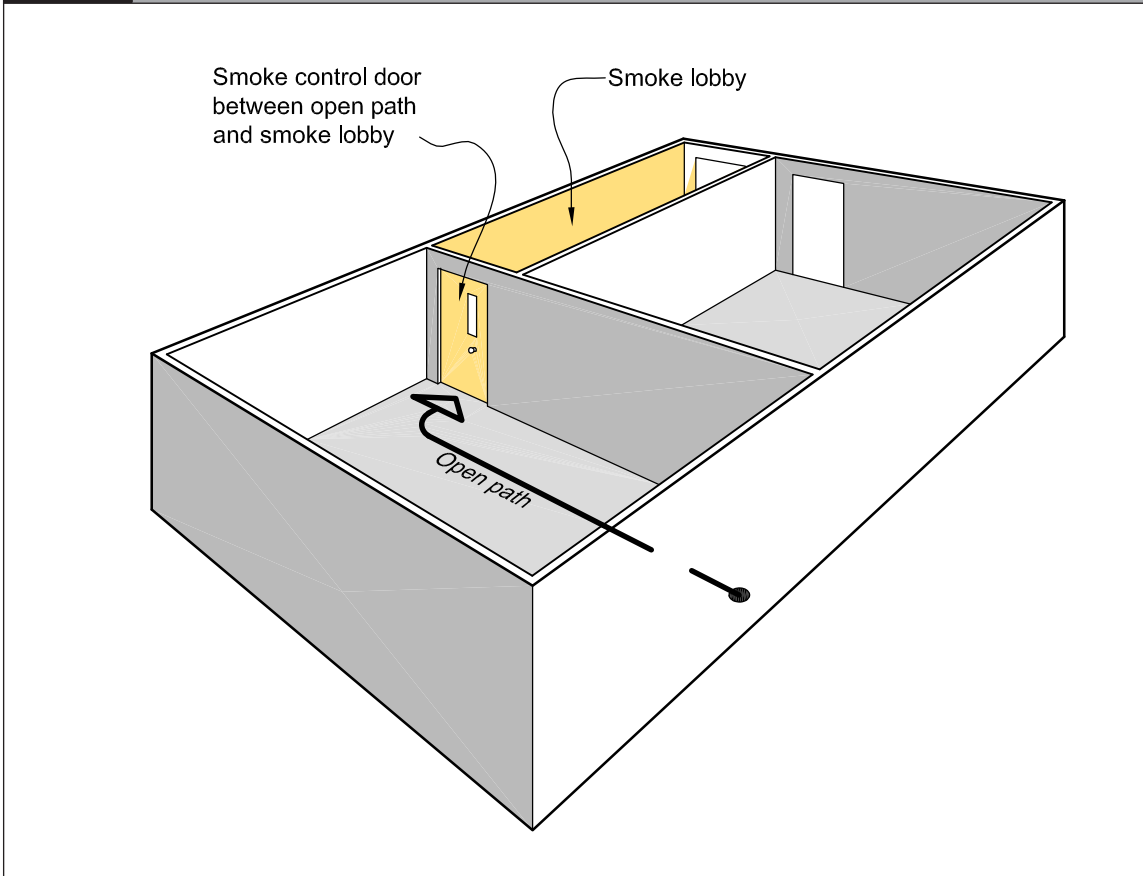

Figure 4.13 Smoke control doors on smoke lobbies
Paragraph 4.16.8



Fire doors

4.16.9 Fire doors shall be provided:

- a) Between an *open path* and a *safe path* (see Figures 3.15 and 4.15)
- b) Between a *smoke lobby* and a *safe path* (see Figure 4.14)
- c) Where the *escape route* passes through a *fire separation* (see Figure 4.15) or into an adjoining *building* (see Figure 3.10)
- d) Where the *escape route* passes through a *fire separation* which isolates the *safe path* from levels below the *final exit* (see Figure 4.16), and
- e) In *fire separations* between vertical and horizontal portions of internal *safe paths*.

Comment:

Doors at *final exits* are not required to be *fire rated*. *Fire doors* in *exitways* protect occupants from the effects of *fire* during evacuation. *Fire doors* at the head of stairs to *basements*, as required by Paragraph 4.9.3, isolate the *basement* section of the vertical *safe path*.

Figure 4.14 Fire doors and smoke control doors
Paragraphs 4.16.8 and 4.16.9

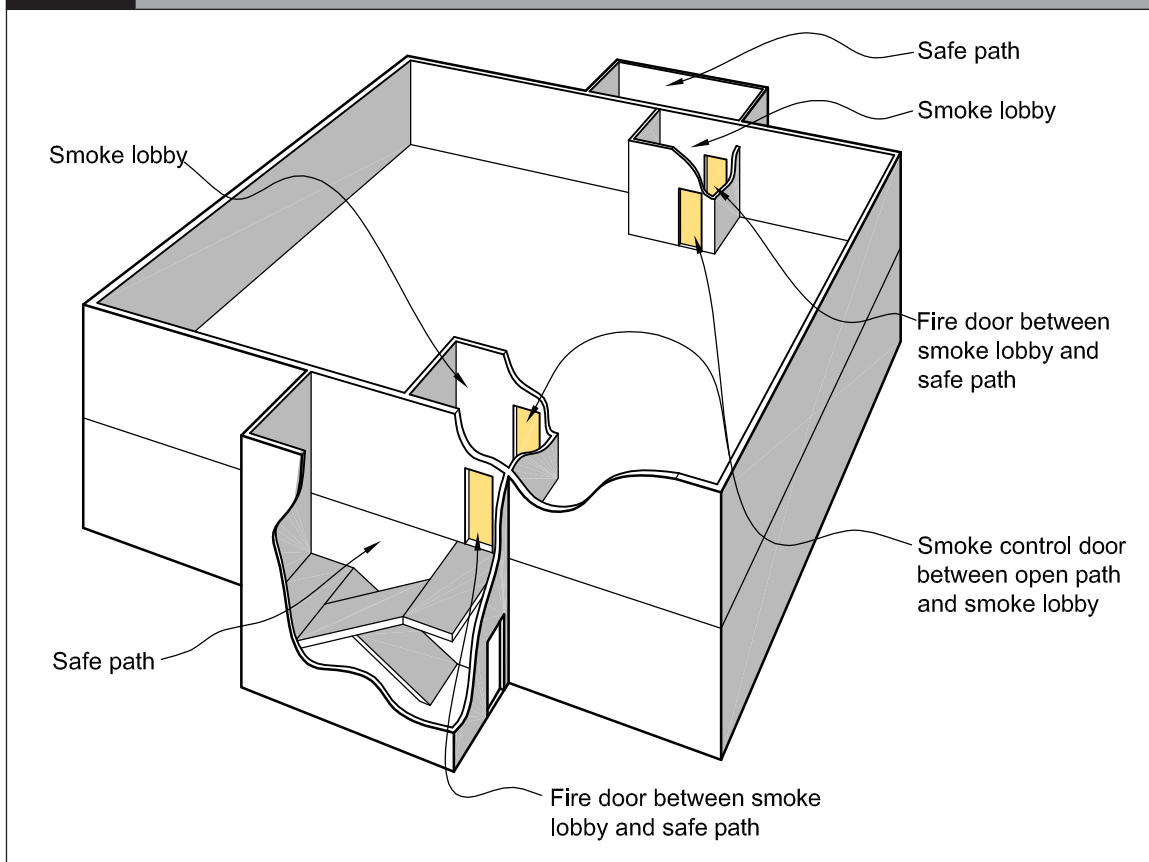

Figure 4.15 Fire doors
Paragraph 4.16.9

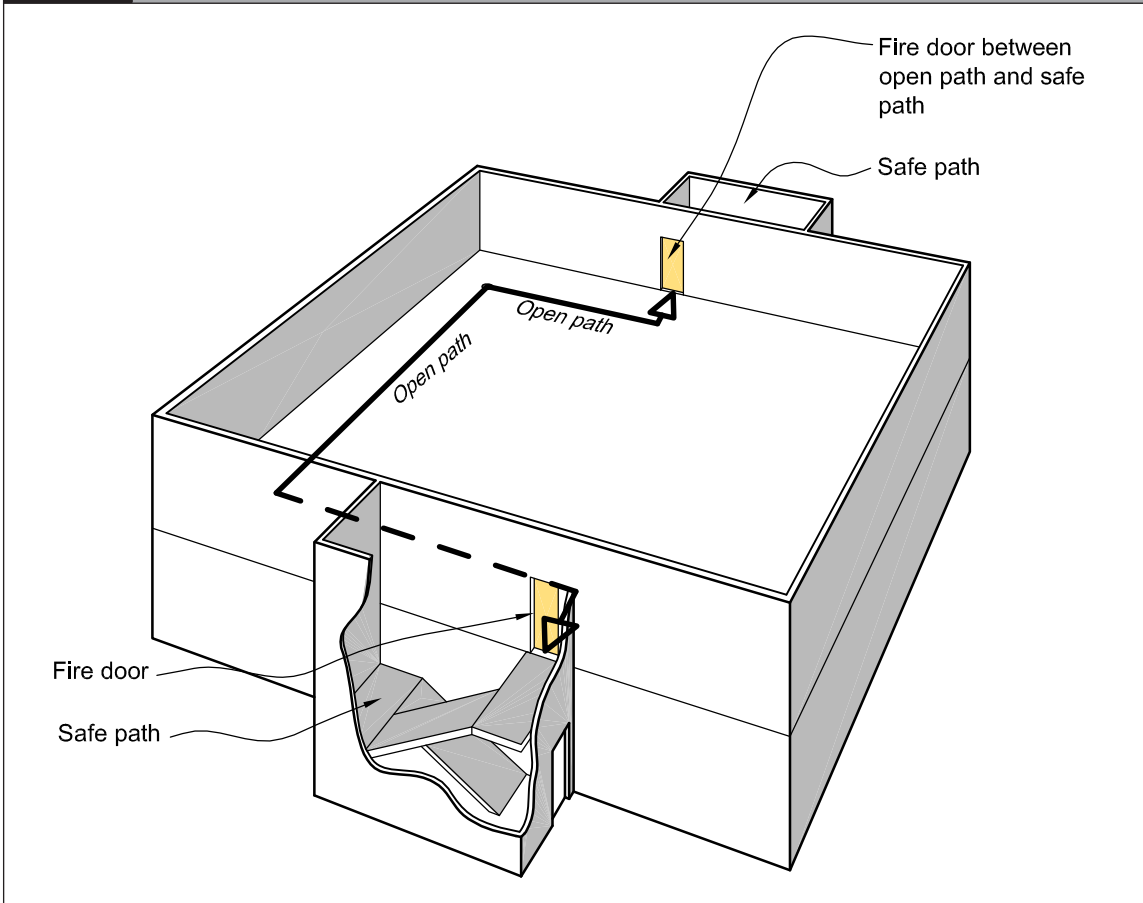
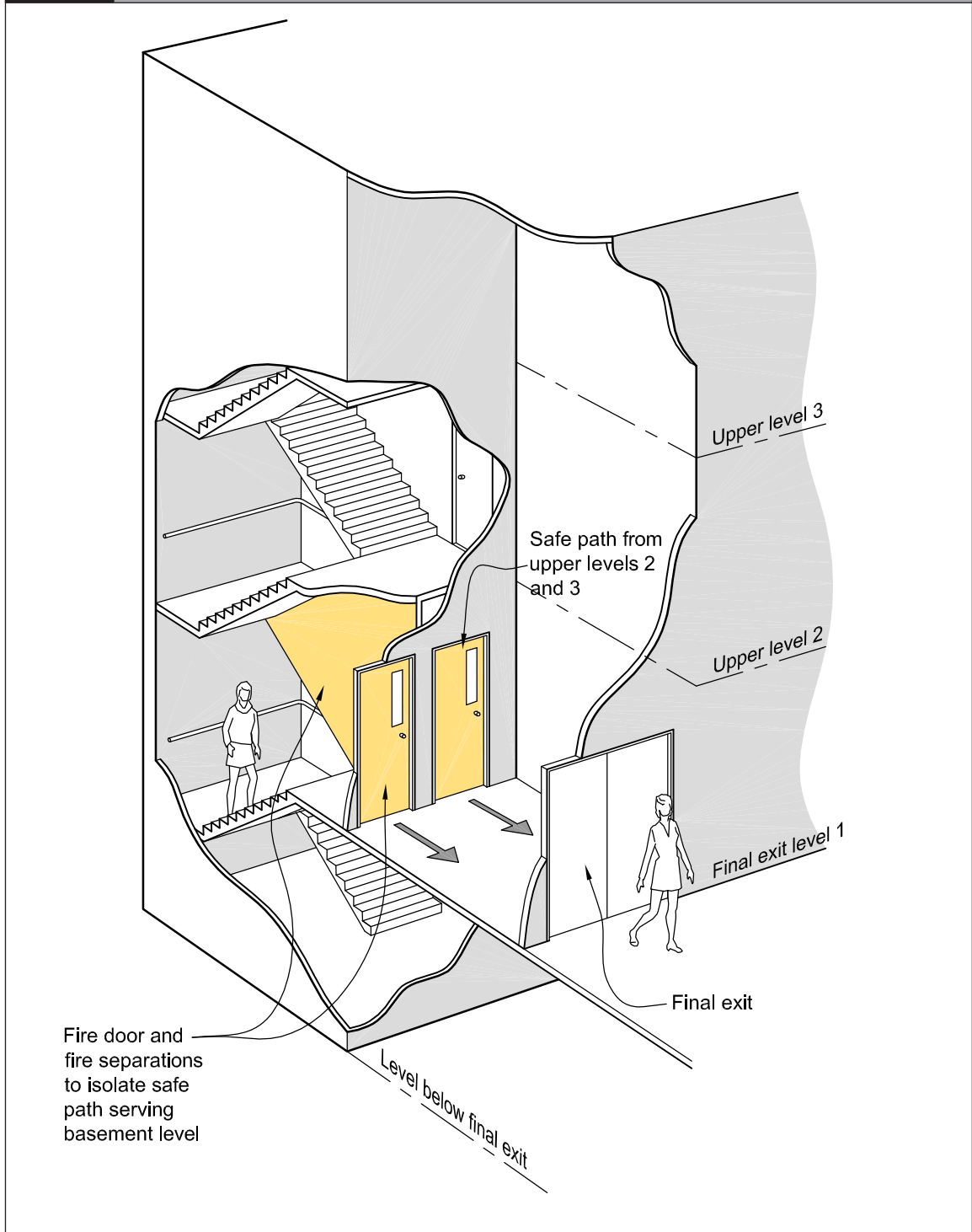

Figure 4.16 Fire doors to separate floors above and below final exit level
Paragraph 4.16.9 d)



Protected shaft access panels

4.16.10 Access panels to *protected shafts* shall have the *fire* resistance performance as required by Paragraph 4.16.1 and shall:

- a) Be capable of being opened only with a special tool, and
- b) If smoke seals cannot be provided, be tight-fitting with a maximum total gap of 8mm around the panel (see Figure 4.17).

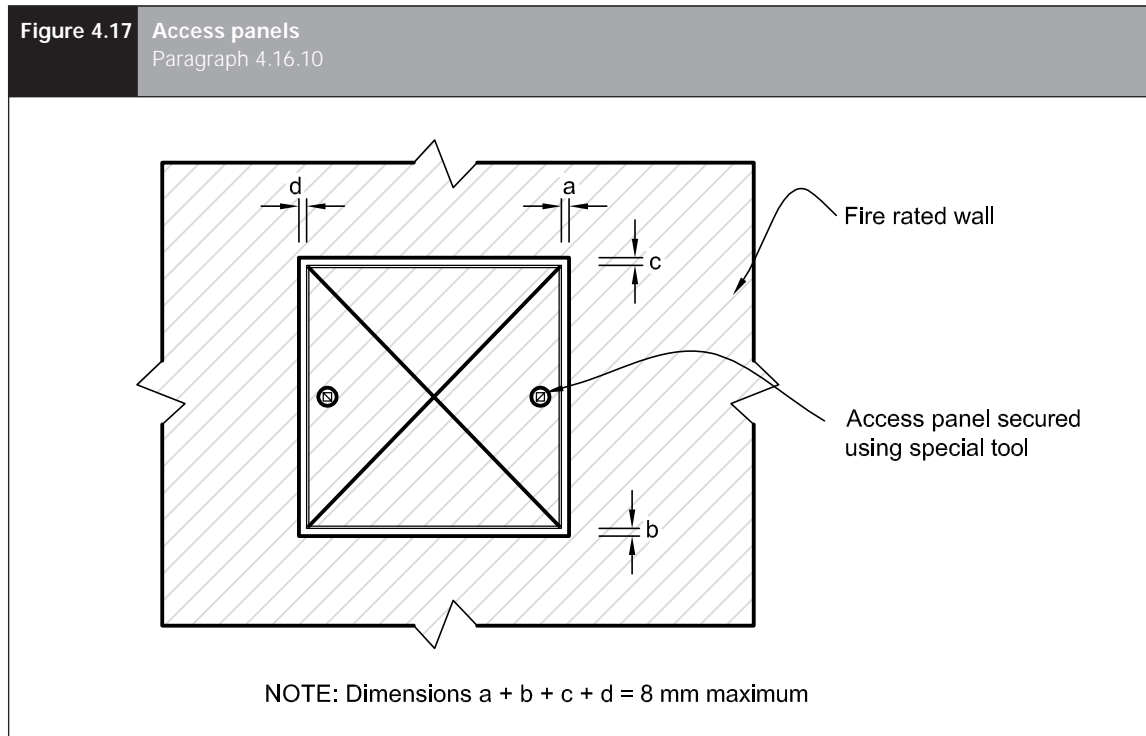

Lift landing doors

4.16.11 Other than where Paragraph 3.10.3 for a passenger lift within a vertical *safe path* applies, *doorsets* for lift landing doors opening into lift shafts which are *protected shafts* shall be *fire doors* complying with Paragraphs 4.16.1 to 4.16.3. Lift landing doors need not be *fire* rated from the shaft side.

Fire dampers

4.16.12 Unless fully enclosed by *construction* with an *FRR* of no less than required for the *fire separation*, any air duct passing through a *fire separation* shall be equipped with a *fire damper* which, in the event of duct failure or collapse due to *fire*, closes the opening through the separation. The *fire damper* shall have an *FRR* of no less than that of the *fire separation*, except that a *fire damper* is not required to have an *insulation* rating. The *fire damper* shall be capable of being readily accessed for servicing.

Comment:

Fire dampers are not effective in stopping smoke and are not required in *smoke separations*. Smoke control in ducts is effected by smoke control devices in the air handling system (see Paragraph 4.18).

Fire shutters

4.16.13 If a floor has a service opening (eg, for stairs, a conveyor, forklift access or similar installation) which is not used as part of an *escape route* and which is fitted with a *fire shutter*, the floor may be treated as a *fire separation*.

4.16.14 The *fire shutter* shall be automatically activated by a signal from a smoke detector.

4.16.15 A *fire shutter* shall include a device to retard the rate of closing to no more than 150 mm per second.

4.17 Interior surface finishes, floor coverings and suspended flexible fabrics

Surface finish requirements for walls, ceilings, ducts and insulation

4.17.1 *Surface finish* requirements shall be as specified in Table 4.1.

Table 4.1 Surface finishes						
Column 1	Column 2	Column 3	Column 4	Column 5	Column 6	Column 7
	<i>Exitways</i> All <i>occupied spaces</i> in importance level 4 <i>buildings</i>	Crowd spaces: wall linings	Crowd spaces: ceiling linings	All other <i>occupied spaces</i> : wall and ceiling linings	Ducts for <i>HVAC</i> systems – internal surfaces	Ducts for <i>HVAC</i> systems – external surfaces Acoustic treatment and pipe insulation within air handling plenum
	Maximum permitted <i>Group Number</i>					
Unsprinklered	1S	2S	2S	3	1S	3
Sprinklered	2	3	2	3	2	3

Comment:

The method for assigning the *Group Number* to a material and for establishing the smoke production rate is specified in Verification Method C/VM2 Appendix A.

Foamed plastics and exposed combustible insulating materials

4.17.2 If *foamed plastics building materials* or exposed *combustible insulating materials* form part of a wall, ceiling or roof system, the completed system shall achieve a *Group Number* as specified in Table 4.1 and the *foamed plastics* shall comply with the flame propagation criteria as specified in AS 1366 for the material being used. This requirement does not apply to *building elements* listed in Paragraph 4.17.6.

Comment:

The completed system may or may not include a surface lining product enclosing any insulation material from any adjacent *occupied space*. If a surface lining is not included, then the *foamed plastics* or *combustible insulating materials* when tested alone shall achieve a *Group Number* of 3, otherwise a surface lining is also required such that the completed system achieves a *Group Number* of 3. This paragraph applies to *foamed plastics building materials* whether exposed to view from the *occupied space* or enclosed.

Flooring

4.17.3 Flooring shall be either *non-combustible* or, when tested to ISO 9239-1, shall have a critical radiant flux of not less than that specified in Table 4.2.

4.17.4 Paragraph 4.17.3 shall apply to flexible finishes such as carpets, vinyl sheet or tiles, and to finished or unfinished floor surfaces.

Area of building	Critical radiant flux requirements for flooring	
	Buildings not protected with a fire sprinkler system	Buildings protected with a fire sprinkler system
Exitways in all buildings	2.2 kW/m ²	2.2 kW/m ²
Firecells accommodating more than 50 people	2.2 kW/m ²	1.2 kW/m ²
All other occupied spaces	1.2 kW/m ²	1.2 kW/m ²

Wood and wood products in floors

4.17.5 In any *firecell* which has a *firecell* below, the flooring may be of wood products (wood products include boards manufactured from wood fibres or chips bound by an adhesive) provided it has either a thickness of no less than 20 mm, or the floor assembly has an *FRR* of -/30/30 when exposed to *fire* from the flooring side.

Exceptions to surface finish requirements

4.17.6 *Surface finish* requirements do not apply to:

- Small areas of non-conforming product within a *firecell* with a total aggregate surface area not more than 5.0 m²
- Electrical switches, outlets, cover plates and similar small discontinuous areas
- Pipes and cables used to distribute power or services
- Handrails* and general decorative trim such as architraves, skirtings and window components, including reveals
- Damp-proof courses*, seals, caulking, flashings, thermal breaks and ground moisture barriers
- Timber joinery and structural timber *building elements constructed* from solid wood, glulam or laminated veneer lumber. This includes heavy timber columns, beams, portals and shear walls not more than 3.0 m wide, but does not include exposed timber panels or permanent formwork on the underside of floor/ceiling systems
- Individual *doorsets*
- Continuous areas of permanently installed openable wall partitions having a surface area of not more than 25% of the divided room floor area or 5.0 m², whichever is less, and
- Marae buildings* using traditional Māori *construction* materials (eg, tukutuku and toetoe panels).

Comment:

Note that if this exception is applied, exit widths and *travel distances* for *marae buildings* as in i) must comply with the requirements of Paragraphs 3.3.2 j) and 3.4.2 e) respectively.

Educational buildings

Errata 1
Feb 2013

4.17.7 Unsprinklered *firecells* containing classrooms, passageways and corridors of educational *buildings* need not comply with Table 4.1 (column 3) provided the following conditions are satisfied:

- a) The *occupant load* is less than 250, and
- b) The *firecells* are at ground floor level and are served by at least two *exitways* or *final exits*, and
- c) The material *Group Number* (assigned as specified in C/VM2 Appendix A) is no more than 2–S for surfaces 1.2 m or more above floor level, and
- d) The material *Group Number* is no more than 3 for surfaces less than 1.2 m above floor level.

Errata 1
Feb 2013

Comment:

This provision allows for materials such as painted particleboard to be used from floor level to a height of 1.2 m where rapid escape is possible.

Suspended flexible fabrics

4.17.8 When tested to AS 1530 Part 2, suspended flexible fabrics shall, within all *occupied spaces* including *exitways*:

- a) Have a *flammability index* of no greater than 12, and
- b) When used as underlay to roofing or exterior cladding that is exposed to view, have a *flammability index* of no greater than 5.

Membrane structures

4.17.9 The fabric of structures such as tents, marquees or canopies shall be tested to AS 1530 Part 2 and shall achieve a *flammability index* of no greater than 12.

4.17.10 The requirements for membrane structures need not apply to small *occupant loads* such as camping tents and horticultural applications.

Air ducts

4.17.11 Where air ducts are contained wholly within a *protected shaft*, provided the shaft does not also contain lifts, only the interior *surface finish* of the air duct is required to comply with Table 4.1.

4.18 Building services plant

Automatic activation

4.18.1 When any smoke detection system is activated, it shall automatically turn off all air-conditioning and mechanical ventilation plant which is not required or designed for *fire* safety.

Air handling systems

4.18.2 Where smoke control in air handling systems is required to prevent the recirculation of smoke through an air handling system to other *firecells* in a *building*, these systems shall be as specified in Appendix A A2.1.

Part 5: Control of external fire spread

CONTENTS

- 5.1 Fire separation for buildings with more than one title
- 5.2 Horizontal fire spread from external walls
- 5.3 FRRs of external walls
- 5.4 Small openings and fire resisting glazing
- 5.5 Table method for external walls
- 5.6 Horizontal fire spread from roofs and open sided buildings
- 5.7 Vertical fire spread
- 5.8 Exterior surface finishes

5.1 Fire separation for buildings with more than one title

5.1.1 When a *building* is subdivided so that the *building* straddles more than one title, each part of the *building* located on a separate title, other than titles comprising vehicle parking areas, shall be separated from:

- a) The part of the *building* on an adjacent title by *fire separations* having an *FRR* meeting the *property rating* in accordance with Paragraph 2.3, and
- b) Any external area in common, unless Paragraph 5.1.2 applies, by *external walls* complying with Paragraph 5.3 except that, if roofed, the area in common shall be a *firecell* separated from adjacent titles by *fire separations* meeting the *property rating* in accordance with Paragraph 2.3.

Comment:

In a) above, vertical *fire separations* provide *fire* ratings between titles. Floors between titles are also *fire separations* and provide the horizontal separation. See Acceptable Solution C/AS7 for allowances in vehicle parking areas of *buildings* separated into multiple titles.

In b) above, a *notional boundary* is established between the titles, and the permitted *unprotected area* in the *external walls* of both titles is determined with respect to that *notional boundary*. When the area in common is roofed, the danger to life and adjacent property is increased; hence the need for greater precautions.

5.1.2 If a *building* is subdivided (as in Paragraph 5.1.1 a)) and all the titles and any areas in common are sprinklered throughout, the requirements for *fire separations* of Paragraph 5.1.1 b) need not apply. However, the requirements for *fire separation of safe paths* in Paragraphs 4.9.2 and 4.9.3 shall still apply.

5.2 Horizontal fire spread from external walls

Separation

5.2.1 Specific separation requirements for *unprotected areas in external walls* shall be applied in the following circumstances:

- a) If, due to the configuration of a single *building* or the siting of other *buildings* on the same property, *external walls* of adjacent *firecells* are exposed to each other at an angle of less than 90°, and one or both *firecells* contain sleeping risk groups or *exitways*, or
- b) If there are *unprotected areas in external walls* facing a *relevant boundary to other property* at an angle of less than 90°.

Errata 1
Feb 2013

Errata 1
Feb 2013

Comment:

When the vertical planes of two *external walls* of separate *firecells*, or of an *external wall* and a *relevant boundary of other property* (where the wall faces that *boundary*), intersect at an angle of less than 90°, there is potential danger of *fire* spread between *firecells* or to *other property*.

Errata 1
Feb 2013

5.2.2 Protection shall be achieved by using one or more of the following approaches:

- a) Providing a sprinkler system with a water supply complying with NZS 4541 and consisting of two independent supplies, one of which is not dependent on town mains
- b) Distance separation (see Paragraph 5.5)
- c) Limiting *unprotected areas in external walls* (see Paragraph 5.5)
- d) Using *fire resisting glazing* (see Paragraph 5.4).

5.2.3 Where the intersection angle of the *building* and the *relevant boundary* is 90° or greater, there are no requirements and an *unprotected area* of 100% is permitted for the *external wall*.

5.2.4 If a wall or part of a wall is less than 1.0 m from the *relevant boundary*, a combination of small *unprotected areas* and *fire resisting glazing* is permitted as detailed in Paragraph 5.4.

5.2.5 Table 5.2 applies only to the permitted *unprotected area* in *external walls* 1.0 m or more from the *relevant boundary*. This can be combined with the areas of *fire resisting glazing* and small *unprotected areas* in Paragraph 5.4.

5.2.6 Regardless of the method adopted, all parts of an *external wall* other than allowable *unprotected areas* shall have the appropriate *FRR* as specified by the relevant parts of this Acceptable Solution.

Analysis required for all external walls

5.2.7 The analysis shall be done for all *external walls* of the *building* to check the permitted *unprotected area* in each wall.

Notional boundary – firecells on the same property

5.2.8 For *firecells* under common *ownership* in the same *building* or in separate *buildings* on the same property, a *notional boundary* shall be used instead of the *relevant boundary*. In such cases, when applying Tables 5.1, 5.2 and 5.3 the words *relevant boundary* shall be interpreted as *notional boundary*.

5.2.9 Where one or both *firecells* on the same property contain *risk groups* SI, SM, SH or *exitways*, analysis shall be done separately for each *firecell* with respect to the same *notional boundary*.

5.3 FRRs of external walls

5.3.1 *Building elements* which are part of an *external wall* shall be *fire* rated as required by Paragraph 2.3.

5.3.2 Any part of an *external wall* enclosing a *firecell* and not permitted to be an *unprotected area* shall have an *FRR* in accordance with Paragraph 2.3. If the *external wall* is less than 1.0 m from the *relevant boundary* the wall shall be *fire* rated to protect from both directions.

5.3.3 When the *unprotected area* of an *external wall* is permitted to be 100%, but the *primary elements* in the line of that wall are required to be *fire* rated, the rating of those *primary elements* shall be no less than the *life rating* in accordance with Paragraph 2.3.

Errata 1
Feb 2013

Comment:

Primary elements are required to be *fire* rated in *buildings* with an *escape height* of greater than 25 m and where they support, or are an integral part of, other *fire* rated *building elements*.

5.4 Small openings and fire resisting glazing
.....

5.4.1 *External wall construction* shall meet the following requirements:

- a) *Unprotected areas* (referred to as Type A areas) and areas of *fire resisting glazing* (referred to as Type B areas) shall be located to comply with Figure 5.1, and
- b) The remainder of the wall shall be *fire* rated equally for exposure to *fire* on both sides.

Figure 5.1 Method 1 – Permitted small unprotected areas and fire resisting glazing
Paragraphs 5.4.1 and 5.4.4

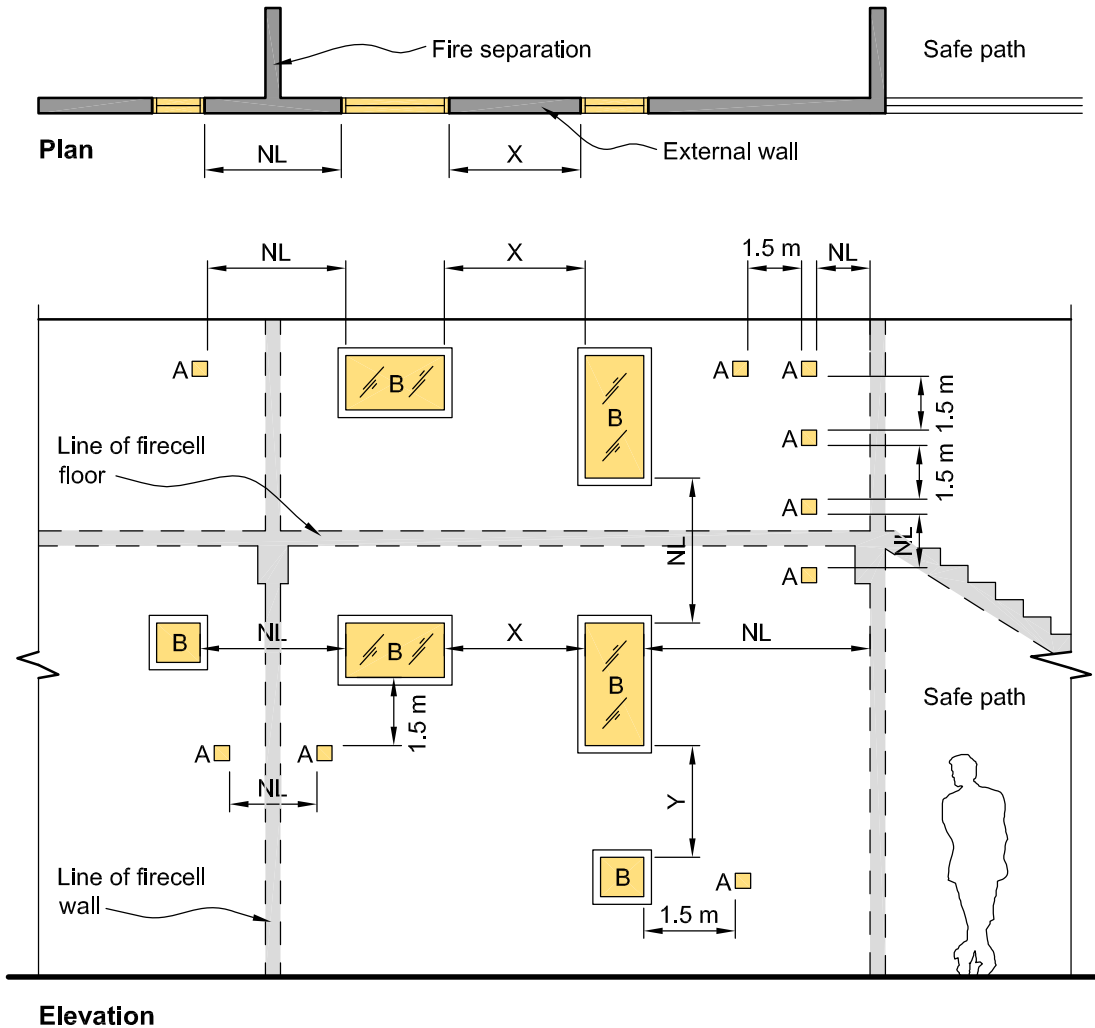

Dimensions shown are minimum distances between Type A unprotected areas and of Type B fire resisting glazing

Legend

- A □ Type A *unprotected areas* of 0.1 m² maximum
- B □ Type B areas of *fire resisting glazing* complying with Table 5.1
- NL No limitation on spacing
- X Spacing to be no less than the greater of the widths of the two Type B areas being considered
- Y Spacing to be no less than the greater of the heights of the two Type B areas being considered

Size and spacing of Type A and Type B areas

5.4.2 Type A areas shall be no greater than 0.1 m². Type B areas shall be no greater than permitted by Table 5.1 according to the distance from the *relevant boundary*.

5.4.3 The *fire resisting glazing* shall be rated for *integrity* and the *FRR* of both the glazing and the *external wall* shall be in accordance with Paragraph 2.3.

5.4.4 There is no limitation on the spacing between adjacent Type A and Type B areas which occur in different *firecells*. Within a *firecell* the following requirements shall apply:

- a) Type A areas shall be no closer, both vertically and horizontally, than 1.5 m to another Type A or to a Type B area
- b) Type B areas shall be no closer to one another, vertically or horizontally, than the dimensions X or Y shown on Figure 5.1, and
- c) Where Type B areas are staggered, rather than being aligned vertically or horizontally, the shortest distance in any direction between adjacent areas shall be no less than the greater of the X and Y measurements.

Table 5.1	Permitted areas of fire resisting glazing	
	Distance to <i>relevant boundary</i> (m)	
Glazing area (m ²)	Unsprinklered	Sprinklered
1.0 or less	0.0	
1.5	0.7	
2.0	0.8	
2.5	0.9	
3.0	0.9	
3.5	1.0	
4.0	1.1	
4.5	1.1	0.0
5.0	1.2	0.0
5.5	1.2	0.1
6.0	1.3	0.1
6.5	1.3	0.1
7.0	1.3	0.2
7.5	1.4	0.2
8.0	1.4	0.3
8.5	1.5	0.3
9.0	1.6	0.3
9.5	1.6	0.4
10.0	1.7	0.4
11.0	1.9	0.5
12.0	2.0	0.6
13.0	2.1	0.6
14.0	2.2	0.7
15.0	2.3	0.8

5.5 Table method for external walls

5.5.1 The table method for *external walls* is a means of satisfying the requirements of this Acceptable Solution for the control of external *fire* spread and shall be applied to *external walls* of *buildings* which are parallel to or angled at less than 90° to the *relevant boundary*. Table 5.2 is split into three parts according to the angle incident between the subject wall and the *relevant boundary*. If the wall is parallel to the *boundary* or the angle is less than 45°, then columns 2 and 3 shall be used (see Figures 5.2 and 5.3).

Figure 5.2 Separation of unprotected areas
Paragraph 5.5.1

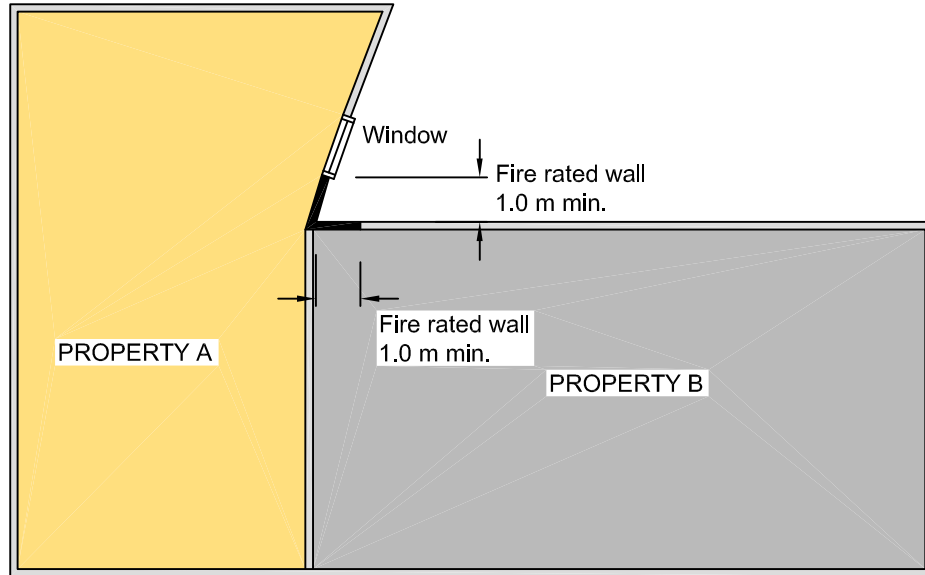

(a) ADJOINING FIRECELLS

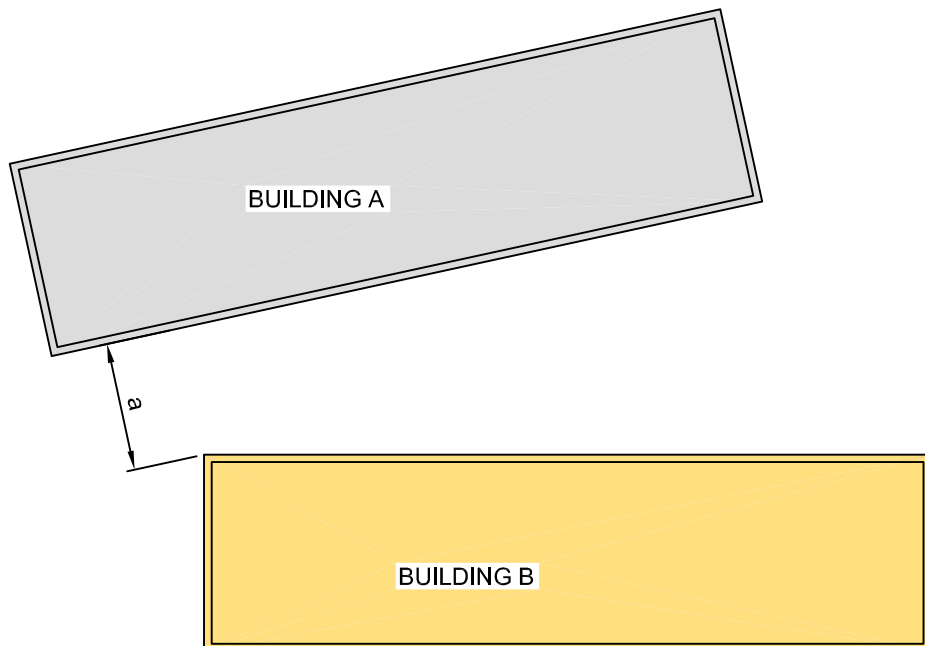

NOTE: a = distance to other building

(b) SEPARATE BUILDINGS

Figure 5.3 Measuring distance to relevant boundary
Tables 5.2 and 5.3 and Paragraph 5.5.1

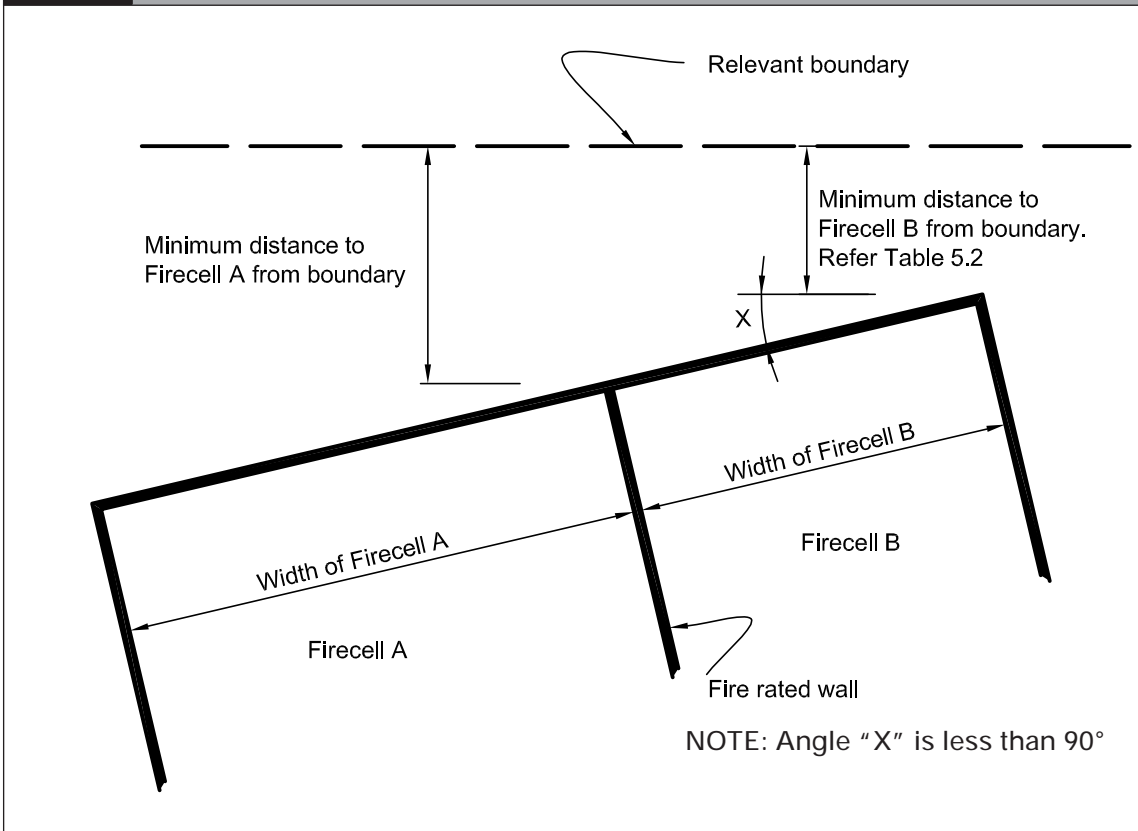

Errata 1
Feb 2013

5.5.2 The table method shall be used to determine the percentage of *unprotected area* in the *external wall* of each *firecell* depending on the distance to the *relevant boundary*.

5.5.3 Table 5.2 can also be used to determine the required distance from the *relevant boundary* where the percentage of *unprotected area* has previously been determined. Select the appropriate percentage (under the rectangle width column) and read the permitted distance to the *relevant boundary* from the left hand column of Table 5.2.

5.5.4 If Table 5.2 does not contain the exact measurements for the *firecell* being considered, use the next highest value for percentage area or next lowest value for *boundary* distance.

5.5.5 The largest individual *unprotected area* in the *external wall* and distance to any adjacent *unprotected areas* shall be restricted to the maximum dimensions specified in Table 5.3.

5.5.6 If the *firecell* is wider than 30 m, the *external wall* shall be divided into a number of 30 m widths and each of these can be assessed separately when considering the size of the largest individual *unprotected area*.

Comment:
This allowance permits the largest individual *unprotected area* to be repeated a number of times along the length of a *firecell external wall* without *fire rated construction* between each *unprotected area*.

Errata 1
Feb 2013

Errata 1
Feb 2013

Table 5.2 Maximum percentage of unprotected area for external walls

Errata 1
Feb 2013

Errata 1
Feb 2013

Risk group CA	Percentage of wall area allowed to be unprotected											
	Angle between wall and relevant boundary up to 45°				Angle between wall and relevant boundary 46° to 60°				Angle between wall and relevant boundary 61° to 89°			
Minimum distance to relevant boundary (m) (see Figure 5.3)	Width of unsprinklered firecell		Width of sprinklered firecell		Width of unsprinklered firecell		Width of sprinklered firecell		Width of unsprinklered firecell		Width of sprinklered firecell	
	Column 2	Column 3	Column 3	Column 4	Column 4	Column 5	Column 5	Column 6	Column 6	Column 7	Column 7	
	Up to 10 m	Greater than 10 m	Up to 10 m	Greater than 10 m	Up to 10 m	Greater than 10 m	Up to 10 m	Greater than 10 m	Up to 10 m	Greater than 10 m	Up to 10 m	Greater than 10 m
Less than 1	0	0	0	0	0	0	0	0	0	0	0	0
1	20	20	40	40	20	20	40	40	23	20	46	40
2	22	20	44	40	25	20	50	40	30	22	60	44
3	25	25	50	50	30	25	60	60	39	25	78	50
4	30	30	60	60	40	30	80	60	50	30	100	60
5	40	30	80	60	50	30	100	60	64	40	100	80
6	45	35	90	70	60	40		80	79	45		90
7	55	40	100	80	70	45		90	90	55		100
8	65	45	100	90	85	50		100	100	65		
9	75	50	100	100	95	55			100	75		
10	90	55		100	100	65				90		
11	100	65				75				100		
12		70				85						
13		80				95						
14		90				100						
15		95										
16		100										

Table 5.3 Maximum size of largest permitted single unprotected area in external walls				
Minimum distance to relevant boundary (m) (see Figure 5.3)	Unsprinklered <i>firecell</i>		Sprinklered <i>firecell</i>	
	Maximum largest single <i>unprotected area</i> (m ²)	Minimum distance to adjacent <i>unprotected areas</i> (m)	Maximum largest single <i>unprotected area</i> (m ²)	Minimum distance to adjacent <i>unprotected areas</i> (m)
1	1	0.5	15	1.5
2	4	1	35	2.5
3	10	5	60	3.5
4	16	7	96	4
5	23	8	139	4.5
6	31	8.5	No requirement	No requirement
7	40	9.5	No requirement	No requirement
8	51	11	No requirement	No requirement
9	64	13	No requirement	No requirement
10	77	13.5	No requirement	No requirement

5.6 Horizontal fire spread from roofs and open sided buildings

5.6.1 THIS PARAGRAPH DELIBERATELY LEFT BLANK

Parapets for storage

5.6.2 For unsprinklered *firecells*, if *combustible* materials are stored on an area of roof within 1.5 m of a *relevant boundary*, but the conditions of Paragraph 5.7.16 (for an adjacent higher wall) do not apply, a parapet shall be *constructed*. The parapet shall extend no less than 1.5 m, or above the top of the stored materials, on the side of the *relevant boundary*. The parapet shall have an *FRR* in accordance with Paragraph 2.3.

Comment:

For vehicle parking on roofs, see Acceptable Solution C/AS7.

Roof projections

5.6.3 If the *external wall* is required to have an *FRR*, the eaves projection shall be *constructed* with the same *FRR* as the *external wall*. Alternatively, the *external wall* shall be extended to the underside of the roof and the eaves need not be *fire rated* (see Figure 5.4).

5.6.4 If the *external wall* is not required to have an *FRR*, roof eaves projecting from that wall need not be rated provided that no part of the eaves *construction* is closer than 650 mm to the *relevant boundary*.

5.6.5 If the *external wall*, on its own, is not required to have an *FRR*, but roof eaves extend to within 650 mm of the *relevant boundary*, the total eaves *construction* and the *external wall* from which they project shall have *FRRs* in accordance with Paragraph 2.3 (see Figure 5.4).

Comment:

Eaves *construction* includes the guttering or spouting and any other projections from the eaves, although guttering or spouting need not be *fire rated*.

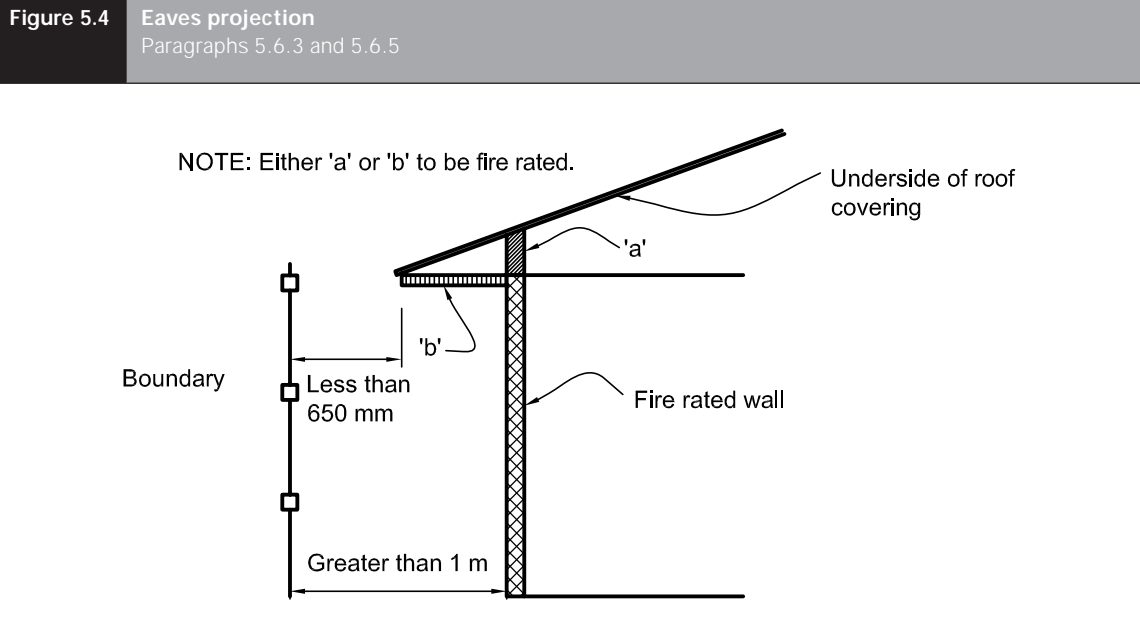

Open sided buildings

5.6.6 An open sided *building* may be either a detached *building* or connected to another *building* (see Figure 5.5). For the open sided *building* to be deemed 'detached', the horizontal distance between the other *building* and the roof of the open sided *building* shall be no less than:

- a) 1.0 m for a roof area exceeding 40 m², or
- b) 0.3 m for a roof area no greater than 40 m².

5.6.7 A *building* having only a single floor level may be *constructed* with walls and roof having 100% *unprotected area* provided that:

- a) At least two sides of the perimeter wall are completely open to the environment, and
- b) If attached to another *building*, both *buildings* are under the control of the same occupancy, and
- c) For unlimited roof plan areas, no part of the roof is closer than 1.0 m to a *relevant boundary*, and

- d) For roof plan areas of no greater than 40 m², no part of the roof is closer than 0.3 m to a *relevant boundary*.

Comment:

Examples of open sided *buildings* having a roof area exceeding 40 m² are porte cochères. Those with roof areas of less than 40 m² include structures such as carports.

Figure 5.5 Open sided buildings – distance and FRR requirements
Paragraph 5.6.6

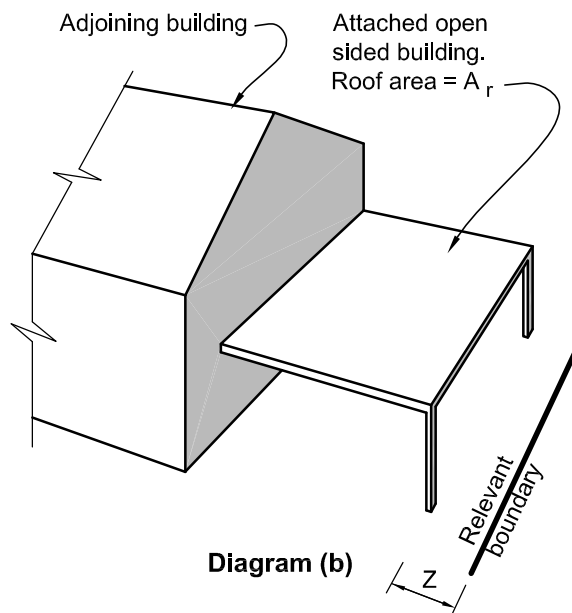
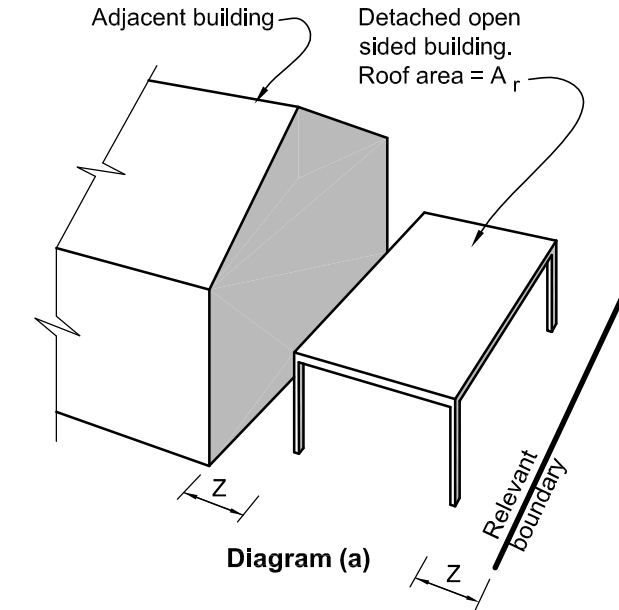

Separation distances for non-fire rated construction

When A_r is no greater than 40 m^2 , 'Z' shall be no less than 0.3 m.
When A_r exceeds 40 m^2 , 'Z' shall be no less than 1.0 m.

NOTES:

1. This figure applies only to single storey open sided buildings.
2. In all cases at least two sides of the perimeter wall shall be completely open to the environment.

5.7 Vertical fire spread

Roofs

5.7.1 Sleeping *risk groups*, *other property* and external *exitways* shall be protected against vertical *fire* spread from roofs.

5.7.2 Protection against *fire* spread shall be achieved using one or more of the following methods:

- a) Separation by distance
- b) *Fire* rating the adjoining *external wall*
- c) *Fire* rating all or part of the roof against the threat of *fire* from the underside
- d) Installing sprinklers in the *firecell* below the roof.

External exitways over roofs

5.7.3 Subject to Paragraph 3.11.4, when an external *exitway* crosses a roof or is above or adjacent to a roof on the same or another *building*, the roof within 3.0 m of any part of the *exitway*, and all supporting elements, shall have an *FRR* in accordance with Paragraph 2.3.

Primary elements

5.7.4 *Primary elements* providing support to an area of *fire* rated roof shall have an *FRR* of no less than that of the roof.

5.7.5 When supporting an unrated roof:

- a) *Primary elements* such as columns or walls which are required to be *fire* rated shall be rated from floor level to the underside of the roof framing members, and
- b) Any roof framing members connected to these *fire* rated columns or walls shall also be rated if their collapse in *fire* would cause the consequential collapse of the rated columns or walls.

Fire spread from an adjacent lower roof

5.7.6 *Fire* spread from a roof close to and lower than an *external wall* shall be avoided by compliance with Paragraph 5.7.7 where *firecells* behind the wall contain *other property*, sleeping *risk groups* SI, SM or *exitways* and are located in the same *building* (as the lower roof), or in an adjacent *building* on the same title.

5.7.7 Where the distance between any part of an *external wall* and a lower roof is less than 9.0 m vertically or 5.0 m horizontally (see Figure 5.6), protective measures shall be applied either to the roof as specified in Paragraph 5.7.8 or to the wall as specified in Paragraph 5.7.9.

5.7.8 Roof protection shall be achieved by:

- a) Providing sprinklers throughout the *building*, or
- b) *Constructing* that part of the roof within 5.0 m horizontally of the wall with an *FRR* in accordance with Paragraph 2.3.

5.7.9 *External wall* protection above an adjacent lower roof shall be provided by *constructing* the critical part of the wall (closer to the roof than 9.0 m vertically or 5.0 m horizontally (see Figure 5.6)) with an *FRR* in accordance with Paragraph 2.3.

Errata 1
Feb 2013

Figure 5.6 External walls and roof, vertical fire spread
Paragraphs 5.7.7 and 5.7.9

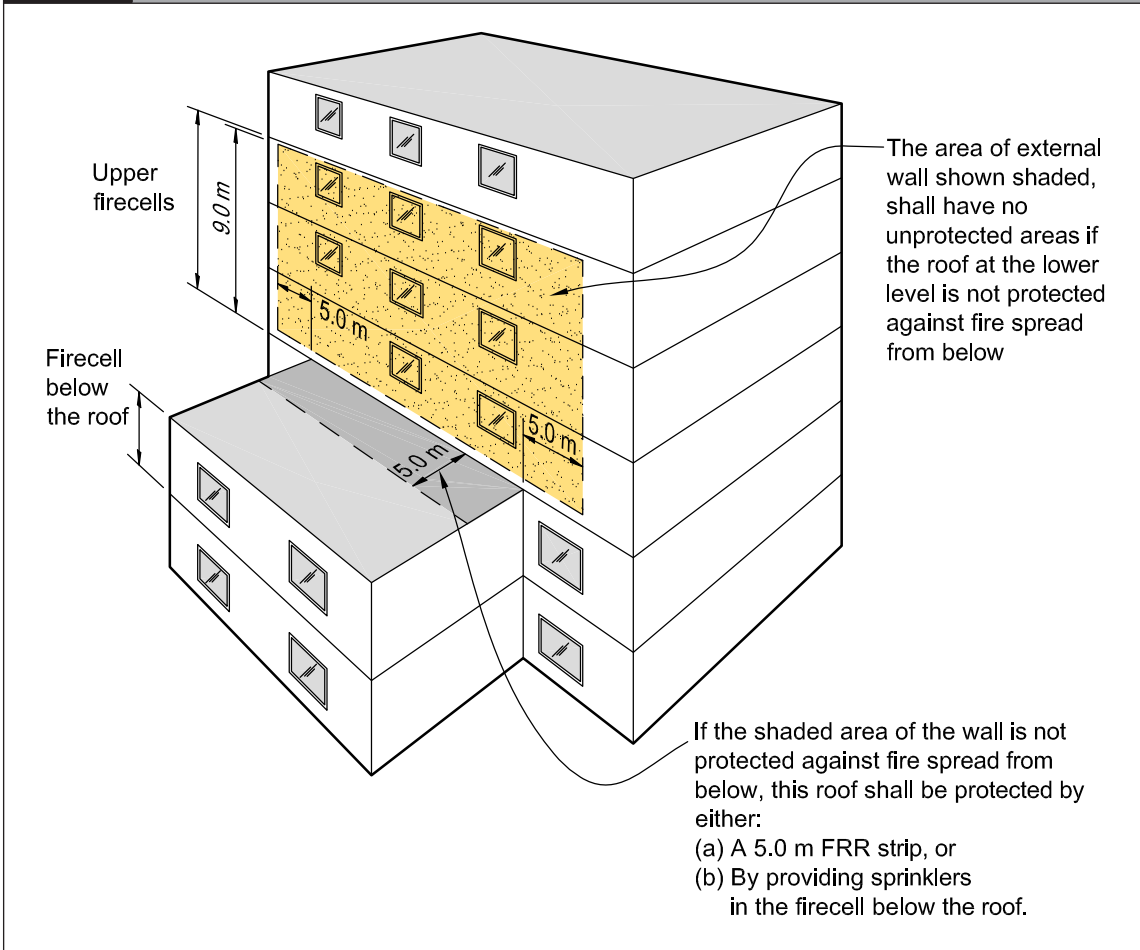

External fire spread between different levels of the same building

5.7.10 Except where *firecells* are sprinklered, *unprotected areas* in *external walls* shall be protected against vertical *fire* spread if any of the following conditions occur:

- Firecells* containing sleeping *risk groups* or *exitways* have an *escape height* of 4.0 m or more, or
- Firecells* containing retail areas have an *escape height* of 7.0 m or more, or
- Firecells* containing *other property* are located one above the other.

5.7.11 If the conditions of Paragraph 5.7.10 occur, *unprotected areas* (see Figure 5.7) in the *external walls* of the *firecells* shall be separated by no less than:

- 1500 mm where any parts of the *unprotected areas* are vertically aligned above one another, or
- 900 mm where the *unprotected areas* on one level are horizontally offset from those on the other level (see Comment: below Paragraph 5.7.13).

Spandrels and apron projections

5.7.12 Spandrels may be omitted where an apron projecting no less than 0.6 m is *constructed*. Table 5.4 specifies the acceptable combinations of apron projection and spandrel height.

Figure 5.7 Separation of unprotected areas
Paragraph 5.7.11

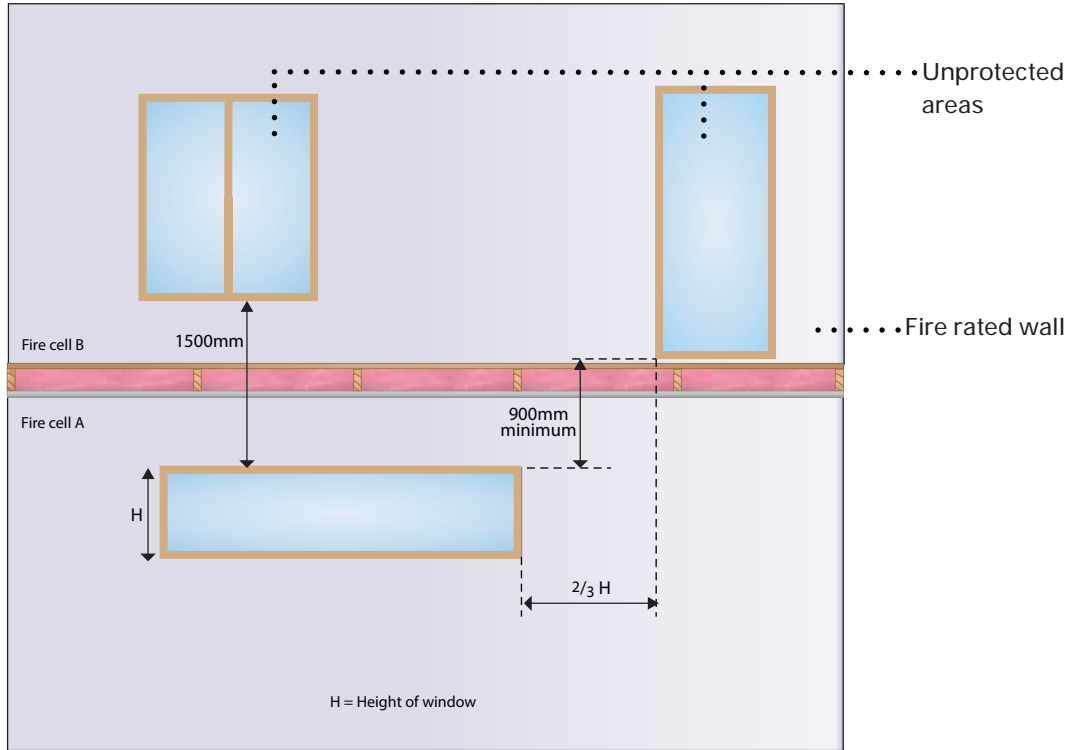

Errata 1
Feb 2013

Apron projection (m)	Spandrel height (m)
0.0	1.5
0.3	1.0
0.45	0.5
0.6	0.0

5.7.13 Aprons shall extend horizontally beyond the outer corners of the *unprotected area* by no less than the apron projection distance. Aprons and spandrels shall have *FRRs* of no less than the floor separating the upper and lower *firecells*. Spandrels shall be rated from both sides. Aprons need only be rated from the underside.

Comment:

The arrangement of windows in each *external wall* is crucial to the prevention of spread of *fire* from floor to floor vertically due to flame projection. The requirements of Paragraph 5.7.11 allow a chess board arrangement, vertical spacing of 1.5 m, or aprons. See also Paragraph 5.3 for application of *FRRs* to *external walls*.

5.7.14 Where there is a gap between an *external wall* and a *fire separation* which together enclose a *firecell*, the space between the *fire separation* and the *external wall* shall be no greater than 50 mm and shall be *fire stopped* (see Paragraphs 4.15.3 to 4.15.5 and Figure 4.10).

5.7.15 Eaves and floors overhanging an *external wall* shall be protected as required by Paragraphs 5.6.3 to 5.6.5.

Roof storage

5.7.16 Storage of *combustible* materials on a roof is not permitted within 1.5 m of a higher *external wall* if the adjacent *building* above contains sleeping *risk groups*.

External thermal insulation on walls in multi-storey buildings

5.7.17 *Buildings* of three or more floors with an *external wall* cladding system incorporating an externally applied *combustible* insulant shall have horizontal *fire stop* barriers installed in the cladding system at intervals of not more than two floors. For framed wall systems, a barrier shall be *constructed* within the framed cavity, and a *fire stop* barrier shall be *constructed* at the same level within the cladding system. An acceptable detail for barriers is shown in Figure 5.8. This requirement does not apply to *combustible* insulant positioned between studs and dwangs/nogs in a conventional framed wall system.

5.7.18 Paragraph 5.7.17 applies where the floors are *fire separations* between *firecells*. It does not apply to any *external wall* satisfying the test requirements of Paragraph 5.8.2 b).

Comment:

Horizontal *fire stop* barriers are needed to prevent progressive involvement of insulants in *fire* by restricting hot gases or flames from travelling upwards within the insulation layer. In practice, it may be necessary to specify movement joints to control cracking of the render or surface coating. These may be conveniently incorporated within barriers. Further guidance and suitable *fire* barrier details may be found in BRE Defect Action Sheet DAS 131 with additional information provided in BRE Report 135.

Combustible insulants may include expanded polystyrene (EPS), polyisocyanurate or polyurethane. The insulants may be covered on the exterior side with a sheet material or with a thin rendered cementitious or polymeric coating. However, Paragraph 5.7.17 still applies.

Figure 5.8 Barriers to vertical fire spread in foamed plastics external insulation systems
Paragraph 5.7.17

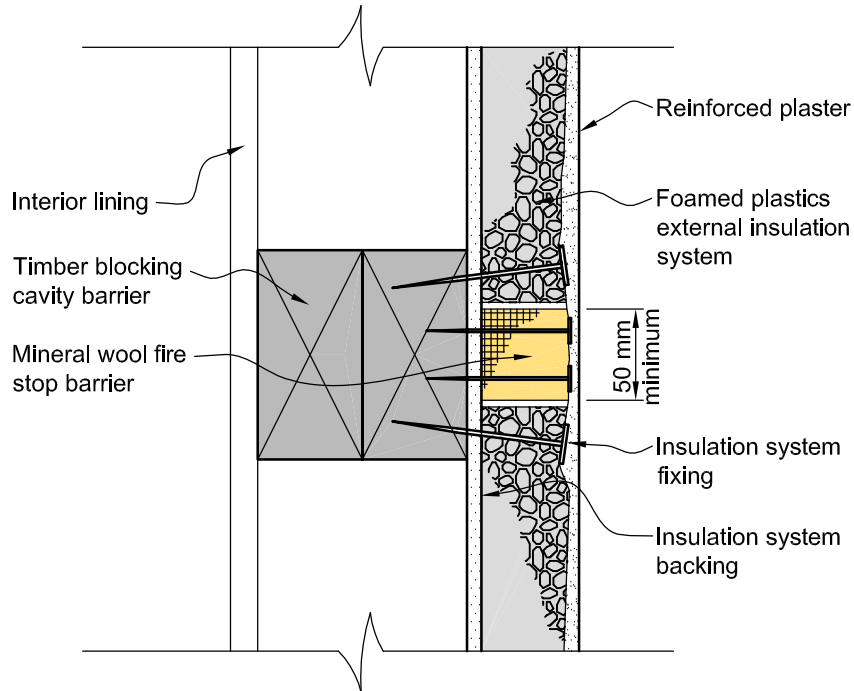

(a) Framed cavity wall construction

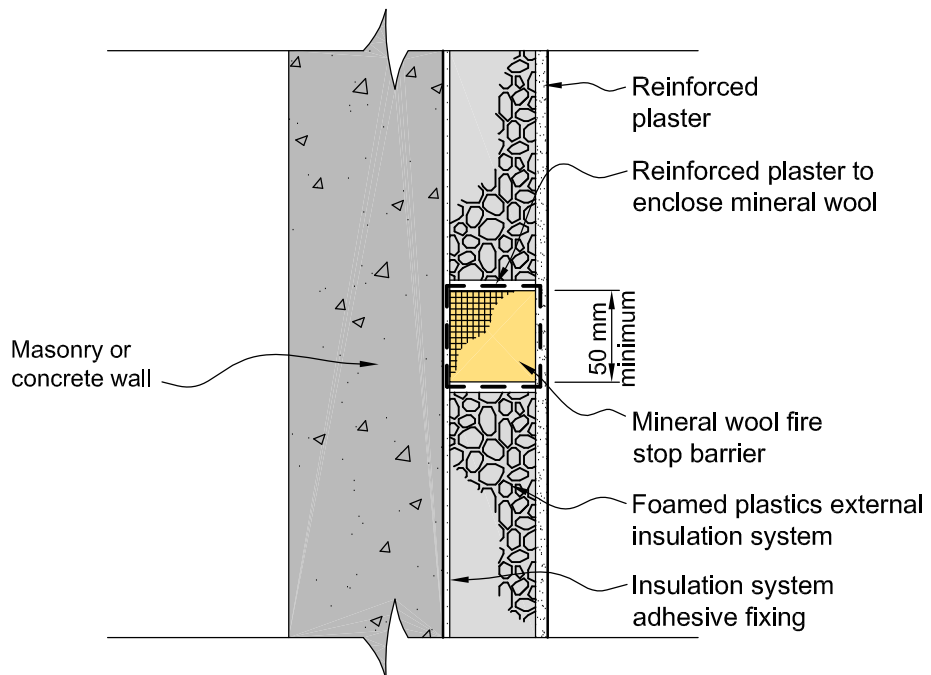

(b) Concrete or masonry wall construction

5.8 Exterior surface finishes

External walls

5.8.1 The *external wall* cladding system shall be tested in accordance with the relevant *standard test* in Appendix C C7.1 and shall satisfy the following requirements:

- a) If the distance to the *relevant boundary* is less than 1.0 m, the peak *heat release rate* shall not exceed 100 kW/m² and the total heat released shall not exceed 25 MJ/m², and
- b) If the distance to the *relevant boundary* is 1.0 m or more and the *building height* is greater than 7.0 m the peak *heat release rate* shall not exceed 150 kW/m² and the total heat released shall not exceed 50 MJ/m².

5.8.2 The requirements in Paragraph 5.8.1 do not apply if:

- a) *Surface finishes* are no more than 1 mm in thickness and are applied directly to a *non-combustible* substrate, or
- b) The entire wall assembly has been tested at full scale in accordance with NFPA 285 and has passed the test criteria.

5.8.3 The requirements in Paragraph 5.8.1 b) do not apply if the *building* is sprinklered and has a *building height* of 25 m or less.

Comment:

Other full-scale façade test methods may also be acceptable to the *building consent authority*.

5.8.4 If a *building* has *firecells* containing different *risk groups*, the acceptable peak *heat release rate* and total heat released of an *external wall* cladding system may have different values provided that:

- a) For each *risk group* the value is no greater than required by Paragraph 5.8.1 for the *building height* (not just the height of the *firecell*), and
- b) The value applied to a *firecell* is no greater than required by any *firecells* at a higher level on that wall.

Comment:

For *external walls*, the acceptable properties of *external wall* cladding systems depend on the *building height*, presence of sprinklers and the distance from the *relevant boundary*.

An *external wall* cladding system includes any applied *surface finish* such as paint or other coating combined with the substrate material. *Fire* tests should be carried out on samples representative of the finished product as used on the *building* to determine compliance.

While the specific *heat release rate* of a cladding system must be verified by *standard test* results, the following is an indication of the performance of some types of *construction*:

- *Non-combustible* materials such as concrete, brick, glass and steel meet the requirements of Paragraph 5.8.1
- Cellulose fibre-cement products with applied finishes/coatings less than 1 mm thick would usually meet the requirements of Paragraph 5.8.1, and
- Ordinary timber products would usually not meet the requirements of Paragraph 5.8.1.

Where the combustibility of a timber product is modified through the application of a *fire retardant* treatment to meet the requirements of Paragraph 5.8.1, it is to be subjected to pre-test accelerated weathering as described in Appendix C C7.1.3.

Part 6: Firefighting

CONTENTS

- 6.1 Fire service vehicular access
- 6.2 Information for firefighters
- 6.3 Access within the building for firefighting and rescue operations
- 6.4 Firefighting facilities

6.1 Fire Service vehicular access

6.1.1 If *buildings* are located remotely from the street boundaries of a property, pavements situated on the property and likely to be used for vehicular access by *fire* appliances shall:

- a) Be able to withstand a laden weight of up to 25 tonnes with an axle load of 8 tonnes or have a load-bearing capacity of no less than the public roadway serving the property, whichever is the lower, and
- b) Be trafficable in all weathers, and
- c) Have a minimum width of 4.0 m, and
- d) Provide a clear passageway of no less than 3.5 m in width and 4.0 m in height at site entrances, internal entrances and between *buildings*, and
- e) Provide access to a *hard-standing* within 20 m of:
 - i) an entrance to the *building*, and
 - ii) any inlets to a *fire* sprinkler or *building fire* hydrant systems.

Comment:

Access to *buildings* for *fire* appliances will be generally via public streets, but provision is needed on large, multi-*building* sites to enable appliances to reach any *building*.

6.1.2 THIS PARAGRAPH DELIBERATELY LEFT BLANK

6.2 Information for firefighters

6.2.1 If *fire* detection and alarm systems or sprinkler systems are installed, the control panel for these shall be located in a position close to the Fire Service attendance point and in accordance with NZS 4512, NZS 4515 and NZS 4541 as appropriate.

6.2.2 If *hazardous substances* are present in the *building*, warning signage in accordance with NZBC F8 shall be displayed.

6.3 Access within the building for firefighting and rescue operations

.....

6.3.1 THIS PARAGRAPH DELIBERATELY LEFT BLANK

Comment:

The requirements for *means of escape from fire* and provision of *fire safety systems* given in Parts 2 and 3 of this Acceptable Solution provide access for firefighting and rescue operations as well as safe egress for *building* occupants.

6.4 Firefighting facilities

.....

Fire hydrant system

6.4.1 *Building fire* hydrant systems shall be installed as specified in Paragraph 2.2 and shall meet the requirements of Appendix A A2.1.1.

6.4.2 The control features of *fire safety systems* shall be located at a position with ready access from street level and protected from the effects of *fire*, including debris falling from upper floors.

Fire Service lift control

6.4.3 Fire Service lift control is required if the *escape height* exceeds 10 m. The control of lifts under *fire* conditions shall comply with NZS 4332.

Part 7: Prevention of fire occurring

CONTENTS

- 7.1 Solid fuel appliances
- 7.2 Gas-burning appliances
- 7.3 Oil-fired appliances
- 7.4 Downlights
- 7.5 Open fires

The design, *construction* and/or installation of certain types of fixed appliances using controlled combustion and other fixed equipment is specified as follows.

7.1 Solid fuel appliances

7.1.1 AS/NZS 2918, with the modifications given in Paragraph 7.1.2, is an Acceptable Solution for the installation of:

- a) Domestic solid fuel burning appliances, installed in either domestic or commercial situations, and
- b) *Flue systems*.

A normative Appendix is an integral part of this Standard.

7.1.2 Modifications to AS/NZS 2918

Delete paragraph 3.8 and substitute the following:

“ 3.8 Seismic restraint

The appliance and the floor protector shall be mechanically fixed to the floor itself.

The test seismic force shall be taken as the application of a horizontal force equal to 0.40 times the appliance weight acting in any direction at the mid height of the combustion chamber. The appliance shall not move, tilt or be dislodged from its installed position during the application of the test force.

The weight of the flue system and a wetback, if fitted, shall not be included in the test.”

Delete Section 7 and substitute the following:

“ 7.1 Ventilation

Ventilation shall be in accordance with Acceptable Solution G4/AS1.

7.2 Water heating equipment

Water heating appliances installed in conjunction with the heating appliance shall be vented and shall comply with Acceptable Solution G12/AS1.”

7.2 Gas-burning appliances

7.2.1 For gas-burning appliances of not more than 250 MJ/H, NZS 5261 sections 2.6.11, 2.6.12 and 2.6.13 and Appendix F are Acceptable Solutions for the *construction* and installation of *flues* and sections 2.6.2, 2.6.3 and 2.7 are Acceptable Solutions for the installation of appliances, with the modifications given in Paragraph 7.2.2.

7.2.2 Modifications to NZS 5261

Delete paragraph 2.6.2.12 and substitute the following:

" 2.6.2.12 Seismic restraint

The appliance shall be mechanically fixed to the building.

The test seismic force shall be taken as the application of a horizontal force equal to 0.40 times the appliance weight acting at the centre of the appliance.

The appliance shall resist the seismic force with no significant movement."

Add a Note to 2.5.7 as follows:

" Ventilation requirements are contained in Acceptable Solution G4/AS1. The ventilation requirements of this Standard may exceed the performance requirements of NZBC G4."

7.3 Oil-fired appliances

7.3.1 AS 1691, with the modifications given in Paragraph 7.3.2, is an Acceptable Solution for the installation of domestic oil-fired appliances.

7.3.2 Modifications to AS 1691

Delete paragraph 2.2.3 and substitute the following:

" 2.2.3 Electrical equipment

Electrical equipment shall comply with Acceptable Solution G9/AS1 or Verification Method G9/VM1."

Delete "CSIRO durability Class 2 or better" from paragraph 3.1.2 (b) and substitute "H5 treatment".

Delete the Note to paragraph 3.1.2 (d).

Delete paragraph 3.1.4 and substitute the following:

" 3.1.4 Stability

The appliance shall be mechanically fixed to the building.

The test seismic force on the fuel tank shall be taken as the application of a horizontal force in kilograms numerically equal to 0.40 times the tank volume in litres acting at the centre of the tank.

The test seismic force on the appliance shall be taken as the application of a horizontal force equal to 0.40 times the appliance operating weight acting at the centre of the appliance.

The appliance and the fuel tank shall resist their respective seismic forces with no significant movement."

Delete the words "without specific approval" from paragraph 3.2.8 (b).

Delete paragraph 5.1.1.

Add Note to 5.2.2:

" Note: Refer to Acceptable Solution G4/AS1 for ventilation requirements."

7.3.3 AS/NZS 2918 Sections 2 and 4 are also Acceptable Solutions for the installation of *flues* for domestic oil-fired appliances.

7.4 Downlights

7.4.1 Recessed luminaires shall be installed with clearances from *building elements* (including insulation) of 100 mm.

Comment:

The requirement for a clearance of 100 mm from recessed luminaires also applies when installing or replacing insulation where recessed luminaires are present.

7.5 Open fires

Chimneys

7.5.1 *Chimneys* shall be *constructed* in accordance with Table 7.1 and Figure 7.1. They shall have:

- a) *Fireplaces* lined with *fire* bricks having a thickness of no less than 50 mm
- b) *Fireplace* joints of *non-combustible* material and shall be sealed against air leakage
- c) *Chimney* brickwork of no less than a single skin of brick 90 mm thick plus a 65 mm thick layer of grout, and
- d) An expansion gap provided in *chimneys* containing *flue liners*. These *flue liners* shall be wrapped in a *combustible* material of thickness no less than 0.25 mm (eg, heavy-quality *building paper*) to prevent the grout filling from bonding with the *flue liner*.

Table 7.1 Minimum acceptable dimensions of chimneys			
Chimney construction	Chimney jamb and chimney back thickness		Chimney breasts and side gathering, and chimney wall thickness above the level of the gather, excluding linings (mm)
	Excluding filling and flue liner (mm)	Including filling and flue liner (mm)	
Concrete	170	255	170
Brickwork	155	230	155
Precast pumice concrete	85	170	85

Figure 7.1 Chimney terms and dimensions
Paragraph 7.5

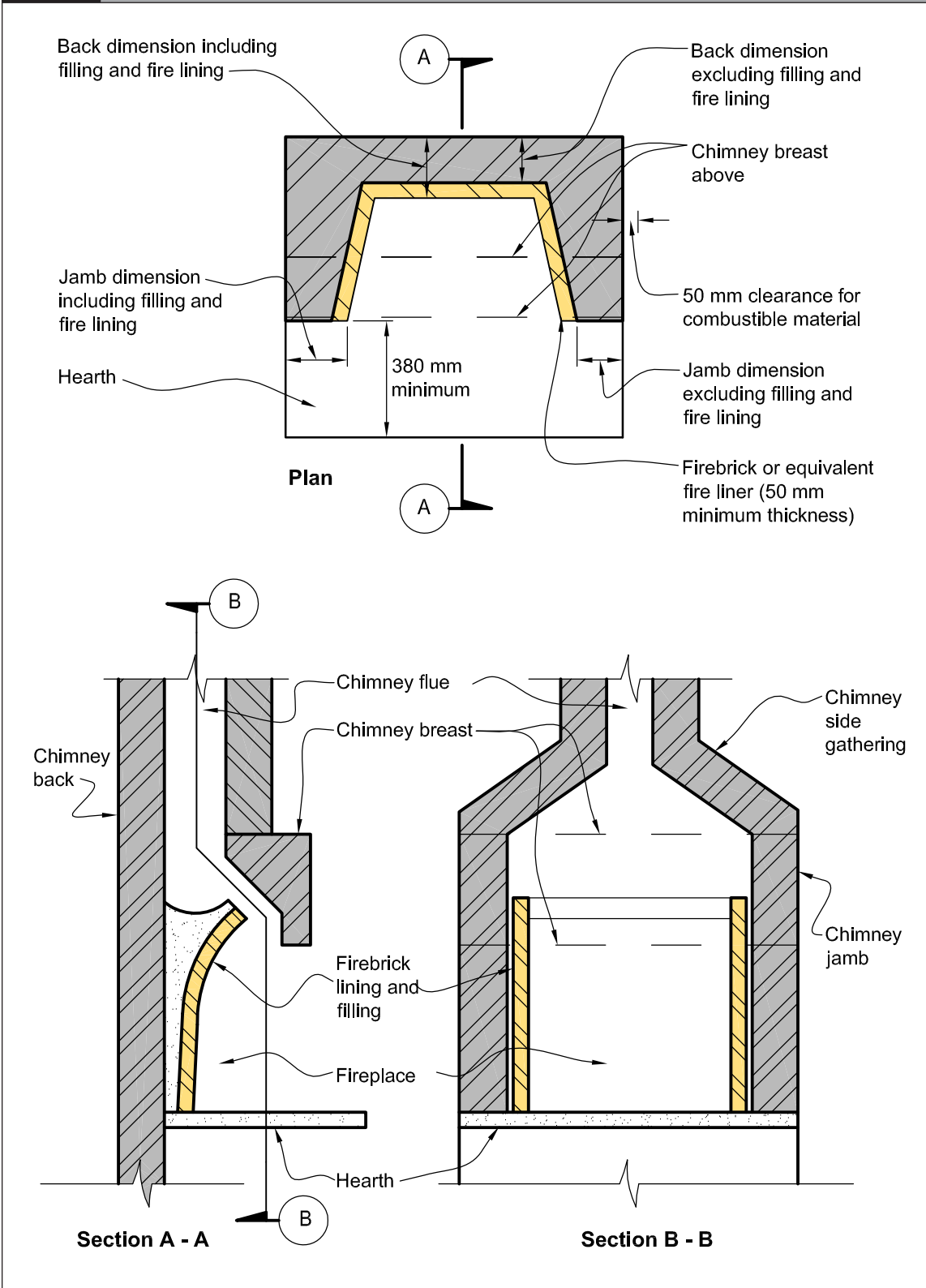

7.5.2 Cross-sectional areas of *flues* shall be no less than 0.03 m² for an open *fireplace* (see Figure 7.2).

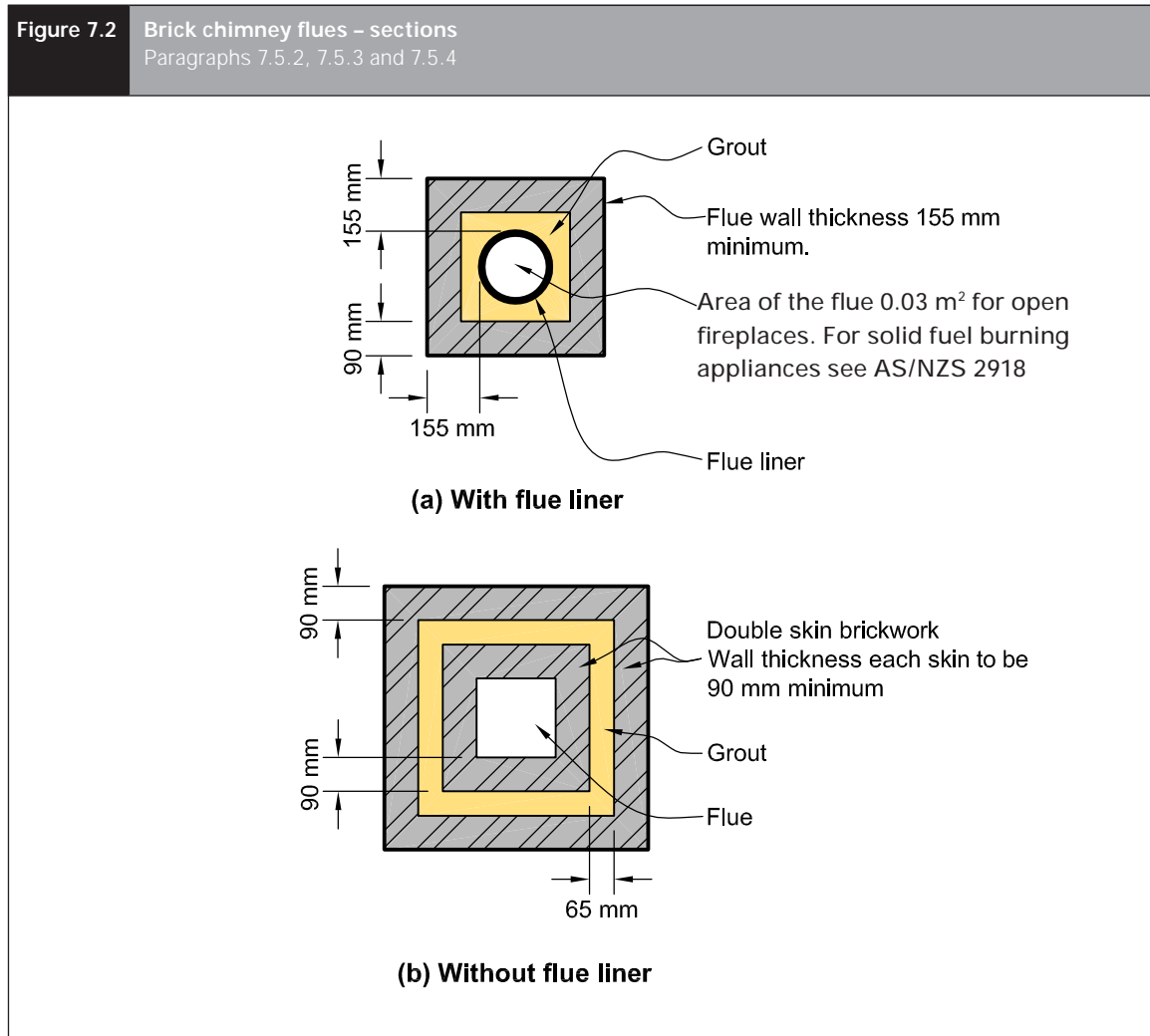

7.5.3 *Flue* linings shall be one of the following types:

- a) Clay *flue liners* with rebated or socketed joints, or
- b) Imperforate clay pipes with socketed joints, or
- c) High alumina cement and kiln-burnt aggregate pipes, with rebated or socketed joints, or steel collars around joints.

The linings shall be fitted with the sockets or rebates uppermost to prevent condensate running out, and to prevent any caulking material from being adversely affected.

Joints between the liners, and any space between liners and the masonry, shall be filled with weak mortar or insulating concrete (see Figure 7.2 (a)).

7.5.4 *Flue liners* are not required for:

- a) Brick *chimneys* if *constructed* of two 90 mm skins of brickwork with a 65 mm grout-filled gap between (see Figure 7.2 b)), or
- b) Ordinary concrete *chimneys*, or
- c) Precast pumice concrete *chimneys*.

7.5.5 Clearance above roofs shall be in accordance with Figure 4.9 of AS/NZS 2918.

7.5.6 Every *fireplace* shall have a separate *flue*.

7.5.7 *Flue* joints shall be of *non-combustible* material and sealed against air leakage.

7.5.8 *Hearths* for *fireplaces* shall:

- a) Be *constructed* of fully grouted stones, bricks or concrete of no less than 50 mm total thickness
- b) Extend no less than 230 mm on each side of the *fireplace* opening and no less than 380 mm forward of the *fireplace* opening, and
- c) Have no *combustible* material closer than the clearances given in Paragraph 7.5.8 b) from the upper and lower surfaces of the *hearth*.

7.5.9 Clearances between a *chimney* and any *combustible* material (see Figure 7.3) shall be no less than:

- a) 200 mm at any opening in the *flue*, or at the *fireplace* opening, and
- b) 200 mm above or below the upper surface of the *hearth*, and 75 mm from the lower surface of the *hearth*.

7.5.10 *Hearth* edges are to be separated from *combustible* material with insulating material having a minimum service operating temperature of 150°C.

Comment:

AS/NZS 2918 Appendix C gives a test method for heat-resistant and heat-tolerant materials.

7.5.11 A ventilated space of no less than 50 mm shall be provided between the outer face of a *fireplace*, *chimney* or *flue* and any *combustible* material.

7.5.12 AS/NZS 2918 Sections 2 and 4 are also Acceptable Solutions for the installation of *flues* from open *fires*.

Figure 7.3 Clearances between a chimney and hearth, and combustible materials
Paragraph 7.5.9

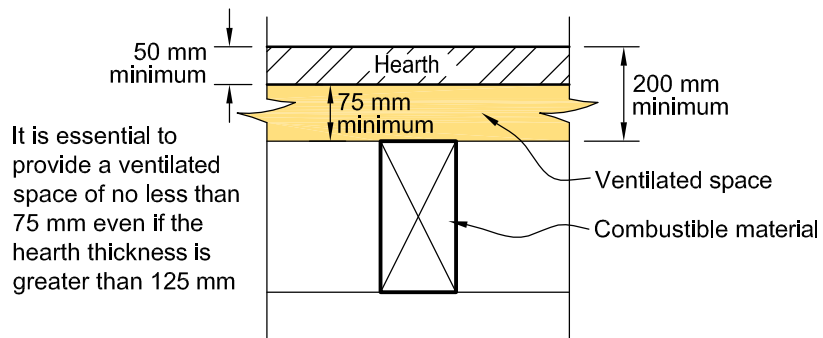
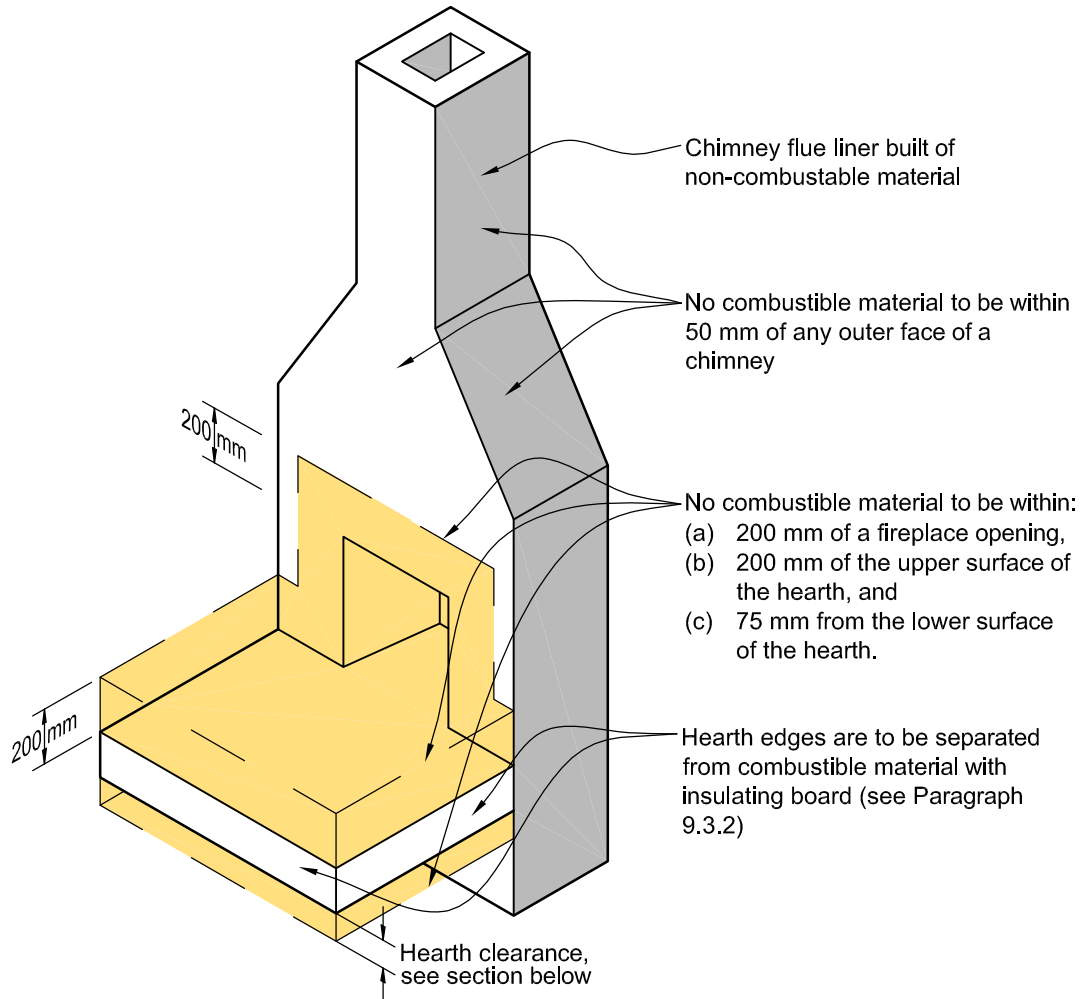

Section showing minimum dimensions

Appendix A (normative): Fire safety systems

A1.1 Fire alarm and sprinkler systems

A1.1.1 *Fire alarm systems used in fire safety systems shall satisfy the requirements of Acceptable Solution F7/AS1. Fire sprinkler systems used in the fire safety systems shall, except where specified, also satisfy the requirements of Appendix B.*

A1.2 Requirements common to alarm systems

A1.2.1 Except for domestic smoke alarm systems and, where otherwise specified, each *fire alarm system*, regardless of method of activation, shall be provided with a means of communication with the Fire Service in accordance with Acceptable Solution F7/AS1.

A2.1 Fire safety system descriptions

A2.1.1 The following text provides a brief description of *fire safety systems* not otherwise described in Acceptable Solution F7/AS1. See F7/AS1 for descriptions of *fire alarm systems* Type 1, 2, 3, 4, 5, 6 and 7.

Type 9 – Smoke control in air handling systems

Where smoke control is required in relation to heating, ventilating or air conditioning systems, it shall comply with the requirements of either:

- a) AS/NZS 1668: Part 1 and interface with any Type 4 or 7 system installed if it is self contained detection, control and provision of output signal/alarm, or
- b) NZS 4512 to provide ancillary function output for control of the *HVAC* system if a Type 4 or 7 alarm system is used as a means of smoke detection.

Type 18 – Fire hydrant systems for buildings

Fire hydrant systems shall comply with NZS 4510.

Appendix B (normative): Fire sprinkler systems

B1.1 Introduction

B1.1.1 Wherever sprinklers are required by this Acceptable Solution, they shall comply with the relevant New Zealand Standard, amended as shown in Paragraphs B2.1 and B3.1.

B2.1 Automatic fire sprinkler systems

B2.1.1 NZS 4541 is amended as follows:

Clause 103 Definitions

Sprinkler system A system including:

- (a) to (i) No change.
- (j) Delete.
- (k) Delete.
- (l) No change.

Clause 205 Delete entire clause.

Clause 208 Delete entire clause.

Clause 1203 Routine Surveys

Clause 1203.1 It is important that a sprinkler system at all times complies with this Standard as amended by Paragraph B2.1 of Appendix B to C/AS4 in all respects. To ensure that building alterations, changes in process or storage patterns or progressive deterioration of system components do not prejudice system compliance, a comprehensive survey shall be carried out biennially at intervals not exceeding 28 months. Such surveys shall be carried out by an independent qualified person.

B3.1 Residential fire sprinkler systems

B3.1.1 NZS 4515 is amended as follows:

Clause 1.5 Definitions

Sprinkler system A system including:

- (a) to (g) No change.
- (h) Delete.

Clause 1.11 Delete entire clause.

Clause 2.1.2 Delete.

Clause 2.1.3 Delete.

Appendix C (normative): Test methods

C1.1 General

This Appendix contains test methods for confirming that specific *building elements* satisfy relevant provisions of the Acceptable Solutions for Protection from Fire. It includes both established *standard tests* and other test methods for *building elements* in situations where *standard tests* are unavailable.

C2.1 Flammability of floor coverings

Materials shall be assigned a critical radiant flux when tested to:

ISO 9239 Reaction to fire tests for flooring – Part 1: Determination of the burning behaviour using a radiant heat source.

C3.1 Flammability of suspended flexible fabrics and membrane structures

Materials shall be assigned a *flammability index* when tested to:

AS 1530 Methods for fire tests on building materials and structures – Part 2: Test for flammability of materials.

C4.1 Properties of lining materials

C4.1.1 Combustibility test

Materials shall be classified as *non-combustible* or *combustible* when tested to:

AS 1530 Methods for fire tests on building materials and structures – Part 1: Combustibility test for materials.

C4.1.2 Materials for internal surface linings shall be given a *Group Number* in accordance with Appendix A of C/VM2 and tested to either:

ISO 5660 Reaction-to-fire tests

- Part 1 Heat release rate (cone calorimeter method), and
- Part 2 Smoke production rate (dynamic method), or

ISO 9705 Fire tests – Full scale room test for surface products.

C5.1 Fire resistance

C5.1.1 *Primary and secondary elements*, closures and *fire stops* shall be assigned a *fire resistance rating (FRR)* when tested to:

- a) AS 1530 Methods for fire tests on building materials and structures – Part 4: Fire resistance tests of elements of building construction, or
- b) NZS/BS 476 Fire tests on building materials and structures – Parts 21 and 22.

C5.1.2 *Fire stops* shall be tested:

- a) In circumstances representative of their use in service, paying due regard to the size of expected gaps to be *fire stopped*, and the nature of the *fire separation* within which they are to be used, and
- b) In accordance with AS 4072: Components for the protection of openings in fire-resistant separating elements – Part 1: Service penetrations and control joints.

C6.1 Fire doors and smoke control doors

C6.1.1 *Fire doors* shall be evaluated in circumstances representative of their use in service, and shall comply with NZS 4520 Fire-resistant doorsets.

Smoke control doors

C6.1.2 A door shall be deemed to be a *smoke control door* if, in addition to the requirements in this Acceptable Solution for *smoke control doors*:

- a) The door is a *fire door* that is fitted with appropriate smoke seals, or if:
- b) It is *constructed* with solid core leaves. Solid timber core leaves, when used, shall have a leaf thickness of no less than 45 mm, and
- c) It is provided with smoke seals as required by this Acceptable Solution. Smoke seals shall be in continuous contact with the mating element, and located so as to minimise interruption by hardware, and
- d) The frames are *constructed* of timber they are no less than 30 mm thick, and

Errata 1
Feb 2013

- e) Any vision panel cut-outs are no less than 150 mm from the leaf edges, and
- f) The maximum average clearances (excluding pre-easing) are:
 - i) Leaf to frame 3 mm
 - ii) Leaf to leaf 5 mm
 - iii) Leaf to top of any floor covering 10 mm, and
- g) Any additional facings shall be adhesive fixed, and
- h) It is provided with signage identifying it as a *smoke control door* in accordance with Acceptable Solution F8/AS1.

Frictional forces

C6.1.3 The forces required to open any *fire door* or *smoke control door* on an *escape route* shall not exceed 67 N to release the latch, 133 N to set the door in motion, and 67 N to open the door to the minimum required width. These forces shall be applied at the latch stile. These requirements do not apply to horizontal sliding doors in *risk group SI* or to power-operated doors.

Self-closing provision

C6.1.4 All *fire* and *smoke control door* leaves shall be self-closing, and provision shall be made for the self-closing device to be adjustable during commissioning to satisfy the requirements of Paragraph C6.1.3 after installation.

C6.1.5 Where it is desirable in normal circumstances for a *fire door* or *smoke control door* to operate freely, it is acceptable to use a self-closer mechanism which activates in the event of *fire* but does not operate at other times.

Comment:

1. These circumstances can occur where people are under care. Leaving the door to the occupant's room (or *suite*) open reduces that occupant's feeling of isolation and permits ready observation by staff.
2. Self-closers can be an obstruction to the elderly and *people with disabilities*, who may have difficulty in opening the door against the pressure applied by the self-closer. Acceptable Solution C/AS3 Paragraph 4.6 describes situations where smoke control doors do not have to be self-closing where they are used within a *group sleeping area* or *suite*.

Automatic smoke-sensing devices

C6.1.6 Automatic smoke-sensing devices complying with NZS 4512, if used, shall be positioned within the stream of air that passes the door when the *smoke control door* is fully open.

C7.1 Fire properties of external wall cladding systems

C7.1.1 *Fire* properties of *external wall* cladding systems shall be determined in accordance with:

ISO 5660 Reaction-to-fire tests –
Heat release, smoke production and mass loss rate –
Part 1: Heat release rate (cone calorimeter method).

C7.1.2 In addition to meeting the general requirements of ISO 5660 Part 1, testing shall be in accordance with the following specific requirements:

- a) An applied external heat flux of 50 kW/m², and
- b) A test duration of 15 minutes, and
- c) The total heat release measured from start of the test, and
- d) Sample orientation horizontal, and
- e) Ignition initiated by the external spark igniter.

C7.1.3 Timber claddings which have a *fire retardant* treatment incorporated in or applied to them shall be subjected to the regime of accelerated weathering described in ASTM D 2898 Method B with the water flow rate from Method A before testing in accordance with the requirements of Paragraph C7.1.1.

C7.1.4 *External wall* cladding systems, which comprise only materials which individually are classified as *non-combustible*, may be deemed to satisfy all the requirements of Paragraph 5.8.1.



Comment:

The *non-combustible* classification represents a more onerous performance level than those required by Paragraph 5.8.1 and is therefore acceptable. A *non-combustible* classification may be claimed only if the respective materials have been subjected to testing as described in Paragraph C7.1.1.

C7.1.5 Claddings incorporating a metal facing with a melting point of less than 750°C covering a *combustible* core or insulant shall be tested as described in Paragraph C7.1.2 without the metal facing present.

Comment:

Aluminium has a melting point of less than 750°C.

Index

References are to the relevant paragraphs, figures or tables in **C/AS4** unless otherwise stated. References to Appendices are prefixed by the Appendix letter.

Alterations and changes of use	1.3
Control of external fire spread	Part 5
External walls – table method	5.5, Figures 5.2 and 5.3, Tables 5.2 and 5.3
Exterior surface finishes	5.8
External walls	5.8.1, 5.8.2, 5.8.3, 5.8.4
Fire separation for buildings with more than one title	5.1
FRRs of external walls	5.3
Small openings and fire resisting glazing	5.4, Figure 5.1, Table 5.1
Horizontal fire spread from external walls	5.2
Separation	5.2.1, 5.2.2, 5.2.3, 5.2.4, 5.2.5, 5.2.6
Analysis required for all external walls	5.2.7
Notional boundary – firecells on the same property	5.2.8, 5.2.9
Horizontal fire spread from roofs and open-sided buildings	5.6
Open sided buildings	5.6.6, 5.6.7, Figure 5.5
Parapets for storage	5.6.2
Roof projections	5.6.3, 5.6.4, 5.6.5, Figure 5.4
Vertical fire spread	5.7
Different levels of the same building	5.7.10, 5.7.11, Figure 5.7
External thermal insulation – multi-storey buildings	5.7.17, 5.7.18, Figure 5.8
Roofs	5.7.1, 5.7.2
External exitways over roofs	5.7.3
Fire spread from an adjacent lower roof	5.7.6, 5.7.7, 5.7.8, 5.7.9, Figure 5.6
Primary elements	5.7.4, 5.7.5
Roof storage	5.7.16
Spandrels and apron projections	5.7.12, 5.7.13, 5.7.14, 5.7.15, Table 5.4
Control of internal fire and smoke spread	Part 4
Building services plant	4.18
Air handling systems	4.18.2
Automatic activation	4.18.1
Closures in fire and smoke separations	4.16
Doorset markings	4.16.5, 4.16.6
Fire door and smoke control door installation	4.16.4
Fire doors	4.16.9, Figures 4.14, 4.15, 4.16
Glazing	4.16.7
Lift landing doors	4.16.11
Introduction	4.16.1, 4.16.2, 4.16.3
Protected shaft access panels	4.16.10
Smoke control doors	4.16.8, Figures 4.12, 4.13 and 4.14

Control of internal fire and smoke spread continued

Concealed spaces	4.15
Cavity barriers in walls and floors .4.15.3, Figures 4.10 and 4.11	
Construction	4.15.5
Exceptions	4.15.4
Unsprinklered firecell restrictions.	4.15.6, 4.15.7, 4.15.8
Within firecells	4.15.2, Figure 4.9
Exhibition and retail areas – special requirements	4.7
Exitways	see Exitways
Firecells	see Firecells
Fire stopping	4.4
Fire stops	4.4.2, 4.4.3, 4.4.4
Introduction	4.4.1
Fire dampers	4.16.12
Fire shutters	4.16.13, 4.16.14, 4.16.15
Floors	4.13
Basement floors.	4.13.9
Flytowers, walkways and similar structures	4.13.8
Intermediate floors.	4.13.4, 4.13.5, 4.13.6
Glazing in fire and smoke separations.	4.2
Fire doors and smoke control doors	4.2.4, 4.2.5
Interior surface finishes, floor coverings and suspended flexible fabrics	4.17.1, Table 4.1
Air ducts.	4.17.11
Educational buildings	4.17.7
Exceptions	4.17.6
Exposed combustible insulating materials.	4.17.2
Flooring.	4.17.3, 4.17.4, Table 4.2
Wood and wood panel products.	4.17.5
Foamed plastics	4.17.2
Membrane structures	4.17.9, 4.17.10
Suspended flexible fabrics.	4.17.8
Intermittent activities	4.10
Plant, boiler and incinerator rooms	4.10.3, 4.10.3 Figure 4.5
Solid waste storage	4.10.2
Support activities	4.10.1
Long corridor subdivision	4.12, Figure 4.7
Protected shafts	4.11, Figure 4.6
Access panels	4.16.11
Fire separation	4.11.2, 4.11.3, Figure 4.17
Lifts, conveyors and services.	4.11.1
Openings	4.11.4
Solid waste and linen chutes	4.11.5, 4.11.6
Structural stability during fire	4.3
Building elements with an FRR	4.3.1, 4.3.2
Horizontal stability	4.3.5
Unrated primary elements	4.3.3, Figure 4.1
Vertical stability	4.3.4
Subfloor spaces.	4.14, Figure 4.8
Theatres – special requirements.	4.6
Closures in proscenium walls	4.6.3, 4.6.4, 4.6.5, Figure 4.4
Stages	4.6.2
Tiered seating	4.8.1, 4.8.2, 4.8.3
Vertical safe path smoke separation	4.9.7

Escape routes

- Dead ends 3.8
 - Ladders 3.8.2
 - No more than 50 occupants 3.8.1
- Doors subdividing escape routes 3.15
 - Access control systems 3.15.7
 - Automatic doors 3.15.7, 3.15.8, Figure 3.24
 - Degree and width of opening 3.15.5, Figures 3.22 and 3.23
 - Delayed action unlocking devices 3.15.11
 - Direction of opening 3.15.3
 - Hold-open devices 3.15.9, 3.15.10
 - Locking devices 3.15.2
 - Panic fastenings 3.15.12, 3.15.13
 - Revolving doors 3.15.7, 3.15.8, Figure 3.24
 - Simple fastenings 3.15.14
 - Vision panels 3.15.6
- Escape through adjoining building 3.4.6, Figure 3.10
- Escape from basements 3.5
 - Single escape routes 3.5.2, Figure 3.11
- Exitways see Exitways
- External escape routes 3.11, Figure 3.18
 - Balconies or bridges 3.11.6, Figure 3.19
 - Ventilation openings 3.11.7
 - Barriers 3.11.8
 - Open air auditoriums 3.11.9, 3.11.10
 - Separation by distance 3.11.2, 3.11.4, 3.11.5
 - Separation by fire rated construction 3.11.6
- Final exits 3.12
 - Separation 3.12.1
- Height and width 3.3
 - Curved and spiral stairs 3.3.5
 - Handrails and limitation to stairway widths 3.3.3, 3.3.4, Figure 3.6
 - Height 3.3.1
 - Obstructions 3.3.6
 - Width 3.3.2, Figures 3.3, 3.4, 3.5
- Length 3.4
 - Intermediate floors 3.4.3, Figure 3.8
 - Open paths 3.4.2, Figure 3.7, Table 3.2
 - Sloping floors and ceilings 3.4.5
 - Stairs and ladders 3.4.4, Figure 3.9
- Number of escape routes 3.2, Figure 3.2, Table 3.1
- Open paths see Open paths
- Safe paths see Safe paths
- Signs 3.16
- Single escape routes 3.13
- Width see Height and width

Exitways

- 3.9, 4.9
- Control of exitway activities 3.10
- Safe paths see Safe paths
- Smoke lobbies – floor area 3.9.2, Figure 3.16
- Smoke lobbies – upper and intermediate floors 3.9.3

Firecells	Part 2, 4.1
Firecell construction	4.5.1, 4.5.2, 4.5.3, 4.5.4
Ceiling space firecells	4.5.8
Junctions of fire separations ..	4.5.5, 4.5.6, Figures 4.2 and 4.3
Junctions with roof	4.5.7
Sealing of gaps	4.5.9, 4.5.10
Fire safety systems	2.2, Table 2.1, Figure 2.1
Early childhood centres	2.2.2
Floor with more than one risk group	2.2.4, 2.2.5, 2.2.6
Other floors in a building	2.2.7
Same risk group on different floors	2.2.8
Floor area limits	2.1.1, 2.1.2, 2.1.3
Passing into an adjacent firecell	3.7.13, Figure 3.15
Provision	2.1
Firefighting	Part 6
Access for firefighting and rescue operations	6.3
Firefighting facilities	6.4
Fire hydrant system	6.4.1, 6.4.2
Fire Service lift control	6.4.3
Fire Service vehicular access	6.1
Information for firefighters	6.2
Fire resistance ratings	Part 2, 2.3, 2.3.1, 2.3.2, 2.3.3
Insulation component	2.3.12, 2.3.13
General requirements	2.3.4, 2.3.5, 2.3.6, 2.3.7, 2.3.8, 2.3.9, 2.3.10, 2.3.11
Fire safety systems	Part 2, 2.2, Table 2.1, Figure 2.1, Appendix A
Early childhood centres	2.2.2
Fire alarm and sprinkler systems	A1.1.1
Fire safety system descriptions	A2.1
Floor with more than one risk group	2.2.4, 2.2.5, 2.2.6
Other floors in a building	2.2.7
Same risk group on different floors	2.2.8
Requirements common to alarm systems	A1.2
Fire sprinkler systems	Appendix B
Automatic fire sprinkler systems	B2.1
Introduction	B1.1
Residential fire sprinkler systems	B3.1
General	Part 1
Scope	1.1, 1.1.1, Table 1.1
Hazardous substances	1.1.5
Outside the scope	1.1.2
Using this Acceptable Solution	1.2
Primary risk groups	1.2.2
Means of escape	Part 3
Escape routes	See Escape routes
General principles	3.1, Figure 3.1
Occupant loads	1.4, 1.4.1, 1.4.2, 1.4.3, Figure 1.1
Fixed seating	1.4.4
Justification for exceptions	1.4.6
Occupant densities	1.4.2, Table 1.2

Open paths	3.6
Exception for education buildings	3.6.3
Intermediate floors	3.17.4
Length	3.4.2, Figure 3.7, Table 3.2
Passing into an adjacent firecell	3.7.13, Figure 3.15
Separation	3.6.2, Figure 3.12
Special cases	3.7
Aisles	3.7.5, 3.7.6, Figure 3.14
Fixed seating	3.7.4, Figures 3.13 and 3.14, Table 3.3
Ramps	3.7.1
Loose seating	3.7.11, 3.7.12
Separate tenancy	3.7.2
Prevention of fire occurring	Part 7
Downlights	7.4
Gas burning appliances	7.2
Modifications for NZS 5261	7.2.2
Oil-fired appliances	7.3
Modifications to AS 1691	7.3.2
Open fires	7.5
Chimneys	7.5.1, 7.5.2, 7.5.3, 7.5.4, 7.5.5, 7.5.6, 7.5.7, 7.5.8, 7.5.9, 7.5.10, 7.5.11, 7.5.12, Figures 7.1, 7.2 and 7.3, Table 7.1
Solid fuel appliances	7.1
Modifications for AS/NZS 2918	7.1.2
Risk groups	1.1.2
Floor with more than one risk group	2.2.4, 2.2.5, 2.2.6
Same risk group on different floors	2.2.7
Primary risk groups	1.2.2
Safe paths	3.9.4, 3.9.5
Length restrictions	3.9.7, Table 3.4
Lifts	3.10.3, 3.10.4, Figure 3.17
Separation, glazing and smoke separation	3.9.9, 3.9.10
Termination	3.9.8
Test methods	Appendix C
Fire doors and smoke control doors	C6.1
Automatic smoke-sensing devices	C6.1.6
Frictional forces	C6.1.3
Self-closing provision	C6.1.4, C6.1.5
Smoke control doors	C6.1.2
Fire properties of external wall cladding systems	C7.1.1, C7.1.2, C7.1.3, C7.1.4, C7.1.5
Fire resistance	C5.1
Flammability of floor coverings	C2.1
Flammability of suspended flexible fabrics and membrane structures	C3.1
General	C1.1
Properties of lining materials	C4.1
Combustibility test	C4.1.1