

**BUILDING  
PERFORMANCE**

# Earthquake geotechnical engineering practice

**Module 6. Earthquake resistant  
retaining wall design**

---

November 2021



MINISTRY OF BUSINESS,  
INNOVATION & EMPLOYMENT  
HĪKINA WHAKATUTUKI



**NEW ZEALAND  
GEOTECHNICAL  
SOCIETY INC**  
[www.nzgs.org](http://www.nzgs.org)

ISBN (print) 978-1-98-851769-8  
ISBN (online) 978-1-98-851768-1

New Zealand Government

---

# Contents

Acknowledgements.....	iv
Preface .....	vi
1 Introduction .....	1
2 Scope .....	3
3 Site geotechnical model .....	5
3.1 Selection of representative design parameters .....	6
4 Performance objectives for retaining structures with earthquake loading .....	8
4.1 Design philosophy and earthquake loading .....	8
4.2 Performance requirements for new retaining structures.....	8
4.3 Natural slopes and formed batters.....	10
4.4 Performance based design .....	11
5 Seismic design parameters .....	12
5.1 Design horizontal acceleration.....	13
5.2 Topographic amplification factor .....	13
5.3 Wall displacement factor .....	14
6 Design of new retaining structures .....	15
6.1 General requirements .....	15
6.2 Serviceability limit state .....	15
6.3 Ultimate limit state .....	16
6.4 Resistance factors.....	17
6.5 Gravity load case .....	17
6.6 Earthquake load case .....	18
6.6.1 Flexible walls .....	18
6.6.2 Stiff walls.....	19
6.6.3 Embedded walls .....	19
6.6.4 Tied-back and propped walls .....	20
6.6.5 Mechanically Stabilised Earth (MSE) walls.....	20

6.7	Global stability.....	20
6.8	Soil parameters .....	20
6.9	Structural design.....	20
6.10	Vertical acceleration.....	20
7	General recommendations .....	21
7.1	Wall backfill .....	21
7.2	Supervision and health and safety issues .....	21
7.3	Timber crib walls.....	22
7.4	Geometry .....	22
8	References.....	23
	Appendix A. Performance observations.....	25
	Appendix B. Worked example 1 .....	28
	Appendix C. Worked example 2.....	35
	Appendix D. Worked example 3 .....	47
	Appendix E. Worked example 4.....	56
	Appendix F. Application of mononobe-okabe equations with high acceleration and/or high back-slope angle .....	66



---

# Acknowledgements

## **NZGS/MBIE EDITORIAL PANEL FOR REVISION 1**

- › Dr Kevin McManus — McManus Geotech Ltd (lead author)
- › Prof Misko Cubrinovski — University of Canterbury
- › Rick Wentz — Wentz Pacific Ltd
- › Nick Traylen — Geotech Consulting Ltd
- › Mike Stannard — Engineering New Zealand (project lead)
- › Tony Fairclough — Tonkin & Taylor
- › John Scott — Earthquake Commission (EQC)
- › Kiran Saligame — Ministry of Business, Innovation & Employment (MBIE)
- › Ananth Balachandra — NZGS
- › Dr Alexei Murashev — WSP
- › Campbell Keepa — WSP
- › Dr John Wood — Contributor

## **NZGS/MBIE EDITORIAL PANEL AND CONTRIBUTORS FOR REVISION 0 (PUBLISHED MAY 2017)**

- › Dr Kevin McManus
- › Prof Misko Cubrinovski
- › Charlie Price — MWH Global (NZGS Chair)
- › John Scott — MBIE
- › Dr Gilles Seve — MBIE
- › Mike Stannard — MBIE
- › Nick Traylen
- › Rick Wentz
- › Kevin Anderson — AECOM
- › Phil Clayton — Beca
- › Dr Alexei Murashev
- › Ross Roberts — Auckland Council

## **MINISTRY OF BUSINESS, INNOVATION & EMPLOYMENT**

- › Jenni Tipler

## **NZGS MANAGEMENT**

- › Ross Roberts

## **ENGINEERING NEW ZEALAND**

- › Kaya Yamabe
- › Eleanor Laban
- › Tania Williams

## **EQC**

- › Jo Horrocks

**DOCUMENT STATUS**

ISBN (print) 978-1-98-851769-8

ISBN (online) 978-1-98-851768-1

New Zealand Geotechnical Society (NZGS) and Ministry of Business, Innovation & Employment (MBIE)  
Earthquake Geotechnical Engineering Practice in New Zealand

Rev 1

Issue date November 2021

**New Zealand Geotechnical Society (NZGS)**

c/ Engineering New Zealand

PO Box 12–241

Wellington 6013

**Ministry of Business Innovation & Employment (MBIE)**

Building System Performance Branch

PO Box 1473

Wellington 6140

**DISCLAIMER**

This document is published by the Chief Executive of MBIE as guidance under section 175 of the Building Act 2004 to assist parties to comply with their obligations under the Building Act 2004.

It is not mandatory to follow the guidance, but if followed:

- › it does not relieve any person of the obligation to consider any matter to which that information relates according to the circumstances of the particular case;
- › users should consider taking appropriate professional advice prior to entering into a construction contract which incorporates all or parts of this document.

While the Ministry of Business, Innovation & Employment, Engineering New Zealand and the New Zealand Geotechnical Society have taken care in preparing this document, it is only a guide. It is not a substitute for legal advice or legislation.

All users should satisfy themselves as to the applicability of the content and should not act on the basis of any matter contained in this document without considering, and if necessary, taking appropriate professional advice.

The document may be updated from time to time and the latest version is available from the Ministry's website at [www.building.govt.nz](http://www.building.govt.nz) or the New Zealand Geotechnical Society's website at [www.nzgs.org/](http://www.nzgs.org/).

**IMPORTANT NOTICE**

The contents may be subject to changes, additions, and deletions. Submissions by the geotechnical community to the Society are encouraged, as it is intended that the guidelines will be updated from time to time.

**© COPYRIGHT**

The copyright owner authorises reproduction of this work, in whole or in part, so long as no charge is made for the supply of copies, and the integrity and attribution of the contributors and publishers of the document is not interfered with in any way.

---

# Preface

This document is part of a series of guidance modules developed jointly by the Ministry of Business, Innovation & Employment (MBIE) and the New Zealand Geotechnical Society (NZGS).

The guidance series along with an education programme aims to lift the level and improve consistency of earthquake geotechnical engineering practice in New Zealand, to address lessons from the Canterbury earthquake sequence and Canterbury Earthquakes Royal Commission recommendations. It is aimed at experienced geotechnical professionals, bringing up to date international research and practice.

This document should be read in conjunction with the other modules published to date in the series:

- › Module 1: Overview of the *Guidelines*
- › Module 2: Geotechnical investigations for earthquake engineering
- › Module 3: Identification, assessment and mitigation of liquefaction hazards
- › Module 4: Earthquake resistant foundation design
- › Module 5: Ground improvement of soils prone to liquefaction
- › Module 5A: Specification of ground improvement for residential properties in the Canterbury region.

Module 6 covers the seismic design of retaining walls of a routine nature throughout New Zealand and should be used in conjunction with established handbooks that cover other aspects of retaining wall design in all situations and soil conditions. It builds on and generalises the MBIE issued supplementary guidance supporting the Canterbury rebuild *Seismic design of retaining structures for residential sites in Greater Christchurch* with accompanying worked examples.

This Revision 1 of Module 6 incorporates feedback received from the engineering community from the earlier revision and includes updated information from research and new developments since Revision 0 was published. It should be read in conjunction with other modules referred to above.

Online training material in support of the series is available on the MBIE and NZGS websites: [www.building.govt.nz](http://www.building.govt.nz) and [www.nzgs.org](http://www.nzgs.org).

We would encourage you to make yourselves familiar with the guidance and apply it appropriately in practice.

**Eleni Gkeli**  
Chair  
New Zealand Geotechnical Society

**Jenni Tipler**  
Manager Building Performance and Engineering  
Ministry of Business, Innovation & Employment



# 1 Introduction



New Zealand is a high earthquake hazard region and earthquake considerations are integral to the design of the built environment in New Zealand. The effects of earthquake shaking need to always be considered in geotechnical engineering practice including the design of retaining structures

Observations of retaining wall performance during earthquakes indicates that well-built retaining walls supporting or surrounded by soils that do not lose strength because of earthquake shaking perform satisfactorily during earthquake events (eg NCHRP, 2008, Bray, 2010, Mikola and Sitar, 2013). In Christchurch, following the Canterbury earthquakes, a significant number of retaining walls in residential properties suffered damage, but many of these were poorly designed and/or constructed. Engineered retaining walls performed well, even though these were unlikely to have been designed to the levels of ground shaking experienced (many may not have been designed for any earthquake loading). A summary of observations from the Christchurch Port Hills following Canterbury earthquakes is provided in Appendix A.

Little formal guidance on the seismic design of retaining structures is available at present. The NZTA Bridge Manual (2018) provides guidance on the earthquake resistant design of retaining walls associated with road and highway infrastructure but these structures are generally subject to higher loadings than other typical structures.

This document is intended to provide guidance for earthquake resistant design of routine retaining structures in New Zealand practice. It is not intended to provide a fully comprehensive treatment of all aspects of retaining structure design and construction in all situations and soil conditions for which well-known published handbooks should be consulted, for example:

- › AS 4678-2002
- › CIRIA 760
- › FHWA (Tied-Back walls)
- › FHWA (Soil nailed walls)
- › Earth Pressure and Earth-Retaining Structures, Third Edition (2014) Clayton et al.

Instead, the intention is to provide supplementary guidance on earthquake design aspects for retaining structures that are not well covered in these handbooks or elsewhere. The main objective is to identify situations where seismic design of retaining structures should be considered, to provide the necessary seismic parameters, and to identify key issues relating to seismic design.

Simplified approaches for everyday design cases are provided. These are not intended to be used for high risk or complex retaining structures for which more sophisticated analysis should be carried out.

Worked examples for common cases are provided in the appendices to provide much additional detail, deliberately excluded from the text for clarity.

Section 2 describes the intended scope for this guideline in more detail. Section 3 discusses the requirements for a suitable geotechnical model for a site. Section 4 discusses the performance objectives for retaining structures with earthquake loading and provides guidance for cases where specific seismic design is necessary and cases

where it may be unnecessary. Section 5 provides seismic design parameters for structures requiring specific seismic design. *Guidelines* for simplified design of new retaining structures are given in Section 6 for a range of different types of structures. Section 7 provides some general recommendations for construction of certain types of structures based on observations from the Canterbury earthquakes.

This document is not intended to be a detailed treatise of latest research in geotechnical earthquake engineering, which continues to advance rapidly. Instead, this document is intended to provide sound guidelines to support rational design approaches for everyday situations, which are informed by latest research. Complex, high risk, and unusual situations are not covered. In these cases, special or site-specific studies are considered more appropriate.

The main aim of this guidance document is to promote consistency of approach to everyday engineering practice and, thus, improve geotechnical earthquake aspects of the performance of the built environment.

This is not a book of rules — users of the document are assumed to be qualified, practising geotechnical engineers with sufficient experience to apply professional judgement in interpreting and applying the recommendations contained within this document.

The science and practice of geotechnical earthquake engineering is advancing at a rapid rate. The users of this document should familiarise themselves with recent advances and interpret and apply the recommendations in this document appropriately as time passes.

## 2 Scope



This document is concerned with the geotechnical design of retaining structures to resist earthquake loading. Earth-retaining structures should be designed to resist earthquake effects in the following situations:

- › Where failure or excessive deformation of the retaining structure might contribute to loss of life within or safe egress from a building (ultimate limit state or ULS) or loss of amenity for a building (serviceability limit state or SLS) including walls < 3 m in height.

OR

- › Where the retaining structure has an effective height greater than 3 m (including the height of batter above or below the retaining structure within a horizontal distance of  $1.5 H$ , where  $H$  is the retained height).

In these cases, the performance of the retaining wall under earthquake shaking needs to be considered appropriately for both SLS and ULS requirements, as recommended in this document.

### Comment

Other cases where the consequences of failure of the retaining structure would be severe should also be designed to resist earthquake effects, eg large watermain within zone of influence, protecting access to IL4 facility, etc.

The intended scope of this document is for those retaining structures covered by the Building Act and requiring a building consent. Requirements for performance and design of retaining walls and formed batters affecting public thoroughfares and other specialist structures are not directly covered in this guidance and the relevant controlling authority should be consulted (eg NZTA Bridge Manual for NZTA roads and bridges ([www.nzta.govt.nz/resources/bridge-manual/bridge-manual.html](http://www.nzta.govt.nz/resources/bridge-manual/bridge-manual.html)) and the pertinent local authority for retaining walls affecting facilities and roadways they control.

The geotechnical performance of the building site including issues of soil liquefaction, cyclic softening, lateral spreading and instability during shaking may have a large impact on the performance of retaining systems and must be carefully considered prior to selecting a suitable retaining system or commencing design. Modules 3 and 4 of the *Guidelines* should be consulted for more detailed information.

The following hierarchy for approaching earthquake resistant retaining structure design is suggested:

- 1 Assess the seismic hazard parameters for the site (refer to Module 1)
- 2 Assess site soils for degradation with shaking, including liquefaction and cyclic softening (refer to Modules 2 and 3)
- 3 Assess site stability with shaking, including lateral spreading and slope instability (refer to Module 4)
- 4 Select the most suitable retaining system
- 5 Design the retaining system for the specified load combinations using guidance provided in this document and elsewhere.

The approach used in this document follows the New Zealand Building Code document B1/VM1. That is, primarily a strength based, limit state, load and resistance factor (LRFD) design process as prescribed in NZS 1170.0:2002 and with earthquake provisions from NZS 1170.5:2004. It is intended that, when properly used in conjunction with these standards and relevant materials standards, the resulting design would comply with the New Zealand Building Code, and through that compliance, achieve the purpose stated in the Building Act 2004 of ensuring that people who use buildings can do so safely and without endangering their health.

B1/VM1 is not the only means of establishing compliance with the New Zealand Building Code. Alternative methods of achieving compliance are possible as explained in the New Zealand Building Code Handbook. A general discussion of alternative, performance based approaches for earthquake resistant retaining wall design is given in Section 4.4.

#### Comment

Dynamic earth pressure loads on retaining structures are difficult to predict and subject to significant variation depending on the characteristics of the earthquake shaking, site conditions, wall geometry, and wall movement (eg Chin et al, 2016). The means of calculating seismic earth pressures for retaining structures is not specified in B1/VM1. This module of the *Guidelines* uses a simplified approach of calculating pseudo-static earth pressures using well-established but simplified procedures (eg the Mononobe-Okabe equations, Wood et al, 1985) using reduced values of peak ground acceleration that adjust for other complexities (eg wave scattering effects) but also acknowledging that certain levels of soil and structure displacement are likely to occur.

This simplified approach may not be appropriate for high risk or high importance retaining structures (eg very high walls) for which more sophisticated analysis (eg finite element method) should be used.

Other documents may provide more specific guidelines or rules for specialist structures and these may take precedence over this document. Examples include:

- › New Zealand Society on Large Dams Dam Safety Guidelines
- › New Zealand Society for Earthquake Engineering Guidelines for Tanks
- › New Zealand Transport Agency Bridge Design Manual
- › Transpower New Zealand Transmission Structure Foundation Manual.

Where significant discrepancies are identified among different guidelines and design manuals it is the responsibility of the designer to resolve such discrepancies as far as practicable so that the design meets the requirements of the Building Code and Building Act.

---

## 3 Site geotechnical model

A site geotechnical model is a simplified representation of the site geotechnical conditions including stratigraphy, ground water, and geotechnical parameters relevant to site performance and foundation design.

The site geotechnical model is usually presented as one or more graphical cross-sections, but for simple sites with uniform stratigraphy, a tabular format may suffice. The level of detail in the model (eg number of layers) should be optimised to facilitate practical analysis of site performance and foundation design.

An appropriately detailed geotechnical investigation of each building site leading to development of a site geotechnical model is a key requirement for achieving good foundation performance. The objective is not simply to describe the soil and rock encountered, but to gain a good understanding of the geology and geomorphology of the site and thus the likely presence of geotechnical hazards such as soil liquefaction. The extent of the investigations should be sufficient to give designers confidence in predicting performance of the site and the building foundations.

An individual site cannot be considered in isolation, but only in the context of adjacent sites and the geomorphology of the area. Context is especially important when considering the risk of soil liquefaction and damaging lateral ground movements during earthquakes and other geological hazards.

The necessary depth of the sub-surface exploration requires careful judgement by the geotechnical engineer or engineering geologist. Frequently, explorations are terminated at too shallow a depth, especially where deep foundations may need to be used. The depth of exploration should extend through all soil strata capable of affecting the performance of the site and the building foundations, and then continued for a sufficient additional depth to give confidence that all potential problem soils have been identified.

Where deep pile foundations are being considered, the exploration should continue well into the proposed bearing layer and at least five diameters below the intended founding depth. For pile groups, the additional depth may need to be equal to the width of the group or greater.

The limitations of the subsurface information and the uncertainties inherent within the model should be recognised and alternative interpretations of the data considered when preparing the site geotechnical model.

Detailed guidance on planning, implementing, and reporting on suitable site investigations is given in Module 2 of the *Guidelines*.

### 3.1 Selection of representative design parameters

The site geotechnical model should include representative soil and rock parameters that will be needed for analysis of site performance and foundation design.

Three approaches are possible:

- a Direct measurement of properties in the laboratory from samples collected from the site
- b Correlation of properties from in situ test data (eg CPT, SPT, etc.)
- c Direct correlation of foundation resistance and settlement from in situ test data

Each of these approaches has advantages and disadvantages. Direct measurement in the laboratory of key parameters mostly requires un-disturbed specimens that may be difficult to obtain in practice (eg clean sands). Laboratory test procedures may not accurately represent the field stress, boundary conditions, or drainage conditions. Usually, only a small number of specimens are tested and these may not have statistical significance or be truly representative of the whole site.

In situ test methods avoid the problem of recovering undisturbed samples and are usually able to be carried out economically in greater numbers than laboratory tests. However, correlations with the required soil parameters include uncertainties because the in situ test result (eg  $q_c$ ,  $N$ ) may be influenced by multiple parameters of the soil or rock simultaneously that are difficult to separate (eg the penetration resistance of the CPT is not only influenced by the shear strength of the soil but also by the soil gradation and stiffness). Site specific correlations with laboratory test data may be very beneficial in improving interpretation of the data and accuracy of the results.

Direct correlation of foundation resistance and settlement with in situ test data avoids the above mentioned difficulties of determining representative soil and rock parameters. At the simplest level, the in situ penetration test may be considered as a small scale model of the prototype foundation (eg CPT, SPT), with the penetration resistance of the in situ device considered analogous to foundation bearing resistance. In practice, empirical factors must be used to adjust for the differences in scale, method of installation, rate of loading, and displacement. The reliability of direct correlation procedures is improved if site specific correlations are developed based on full-scale load tests of prototype foundations.

A summary of field and laboratory methods for determining soil and rock characteristics used for foundation design is given in Table 3.1 [adapted from FHWA 2010]. Much detailed information on the evaluation of soil and rock properties for geotechnical design applications is provided in FHWA [2002].

The selection of representative design parameters for each unit within the site geotechnical model requires careful consideration and judgement by the geotechnical engineer. Whenever more than one data point is available for a unit, a judgement must be made whether to adopt an 'average', 'conservative', lower bound', or 'worst case' value. The decision process should consider a range of issues that will be different for each case including:

- > Amount and variability of data available
- > The design application
- > Extent of physical 'averaging'
- > Criticality of the application

Laboratory data will typically be sparse for each unit and therefore of low statistical significance. More confidence will be obtained by correlating laboratory data to adjacent in situ test data (eg CPT) and using the resulting enhanced correlation and available data to better characterise the unit.

The CPT test typically produces a large number of data points at close (vertical) spacing. It would usually be considered over-conservative to design for a lower-bound value that might represent only a 5 mm thick layer of soil. On the other hand, SPT data points are typically spaced at 1 m or 1.5 m depths and each reading averages a 300 mm thickness of soil. The intrinsic variability and scatter of SPT readings also needs to be considered and excessive reliance should not be placed on any single reading.

Strength parameters used for calculating capacity of critical load bearing foundations are usually chosen to be 'moderately conservative'. Soil stiffness parameters used for settlement calculations are difficult to measure and highly non-linear, and should generally be given as a range, better reflecting the uncertainty in these parameters.

The extent of ‘physical’ averaging of soil parameters for each situation should be considered. For example, the side resistance of a large bored pile will effectively ‘average’ the soil shear strength over its surface, with local variations in strength being of little significance to the total capacity. By comparison, the bearing capacity of a small footing may be significantly reduced by even a small pocket of weak soil within the influence zone of the footing.

Typically, where good numbers of data points are available, the design of a large pile foundation would

be based on using the lower quartile of CPT or SPT data from a nearby sounding. Where few soundings are available to demonstrate the spatial variability across the site, then the worst case sounding overall would be adopted for design.

For small shallow footings, the worst case data might be used unless grade beams are being used to bridge over weak spots and effectively ‘average’ the local soil properties (or, isolated weak spots identified by close spaced in situ testing).

**Table 3.1: Summary of field and laboratory methods for soil and rock characteristics used for foundation design [adapted from FHWA 2010]**

DESIGN PARAMETER OR INFORMATION NEEDED	SUBSURFACE MATERIAL		
	COHESIONLESS SOILS	COHESIVE SOILS	ROCK
<b>Stratigraphy</b>	Drilling–sampling; SPT, CPT, DMT; geophysics	Drilling–sampling; SPT, CPT, DMT; geophysics	Drilling–sampling; rock core logging
<b>Groundwater</b>	Well/piezometer	Well/piezometer	Well/piezometer
<b>INDEX PROPERTIES</b>			
<b>Gradation</b>	Sieve analysis	Sieve analysis; hydrometer analysis	–
<b>Atterberg Limits</b>	–	Liquid limit and plastic limit tests	–
<b>Classification</b>	USCS Group Index	USCS Group Index	Rock type
<b>Moisture content</b>	Wet and oven dried weights	Wet and oven dried weights	–
<b>Unit Weight, <math>\gamma</math></b>	SPT, DMT, CPT	Weight–volume measurements on USS	Weight–volume measurements on rock core
<b>RQD and GSI</b>	–	–	Rock core logging and photos
<b>Slake Durability</b>	–	–	Lab slake durability test
<b>ENGINEERING PROPERTIES</b>			
<b>Effective stress friction angle, <math>\phi'</math></b>	SPT, CPT, DMT	CD or CUpp triaxial on USS	Correlate to GSI
<b>Undrained shear strength, <math>S_u</math></b>	–	CPT, VST, CU triaxial on USS	–
<b>Preconsolidation stress, <math>\sigma'_p</math></b>	SPT, CPT, DMT	Oedometer test on USS; DMT, CPT	–
<b>Soil modulus, <math>E_s</math></b>	PMT, DMT, SPT, CPT; correlate with index properties	Triaxial test on USS; PMT, DMT; correlate with index properties	–
<b>Subgrade reaction modulus, <math>k_s</math></b>	SPT, CPT, PLT	SPT, CPT, PLT	–
<b>Uniaxial compressive strength, <math>q_u</math></b>	–	–	Lab compression test on rock core
<b>Modulus of intact rock, <math>E_r</math></b>	–	–	Lab compression test on rock core
<b>Rock mass modulus, <math>E_m</math></b>	–	–	Correlate to GSI and either $q_u$ or $E_r$ ; PMT, PLT

Key:

CD consolidated drained triaxial compression test  
 CU consolidated undrained triaxial compression test (CUpp — with pore pressures)

CPT cone penetrometer test (also CPTu — with pore pressure measurement)  
 SPT standard penetration test  
 DMT dilatometer test  
 PLT plate load test

PMT pressuremeter test  
 VST vane shear test  
 USS undisturbed soil sample  
 GSI geological strength index  
 USCS unified soil classification system

## 4 Performance objectives for retaining structures with earthquake loading

### 4.1 Design philosophy and earthquake loading

Retaining structures are considered as buildings and subject to the requirements of the New Zealand Building Code.

Limited guidance is available within the supporting documents to the Building Code for the design of retaining walls. NZS 1170.0:2002 specifies general procedures and criteria for the structural design of buildings including retaining walls. The standard covers combinations of actions to be considered including earth pressure and requires that earth pressure loads be determined in accordance with NZS 1170.1:2002. This states that 'earth pressure actions...resulting in lateral loads on earth-retaining structures shall be determined using established methods of soil mechanics.'

NZS 1170.0:2002 requires earth pressure to be combined with factored permanent and imposed actions (dead and live loads) but no requirement to combine earth pressure and earthquake actions is stated. A load factor of 1.5 is specified for earth

pressure unless it is determined using an 'ultimate limit states method', with an example of a suitable methodology being given as AS 4678-2002, 'Earth-Retaining Structures' (recommendation given in the commentary to NZS 1170.0:2002).

This guidance provided herein is intended to meet the objectives of Clause B1 of the Building Code. Even though NZS 1170.0:2002 does not specifically require load combinations including earth pressure and earthquake actions, it will generally be necessary to consider such combinations to fulfil the objectives of Clause B1 of the Building Code.

Other documents provide more specific guidelines or rules for more specialist structures and these should, in general, take precedence over this document. Examples include the NZTA Bridge Manual (for NZTA roads and bridges).

### 4.2 Performance requirements for new retaining structures

The essential performance requirements for all buildings (retaining structures are included as buildings) are given by Clause B1 of the Building Code.

The three principal objectives are:

- a Safeguard people from injury caused by structural failure
- b Safeguard people from loss of amenity caused by structural behaviour
- c Protect other property from physical damage caused by structural failure.

The performance requirements of Clause B1 are applicable to buildings, building elements, and sitework. Retaining structures are buildings in terms of the Building Act and therefore must meet the performance requirements of the Building Code, but may also be building elements

(ie part of other buildings), or part of the sitework. The performance requirements of individual retaining structures in detail will vary according to the particular context of usage.

#### Note

Sitework must meet the performance requirements of Clause B1 whether or not retaining structures are incorporated, ie including formed batter slopes, whether natural cut or filled.



A recommended interpretation of the performance requirements for retaining structures in typical usage situations is provided in Table 4.1 with accompanying sketches in Figure 4.1. Performance is stated in terms of displacement of the structure (in general). Adequate safety against instability or structural failure is implicitly assumed as a requirement in all cases.

Not all situations are covered in these sketches which are provided simply as an aide to interpreting the requirements of the New Zealand Building Code. Retaining walls associated with Importance Level 4 (IL4) facilities in particular require more careful consideration and should be subject to a special study.

**Table 4.1: Performance requirements for retaining structures during earthquakes<sup>1</sup>**

CASE	SITUATION <sup>2</sup>	IL <sup>3</sup>	SLS	ULS
1	Retaining wall integral to building	2,3	No significant <sup>4</sup> movement	Wall movement should not be so excessive as to cause loss of structural integrity or prevent means of safe egress (eg less than 50 mm for normal timber framed construction to NZS 3604)
1a	Retaining wall integral to building	1	No requirement	Wall movement should not be so excessive as to cause collapse of the building (eg less than 150 mm for normal timber framed construction to NZS 3604)
2	Retaining wall supporting building <sup>5</sup>	2,3	No significant <sup>4</sup> movement	Wall movement should not be so excessive as to cause loss of support, loss of structural integrity, or prevent means of safe egress (eg less than 100 mm for normal timber framed construction to NZS 3604)
3	Downslope and supporting building foundations <sup>5</sup>	2,3	Minor movement, <25 mm	Wall movement should not be so excessive as to cause loss of structural integrity or prevent means of safe egress (eg less than 100 mm for normal timber framed construction to NZS 3604)
4	Upslope and within 1.5H of building	2,3	Minimal visual impairment for wall, <H/50	There should be a low risk of collapse of the wall. Wall deformations should not impede egress from the building (noting that severe visual impairment of the wall may deter occupants from escaping the building) (eg less than 100 mm from vertical for typical cases)
5	Facilitating access and services to building (eg driveway)	1,2,3	No requirement	There should be a low risk of collapse of the wall. Wall deformations should not be so excessive as to damage services or prevent use of driveway (eg less than 150 mm from vertical for typical cases)
6	Other situations, H* >3 m	1	No requirement	There should be a low risk of collapse of the wall

#### Notes

- 1 The intent of this table is to give guidance on selecting seismic design parameters for retaining structures. The movements indicated are for typical cases and represent permanent movement from a single design earthquake for selecting appropriate design acceleration coefficients. Instantaneous dynamic movements during an earthquake will be greater and there may be additional movements from gravity loads prior to an earthquake. Some buildings will be more sensitive to movement than others and it is the designer's responsibility to ensure that movements can be tolerated.
- 2 Refer to Figure 4.1.
- 3 Importance level from NZS 1170.0. Might refer to nearby building on adjacent site. Retaining walls for IL4 usage should be the subject of a special study.
- 4 Significant movement would be movement sufficient to cause loss of amenity to the building.
- 5 Building may include existing building on neighbouring property, access and services may include existing access and services to neighbouring property.

Figure 4.1: Typical situations where retaining walls are used for building development

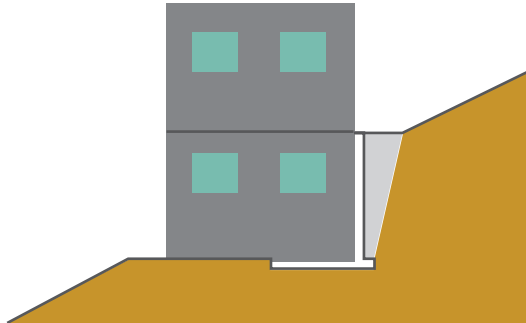

Case 1: Retaining wall integral to building

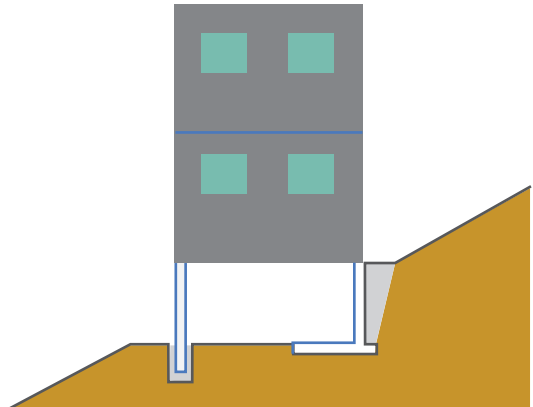

Case 2: Retaining wall supporting building

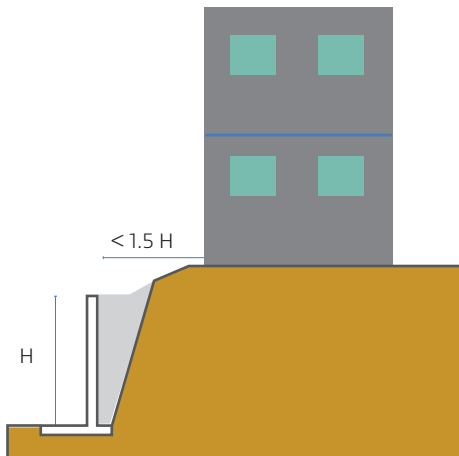

Case 3: Retaining wall supporting foundation

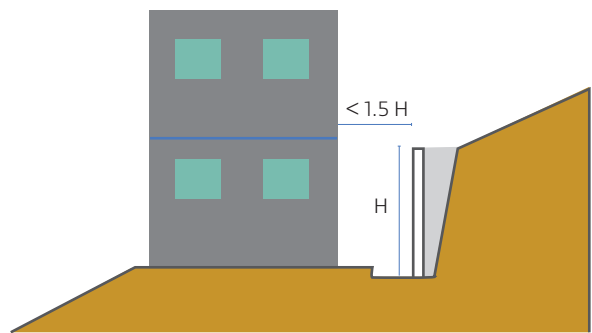

Case 4: Retaining wall protecting building up-slope

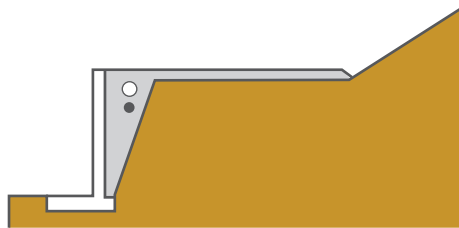

Case 5: Retaining wall facilitating access and services to building

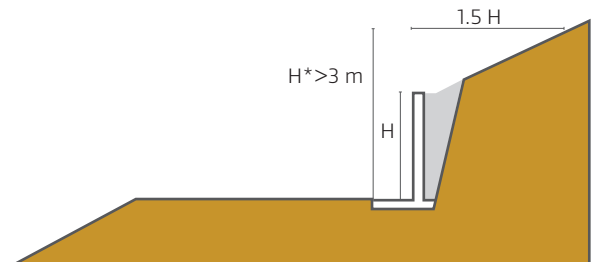

Case 6: Other situations where  $H^* > 3$  m

### 4.3 Natural slopes and formed batters

Where the performance requirements of a building would be jeopardised by failure of a natural slope or formed batter slope (eg cases 3 and 4 in Figure 4.1), then the slope should be engineered to the same level of safety and reliability as a retaining structure in the same situation.

## 4.4 Performance based design

In performance based design, owners and engineers work together to achieve the best possible balance between construction costs and building performance. The New Zealand Building Code is performance based and it is permitted to use alternative design procedures (*alternative solutions*) other than Verification Method B1/VM1 to demonstrate compliance with the Building Code performance requirements.

With performance based design, codified strength based design (eg B1/VM1) is replaced by a more holistic appraisal of the building performance under various loading scenarios. Performance based design requires more sophisticated modelling of building response to loading including dynamic modelling of earthquake loading. Modelling of the foundation system and soil response needs to be included in a rigorous way, including the effects of soil non-linearity, otherwise the results may be misleading and inaccurate. Structural and geotechnical engineers need to work together closely on such studies to achieve realistic results.

Performance based design is arguably the future of earthquake resistant design of buildings. Gazetas (2015) demonstrates a number of possible significant benefits of using performance based design of building–foundation systems in not only reducing the cost of the foundations but improving building safety overall. He adds some cautions, though, including the important caution that the approach is not a ‘panacea’ and is not appropriate for all buildings and all soils, and that differential settlements (eg from variable soil conditions) may inflict additional distress in the superstructure.

The main limitation of performance based design is the inability to reliably predict performance, ie deformation, of the building, especially the foundations, and to properly assess the uncertainty and variability in foundation performance. Uncertainties include the ability of practitioners to be able to make the necessary complex analyses, uncertainty in the models used to make the analyses, uncertainty in the soil properties required as inputs, and spatial variability in site soil conditions between one foundation element and another.

One approach showing promise, is to replace the site soils beneath shallow footings with engineered soils with more uniform and predictable

characteristics of strength and stiffness (Gazetas, 2015, Anastopoulos, 2015). In this way, the foundation performance and building dynamic response could be analysed more readily and with greater reliability.

The New Zealand Building Code prescribes minimum performance requirements including safety and reliability of building systems and these need to be addressed explicitly in performance based design. Key principles from the design philosophy of NZS 1170 should be followed including:

- › Uncertainty in the earthquake loading must be accounted for. For methodologies based on response spectra, the hazard spectra derived from NZS 1170.5 should be the basis for design. For dynamic time history modelling, uncertainty is considered by using a suite of relevant earthquake records, selected and scaled to match the hazard spectra derived from NZS 1170.5
- › Uncertainty in foundation performance and soil response should be accounted for. (Usually by means of a parametric study including a wide range of key soil strength and stiffness parameters.)

### Note

NZS 1170.5 requires a suite of at least three earthquake records, but in international practice it is more common to require 7 to 10 or more scaled earthquake records for time history modelling. For detailed guidance in the selection and scaling of suitable earthquake records refer to NIST GCR 11-917-15 (2011).

Toh et al (2011) report on a soil–foundation–structure interaction, SFSI, study comparing the effects of soil variability and the effect of different earthquakes showed that the earthquake to earthquake variability was more significant than variability in soil properties.

## 5 Seismic design parameters



The simplified approach to design of retaining structures to resist earthquake loading adopted in this module involves application of a pseudo-static design acceleration to the retained ground and mass of the structure in addition to the gravity induced loads.

The pseudo-static design acceleration,  $k_h$ , is derived from the unweighted peak ground acceleration ( $a_{max}$ ) for the site which is a function of the location, return period, and site subsoil class.

Guidance on selecting the appropriate value of  $a_{max}$  to be used for geotechnical design purposes including the seismic design of retaining structures is provided in Module 1. The appropriate return period for calculating  $a_{max}$  is given in NZS1170.0 Table 3.3 depending on the importance level of the structure as defined in NZS1170.0 Table 3.1.

### Comment

Where a retaining structure is providing access or support to a building, then it would have an importance level at least as high as the associated building. For example, a retaining wall supporting the foundations for a primary school building with capacity of more than 250 persons would be considered an IL3 structure.

### Canterbury earthquake region

For retaining structures within the Canterbury earthquake region, the following values for  $a_{max}$  are recommended for the ULS design case, 500 year return period:

- › Class A, B sites      0.3 g
- › Class C sites        0.4 g
- › Class D sites        0.35 g

These values should be considered as interim guidance and may be subject to change as a result of ongoing refinement of the Canterbury hazard models. Reference should be made to the MBIE website for the latest updates.

International experience, including experience from the Canterbury earthquakes, has shown that well-engineered retaining walls have generally performed well during strong earthquake shaking. Designing retaining structures to resist the full ULS value of pseudo-static  $a_{max}$  is considered overly conservative in most cases and international practice

(eg Kramer, 1996) is to reduce  $a_{max}$  by a factor of between 0.33 to 0.5 (ie 1/2 to 1/3). In this module, a factor  $W_d$  is used for this purpose with a recommended range of from 1 to 0.3.

An additional factor,  $A_{topo}$ , is introduced to account for topographic amplification of earthquake acceleration at the site.

**Comment**

In this module we follow international practice by introducing a reduction factor (here termed  $W_d$ , 'wall displacement factor') which is used to reduce  $a_{max}$  by a certain amount depending on the sensitivity of the situation to displacement of the retaining structure. The correlation between  $W_d$  and actual displacement for any given structure will not be exact, as the factor is also adjusting

for other effects including wave dispersion. Nor should it be assumed that adopting a value of  $W_d = 1.0$  would lead necessarily to zero displacement. In general, however, it is expected that smaller values of  $W_d$  would lead to larger permanent displacements than higher values. For cases with a high sensitivity to displacement, a more sophisticated analysis should be carried out.

**5.1 Design horizontal acceleration**

The design horizontal acceleration  $k_h$  is given by the following equation:

$$k_h = a_{max} A_{topo} W_d \quad (5-1)$$

in which  $A_{topo}$  = topographic amplification factor, and  $W_d$  = wall displacement factor. The selection of these additional factors is discussed in the next section.

**5.2 Topographic amplification factor**

Ground shaking may be significantly amplified by certain topographic features including long ridges and cliff tops.

The phenomenon of topographic amplification is well recognised internationally and the following simplified recommendations have been adapted from Eurocode 8, Part 5: BS EN 1998-5: 2004 (Annex A).

**Comment**

Ground shaking in the Port Hills during the Canterbury earthquakes was found to be significantly amplified by certain topographic features including long ridges and cliff tops.

**Table 5.1: Topographic amplification factor**

TOPOGRAPHIC SITUATION	$A_{TOPO}$
For cliff features >30 m in height	1.2 at the cliff edge and the area on top of the cliff of width equal to the height of the cliff
For ridge lines >30 m in height with crest width significantly less than base width, and average slope angle <sup>1</sup> greater than 30°	1.4 at the crest diminishing to unity at the base
For ridge lines >30 m in height with crest width significantly less than base width, and average slope angle greater than 15° and less than 30°	1.2 at the crest diminishing to unity at the base
For average slope angles of less than 15°	1.0

<sup>1</sup> Average slope angle refers to the natural slope angle averaged over the height of the ridge, not the slope angle of the site.

### 5.3 Wall displacement factor

Designing flexible retaining walls to resist the full ULS peak ground acceleration ( $a_{max}$ ) is unnecessary and uneconomic in most cases.

Most retaining wall systems are sufficiently flexible to be able to absorb high transient ground acceleration pulses without damage because the inertia and damping of the retained soil limits deformations. Wave scattering effects also reduce the accelerations in the backfill to values less than the peak ground motions adjacent to

retaining walls. Also, in most cases, some permanent wall deformation is acceptable for the ULS case (refer to Table 4.1)

The wall displacement factor,  $W_d$ , is selected according to the amount of permanent displacement that can be tolerated for the particular design case with guidance given in Table 5.2.

**Table 5.2: Wall displacement factor,  $W_d$  for pseudo-static design of retaining walls for ultimate limit state (ULS)**

CASE (from TABLE 4.1)	SITUATION (refer to Table 4.1 and Figure 4.1)	$W_d$
Case 1	Retaining wall integral to building	0.7
Case 1a	Retaining wall integral to building	0.5
Case 2	Retaining wall supporting building	0.5
Case 3	Downslope and supporting building foundations	0.5
Case 4	Upslope and within 1.5H of building	0.4
Case 5	Facilitating access and services to building (eg driveway)	0.3
Case 6	Other situations, $H^* > 3$ m	0.3

#### Notes

- International practice (eg Kramer, 1996) is to adopt a seismic acceleration coefficient of between 0.33 to 0.5 of the peak ground acceleration for retaining structure design using pseudo-static procedures. Numerous case studies have shown that retaining structures designed in this way have performed satisfactorily during earthquakes, including observations from the Canterbury earthquakes (see Appendix A).
- Reducing the design acceleration by  $W_d$  implies that permanent movement of the structure and retained ground is likely to occur. Several other assumptions are implied, including that:
  - the retaining structure is sufficiently resilient or ductile to withstand the movement
  - the supporting soils are not susceptible to strength loss with straining, and
  - any supported structures or services can tolerate the movement.
- Analysis using 'Newmark's sliding block' approach (eg Jibson, 2007, Bray and Travasarou, 2007, Ambraseys and Srbulov, 1995) indicates that retaining structures designed using the values for  $W_d$  given in Table 5.1 should not exceed the movements indicated in Table 4.1.
- For situations where less movement can be tolerated, a higher value of  $W_d$  should be selected. Wall movement may be estimated using the approach of Jibson (2007). As there is a high level of uncertainty in the source earthquake, the adoption of 84th percentile displacement values is recommended. For high risk retaining structures and for cases with a high sensitivity to displacement, then a more sophisticated analysis should be carried out.
- Alternatively, where it is impractical to limit movements of the retaining structure sufficiently, other measures should be taken as appropriate (eg it may be necessary to found an adjacent building on piles rather than on soil retained behind a wall (Case 3), or there should be structural separation between the retaining wall and building (Case 1 and Case 2).
- $W_d = 1.0$  in all cases for SLS.

## 6 Design of new retaining structures



### 6.1 General requirements

New retaining structures should be designed for both the gravity load case and the earthquake load case using the combinations of actions as specified in NZS 1170.0:2002.

For some structures the gravity load case may be more critical than the earthquake load case. For most structures, both the gravity and earthquake load cases should be checked.

### 6.2 Serviceability limit state

Wall movements should be considered for the SLS level earthquake for Cases 1, 2, and 3 from Table 4.1. Other cases have no SLS performance requirement for earthquake loading.

Wall movements should be checked using the following load combinations:

$$E = [G + F_E + 0.4Q] \quad \text{gravity case} \quad (6-1)$$

$$E = [G + F_S + 0.3Q] \quad \text{earthquake case} \quad (6-2)$$

in which:

$E$  = action effect

$F_E$  = static earth pressure

$F_S$  = pseudo-static SLS earth pressure and wall inertia

$G$  = self-weight (dead load)

$Q$  = imposed action (live load)

### 6.3 Ultimate limit state

Gravity retaining walls (including concrete cantilever walls, mass masonry walls, crib walls, gabion walls) may reach the ultimate limit state by several different modes of deformation:

- › overturning
- › sliding
- › foundation bearing failure
- › deep seated slippage
- › yielding of structure (internal stability).

Embedded walls (including timber pole walls, sheet pile walls) have fewer modes of deformation:

- › overturning
- › deep seated slippage
- › yielding of structure (internal stability).

Tied-back walls and propped walls have additional modes including:

- › ground anchor pull-out
- › tendon extension and failure
- › prop buckling.

Mechanically stabilised earth (MSE) walls have additional modes including:

- › tensile resistance of reinforcement
- › pull-out resistance of reinforcement
- › structural resistance of face elements
- › structural resistance of face element connections.

Additional detail about the various modes of deformation is provided in the worked examples.

All relevant deformation modes (limit states) need to be checked for both the gravity and earthquake load cases. Modes related to stability of the retaining structure should be checked using the following load combinations:

For loads that produce net stabilising effects ( $E_{d,stab}$ )

$$E_{d,stab} = [0.9G] \quad (6-3)$$

For loads that produce net destabilising effects ( $E_{d,dst}$ )

$$E_{d,dst} = [1.2G + 1.5F_E + 0.4Q] \quad \text{gravity case} \quad (6-4)$$

$$E_{d,dst} = [G + E_u + 0.3Q] \quad \text{earthquake case} \quad (6-5)$$

in which:

$E_{d,stab}$  = design action effect, stabilising

$E_{d,dst}$  = design action effect, destabilising

$F_E$  = static earth pressure

$E_u$  = ultimate earthquake action (pseudo-static earth pressure and wall inertia)

$G$  = self-weight (dead load)

$Q$  = imposed action (live load)

When checking stability, the self-weight of the wall and the weight of soil above any heel is acting to stabilise the wall and should be factored by 0.9 for the gravity only load combination and 1.0 for the earthquake load combination. Surcharge loads behind the wall and acting to destabilise the wall should be factored by 1.2 (permanent, 'dead') or 0.4 (imposed, 'live') for the gravity only load combination and 1.0 or 0.3 respectively for the earthquake load combination.

Modes related to strength of structural elements should be checked using the following load combinations:

$$E_d = [1.2G + 1.5F_E + 0.4Q] \quad \text{gravity case} \quad (6-6)$$

$$E_d = [G + E_u + 0.3Q] \quad \text{earthquake case} \quad (6-7)$$

in which:

$E_d$  = design action effect

Surcharge loads behind the wall which are acting to destabilise the wall are increasing loading on the wall and should be factored by 1.2 (permanent, 'dead') or 0.4 (imposed, 'live') for the gravity only load combination and 1.0 or 0.3 respectively for the earthquake load combination.



## 6.4 Resistance factors

For ULS deformation modes related to stability of the retaining structure, using the load combinations and factors given above, the following resistance factors given in Table 6.1 are recommended for *gravity* design of retaining walls.

**Table 6.1: Resistance factors for design of retaining structures for ULS**

DEFORMATION MODE	GRAVITY CASE $\Phi_G$	EARTHQUAKE CASE $\Phi_G$
Foundation bearing failure	0.45 – 0.60	1.0
Rotation of embedded pole wall	0.60 – 0.75	1.0
Sliding on base	0.80 – 0.90	1.0

Note: The lower end of the range is appropriate where simple design procedures are used, limited soil investigation is carried out, or variable soil conditions exist, the higher range is appropriate where more sophisticated design procedures are used, a detailed site investigation is carried out, and where soil conditions are found to be consistent.

For *earthquake* design using a simplified pseudo-static design procedure including the  $W_d$  factor, no resistance factors need be applied to the calculated resistance because it is implicitly assumed that soil yielding may occur during acceleration peaks.

For deformation modes related to stability of the *ground*, including deep seated slippage the above *load and resistance factor* design procedure (LRFD) is not recommended. Instead, a global factor of safety ( $F_S$ ) approach is recommended with appropriate values for  $F_S$  given in Table 6.2.

## 6.5 Gravity load case

For the gravity load case, *moderately conservative* soil parameters should be assumed (ie saturated and softened, highest water table where relevant). Long-term drained parameters should typically be employed in analysis of the gravity load case.

For flexible walls, the soil may be assumed to be in the *active* Rankine state for the ULS and the soil pressure calculated using  $K_a$ . A certain amount of wall movement is required for the active soil condition to develop in the soil behind the wall — approximately 1 percent of wall height. For cases where no significant movement is acceptable at the SLS (eg Case 1 in Figure 4.1) a higher value of earth pressure (typically  $K_0$ ) should be assumed.

**Table 6.2: Factors of safety for pseudo-static assessment of ground stability**

DEFORMATION MODE	GRAVITY CASE $\Phi_G$	EARTHQUAKE CASE $\Phi_G$
Deep seated slippage (global instability)	1.5	1.2

### Notes

- 1 Surcharge loads should be included in the calculation of Factor of Safety. No load factors should be applied to any of the loads (actions).
- 2 These values of Factor of Safety are for moderately conservative estimates of soil parameters, and for soils that are not subject to significant loss of strength with straining. The strength design of structural elements should be carried out using the appropriate material codes including relevant strength reduction factors.
- 3  $F_S = 1.5$  is intended to be for average groundwater conditions. For extreme groundwater conditions including flooding of the retained soil,  $F_S = 1.2$  would be acceptable for the gravity case. Extreme groundwater conditions would not usually be considered to act simultaneously with the design ULS earthquake.

For stiffer walls, (eg concrete walls buttressed by return walls), higher values of earth pressure should be assumed. The gravity load component of the pressure force on stiff walls that deflect less than 0.3 percent of their height can be taken as the at-rest pressure (ie  $K_0$ ).

The effect of backfill slope on the at-rest pressure for stiff walls may be taken from Figure 6.1 for soil friction angles of  $f = 30^\circ$  to  $35^\circ$ . Figure 6.1 assumes that the increase in the at-rest gravity load component with backfill slope will be approximately the same as the increase in the gravity load active pressure.

**Figure 6.1: Increase in at-rest gravity load pressure component from backfill slope for soil friction angles  $f = 30^\circ$  to  $35^\circ$**

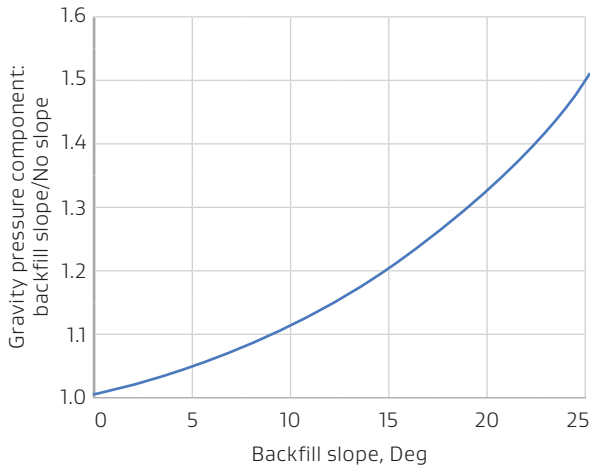

The calculation of lateral earth pressure should include the effect of any surcharge applied to the retained ground (eg the weight of the building in Case 3, Figure 4.1) and appropriate live loads (eg vehicle loads). Load factors and load combinations are given by Equations 6–3 to 6–7.

## 6.6 Earthquake load case

Retaining structures of low to moderate risk and of simple form may be designed to resist earthquake loading by considering a simplified pseudo-static horizontal acceleration.

High risk retaining structures including high walls, complex structures, and structures associated with IL4 facilities, should be subject to more sophisticated analysis.

Flexible walls are treated differently to stiff walls and tied-back or propped walls. Flexible walls are designed assuming development of active earth pressures behind the wall while stiff walls are designed using higher pressures derived from the inertia of the retained soil mass. Tied-back and propped walls are designed using a semi-empirical procedure.

### 6.6.1 FLEXIBLE WALLS

Examples of flexible walls are cantilevered concrete block walls, cantilevered timber pole walls, crib walls, and gabion walls. For the ULS load case the pseudo-static earth pressure may be calculated using  $K_{AE}$  from the Mononobe-Okabe (M–O) equations [refer NCHRP (2008) for a detailed

description of the M–O method plus equations]. Foundations for retaining structures for the gravity load case should be designed using the methods and strength reduction factors given in Module 4 of the *Guidelines*. Wall structural elements should be designed using the methods and requirements of the relevant structural material codes.

Embedded walls (eg timber pole walls) rely on the embedment of the wall below ground level to resist overturning from earth pressure, compared to gravity walls that rely on geometry and bearing resistance to resist overturning. For embedded walls, it is problematic to separate components of load from components of resistance to be able to apply appropriate load factors and resistance factors. Instead it will generally be more appropriate to assess the factor of safety in accordance with an established design procedure, such as the ‘Gross Pressure Method’ used in the worked example (Worked example 1). Appropriate factors of safety are given in Table 6.2 which replace both the load factors and resistance factors of LRFD design.

Tied-back retaining walls and propped walls are typically designed using a semi-empirical procedure (eg FHWA procedure; Sabatini et al, 1999).

Charts giving values of  $K_{AE}$  for various levels of  $k_h$ , wall slope ( $\beta$ ), wall interface friction angle ( $\delta$ ), and backslope angle ( $i$ ) are provided in Appendix B.

For walls where no significant permanent deformation is acceptable, even for the ULS level of shaking, the full PGA should be used to calculate  $K_{AE}$  (ie set  $W_d = 1$ ). (But note that some deformation is still likely to occur).

The inertial effect resulting from the mass of the wall under acceleration  $k_h$ , including the mass of any soil located above the heel, should be added to the calculated lateral earth pressure in all cases.

The calculation of lateral earth pressure should include the effect of any surcharge applied to the retained ground (eg the weight of the building in Case 3, Figure 4.1).

The seismic active earth pressure may be assumed to act at a height  $H/3$  above the base of the wall.

### 6.6.2 STIFF WALLS

The earthquake soil pressure acting on walls that deflect less than 0.4 percent of their height and are restrained against permanent outward sliding displacement (eg buttressed concrete basement walls) will be greater than given by the M–O equation. The earthquake component of the pressure force on stiff walls that deflect between 0.1–0.2 percent of their height can be taken as:

$$\Delta PE = 0.6 k_h \gamma H^2 \quad (6-8)$$

Where  $k_h$  is the earthquake acceleration design coefficient (calculated using  $W_d = 1$ ),  $H$  is the wall height and  $\gamma$  is the unit weight of the backfill.

The earthquake pressure force component on a stiff wall reduces in an approximately linear manner to the M–O earthquake force component at a wall deflection of about 0.4 percent of the wall height as shown in Figure 6.2 (Wood, 1991).

The shape of the pressure distribution changes from uniform to triangular (maximum at the base of the wall) as the deflection increases from about 0.1–0.5 percent of the height. The height of the centre of pressure,  $h_c$ , for a stiff wall is shown in Figure 6.3.

For stiff walls that deflect between 0.1–0.3 percent of their height the earthquake pressure component may be assumed to be uniform over the height of the wall. It will usually be necessary to carry out an iterative analysis to calculate the earthquake pressure force compatible with the deflection.

Backfill slope will result in a significant increase in the earthquake pressure component on stiff walls. Figure 6.4 shows the ratio of the earthquake pressure component for a backfill slope over the pressure component for horizontal backfill [Wood and Elms, (1990)].

### 6.6.3 EMBEDDED WALLS

Embedded walls (eg timber pole walls) rely on the embedment of the wall below ground level to resist overturning from earth pressure, compared to gravity walls that rely on geometry and bearing resistance to resist overturning. For embedded walls, it is problematic to separate components of load from components of resistance to be able to apply appropriate load factors and resistance factors. Instead it will generally be more appropriate to assess the factor of safety in accordance with an established design procedure, such as the ‘Gross Pressure Method’ used in the worked example (Worked example 1). For the earthquake load case,

$K_A$  and  $K_P$  are replaced by  $K_{AE}$  and  $K_{PE}$  calculated using the M–O equations with the factor of safety for the earthquake case given in Table 6.2.

**Figure 6.2: Earthquake pressure force component on stiff walls**

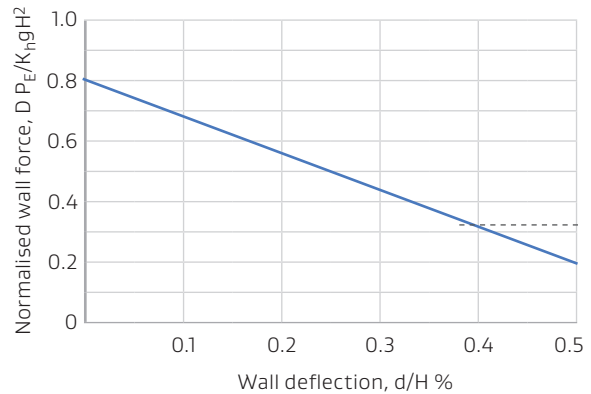

M–O  $\Delta P_{AE}$  for level backfill,  $k_h = 0.1$  to 0.2 and soil friction angle = 30° to 35°

**Figure 6.3: Centre of pressure of earthquake pressure force component on stiff walls**

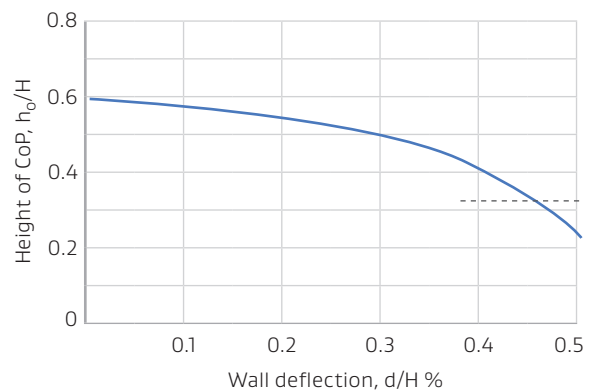

$h_c = 0.33$  for M–O  $\Delta P_{AE}$

**Figure 6.4: Increase in stiff wall earthquake pressure component from backfill slope**

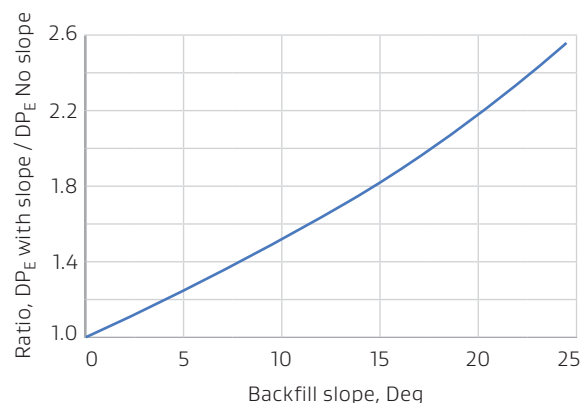

#### 6.6.4 TIED-BACK AND PROPPED WALLS

Special design procedures are required for tied-back walls and propped walls. Guidance for calculation of earthquake induced lateral earth pressures for tied-back walls is given by McManus (2009) based on the FHWA (Sabatini et al, 1999) design procedure for gravity walls, refer Worked example 4.

#### 6.6.5 MECHANICALLY STABILISED EARTH (MSE) WALLS

MSE walls are essentially gravity walls consisting of blocks of soil tied together by various proprietary reinforcement systems consisting of metal strips, geogrids, or geotextiles and with a range of proprietary facing elements. Design of these walls is usually carried out using proprietary software supplied either by the manufacturer or third parties. Detailed generic guidance is provided by Murashev (2003) and by Berg et. al (2009). A design example is provided by Sigurnjak et. al (2021).

### 6.7 Global stability

In circumstances where there is sloping ground above and/or below a retaining wall it is recommended that a global stability analysis is undertaken incorporating the effects of seismic acceleration.

For such analyses, seismic loads may be determined following the same approach as adopted for retaining wall design including consideration of topographic amplification ( $A_{topo}$ ) and, if permanent displacement is acceptable, the use of displacement ( $W_d$ ) factors. Appropriate factors of safety are given in Table 6.2.

### 6.8 Soil parameters

For the earthquake load case, the soil parameters may be assumed for more *average* conditions than for the gravity load case (ie partially saturated, average water table).

Short term, undrained parameters for cohesive soils are typically employed in analysis of the earthquake load case.

The possibility of loss of shear strength and stiffness of the soil from liquefaction, pore water pressure increase, and cyclic softening needs careful consideration. Refer to Module 3 and Module 4 of the *Guidelines*.

### 6.9 Structural design

Wall structural elements should be designed using the methods and requirements of the relevant structural material codes.

### 6.10 Vertical acceleration

The effect of vertical ground acceleration during earthquakes does not need to be specifically considered when designing residential retaining walls.

Based on the assumption of coincident peaks in both the vertical and horizontal ground accelerations, Bathurst and Cai (1995) showed that the increase in earth pressure from vertical accelerations is less than 7 percent when the horizontal seismic design coefficient is less than 0.35. Whitman and Liao (1985) showed that when the peak ground acceleration is less than 0.4 g vertical accelerations increase permanent outward sliding displacements by less than 10 percent. These two studies indicate that, at the level of design accelerations being considered in the Guidance, vertical accelerations can safely be ignored when calculating both the forces acting on the wall and the outward wall displacements.

High risk retaining structures including high walls, complex structures, and structures associated with IL4 facilities, should be subject to more sophisticated analysis where it may be appropriate to consider the effects of vertical accelerations.

## 7 General recommendations



### 7.1 Wall backfill

Experience from the Canterbury earthquakes shows that the use of natural, river rounded drainage gravel as the backfill material behind retaining walls should be avoided where possible.

During strong shaking, flexing of the wall permits the rounds to settle and prevent the wall from returning to its original position, effectively ‘jacking’ the wall out of plane. Crushed aggregates, well compacted should be used in preference to rounded metal.

Irrespective of the backfill used, some settlement of the backfill behind retaining walls should be expected and allowance made in design.

### 7.2 Supervision and health and safety issues

It was apparent that construction quality played a part in the performance of poorly performing retaining walls in the Port Hills during the Canterbury earthquakes. It is therefore recommended that:

- › an appropriately skilled and experienced contractor is selected to undertake the retaining wall works
- › contract specifications are carefully drafted
- › the design assumptions are confirmed at key stages during the construction of the wall — this will require site supervision to be part of the designer’s scope of services to the client
- › the works contract and manufacturer’s specifications are adhered to.

Great care is also required when demolishing and rebuilding a residential retaining wall or building a new wall as the wall may be supporting structures, services and land.

It is important that the responsibility for the design of temporary works is clearly identified. Where temporary works are to be designed by the Contractor, the amount of control which should be exercised to ensure the safety of the temporary works needs to be carefully considered particularly where the ground conditions and/or site geometry are complex or constrained and the consequences of failure or ground displacement potentially significant. Excavations required for the construction of a retaining wall should be designed to have adequate stability. Also, the temporary and permanent works should not lead to unacceptable movements in nearby structures, services and land. Ground deformation monitoring may need to be put in place to assist in managing the risk of damage to adjacent structures.

Designers should also carefully consider their responsibilities to ensure 'Safety in Design', ie that there is a practicable method for safely constructing the retaining structure.

### 7.3 Timber crib walls

Some general recommendations from observation following the Canterbury earthquakes are as follows:

- › Stretchers should be nailed to headers. Joints in stretcher units should be positively fixed using suitable timber connectors. Joints in stretchers should be avoided at the header connection as there is insufficient end distance to make a satisfactory nailed connection of the ends of the stretchers to the header.
- › Capping beams were found to be effective in providing restraint and robustness at the top of the wall.
- › Angular gravel backfill is preferred to rounded gravel.

### 7.4 Geometry

Where possible the face of the retaining wall should be sloped back towards the retained soil (eg by 1H:10V).

This will allow some seismic induced movement to occur without giving the appearance that the wall is leaning over and at the point of failure.

## 8 References

- Ambraseys N and Srbulov M (1995) 'Earthquake induced displacements of slopes.' *Soil Dynamics and Earthquake Engineering*, Volume 14
- Bathurst, R.J. and Cai, Z., 1995, Pseudo-Static Seismic Analysis of Geosynthetic-Reinforced Segmental Retaining Walls, *Geosynthetics International*, Vol.2, No. 5, pp. 787–830
- Berg, R.R., Christopher, B.R., and Samtani, N.C. (2009). 'Design of Mechanically Stabilized Earth Walls and Reinforced Soil Slopes – Volume I,' Report No. FHWA-NHI-10-024 FHWA GEC 011-Vol I, US Dept of Transportation, Federal Highway Administration
- Bray, J.D., 2010, 'Seismic Displacement Design of Earth Retaining Structures,' Earth Retention Conference 3, Plenary Session, ASCE Geo-Institute, Bellevue, Washington, August 3, 2010
- Bray JD and Travarasrou T (2007) 'Simplified procedure for estimating earthquake-induced deviatoric slope displacements'. *Journal of Geotechnical and Geoenvironmental Engineering*, 133(4), 381–392pp
- British Standards Institution BS EN 1998-5:2004 *Eurocode 8 Design of structures for earthquake resistance part 5 Foundations, retaining structures and geotechnical aspects*
- Clayton, C.R.I., Woods, R.I., Bond, A.J., Milititsky, J (2014). *Earth Pressure and Earth-Retaining Structures, Third Edition*, CRC Press
- Gaba, A. et al (2017) CIRIA 760. *Guidance on embedded retaining wall design*
- Dismuke, J. N., 2011, 'Retaining wall performance during the February 2011 Christchurch Earthquake', *Proceedings, Australian Earthquake Engineering Society 2011 Conference*
- GNS Science, 2012. *Canterbury Earthquakes 2010/11 Port Hills Slope Stability: Stage 1 report on the findings from investigations into areas of significant ground damage (mass movement)*. GNS Science Consultancy Report 2012/317
- GNS Science, 2013. *Canterbury Earthquakes 2010/11 Port Hills Slope Stability: Stage 1 report on the findings from investigations into areas of significant ground damage (mass movement)*. GNS Science Consultancy Report 2012/317
- Hughes, T.J. 2002. *A Detailed Study of Banks Peninsula Loess Shear Strength*, MSc Thesis, Department of Geology, University of Canterbury
- Jibson R. W., 2007, Regression models for estimating co-seismic landslide displacements, *Engineering Geology*, 91 [https://profile.usgs.gov/.../ci2009Apr221649194273795-Regression%20models,%20ENGEO.pdf]
- Kramer, S.L. 1996. *Geotechnical Earthquake Engineering*, New Jersey, Prentice Hall
- McManus, K.J. 2009. 'Earthquake Resistant Design of Tied-Back Retaining Structures', *Proc. Tech Conf. N.Z. Soc. for Earthquake Engineering*, Christchurch, NZ, March 2009
- Mikola, R.G. and Sitar, N. 2013. *Seismic earth pressures on retaining structures in cohesionless soils*, UCB/GT-2013-01, University of California, Berkeley, Geotechnical Engineering, (nisee.berkeley.edu/documents/elib/www/documents/GEOTECH/UCB-GT-2013-01.pdf)
- Murashev, A.k. (2003). 'Guidelines for Design and Construction of Geosynthetic-Reinforced Soil Structures in New Zealand,' Transfund New Zealand research Report No 239
- National Research Council 2009 NCHRP Report 611: *Seismic Analysis and Design of Retaining Walls, Buried Structures, Slopes, and Embankments*. Washington, DC: The National Academies Press [onlinepubs.trb.org/onlinepubs/nchrp/nchrp\_rpt\_611.pdf]
- Murashev AK (2003) Guidelines for design & construction of geosynthetic-reinforced soil structures in New Zealand. Research report 239, NZ Transport Agency, Wellington.
- New Zealand Transport Agency, (2018). *Bridge Manual, 3rd Edition, Amendment 3*
- Palmer A. and Cameron S., 2014. *Port Hills Retaining Wall Condition Survey*
- Sabbatini, P.J., Pass, D.G., and Bachus, R.C., 1999. *Geotechnical Engineering Circular No. 4, Ground anchors and anchored systems*, Federal Highway Administration, FHWA-IF-99-015, 281p
- Sigurnjak, M., Follett, B., and Chen, B. (2021). 'Design and construction of an MSE wall for the repair of a washout on the Taupo waterfront-case study,' in *Proc. NZGS Symposium 2021*

Standards Australia AS 4678-2002 *Earth retaining structures*

Standards New Zealand NZS 1170.5:2004 *Structural design actions. Part 5 Earthquake actions — New Zealand*

Standards New Zealand NZS 1170.0:2002 *Structural design actions. Part 0 General principles*

Standards New Zealand NZS 3603:1993 *Timber Structures Standard*

Standards New Zealand NZS 3604: 2011 *Timber Framed Buildings*

Whitman R V, Liao S., 1985, *Seismic Design of Gravity Walls, Miscellaneous Paper GL-85-1*, US Army Corps of Engineers, Washington DC, January 1985

Wood, J, 2014. *Review of Performance of Retaining Walls in the 2010–2011 Canterbury Earthquakes*

Wood J. H. and Elms D. G., 1990. *Seismic design of bridge abutments and retaining walls*, RRU Bulletin 84, Vol. 2, Transit New Zealand

Wood, J.H., 2021. 'Cantilever Pole Retaining Walls', NZ Geomechanics News June 2021, Issue 101, NZGS



# Appendix A. Performance observations

## A.1 General observations in the Port Hills following Canterbury earthquakes

Several studies of retaining wall performance have been undertaken (Dismuke, 2011; Palmer et al, 2014; Wood, 2014).

It is noted that the Palmer et al (2014) survey involved a random selection of 104 retaining walls and did not cover failed retaining walls that had been removed. In some cases, it was also possible that some of the retaining walls inspected had been repaired before the inspection.

The Wood (2014) report was a review of wall damage descriptions in the SCIRT database and excluded facing walls and walls under 1.5 m in height.

The following is a summary of general observations from these surveys:

- › A significant number of retaining walls in residential properties suffered damage. Many of these were poorly designed and/or constructed (eg lack of reinforcement, grouting, or low quality backfilling).
- › Engineered retaining walls performed well, even though these were unlikely to have been designed to the levels of ground shaking experienced (many may not have been designed for any earthquake loading).
- › Walls that retained fill often did not perform as well as those that retained undisturbed loess soil.
- › Retained fill settled significantly, especially behind more flexible walls such as timber pole walls, timber crib walls and gabion walls.
- › Many non-engineered rock facings, which are generally quite old structures, collapsed exposing stable, near vertical faces of undisturbed loess indicating that undisturbed, dry loess typically has high apparent cohesion under short term loading conditions.

- › Several retaining wall failures appeared to be initiated by slope instability either above or below the wall.
- › While there were numerous observations of outward movement of well-engineered retaining walls they were still fully functional post the earthquake sequence.

**Figure A.1: Failure of poorly constructed concrete block retaining wall**

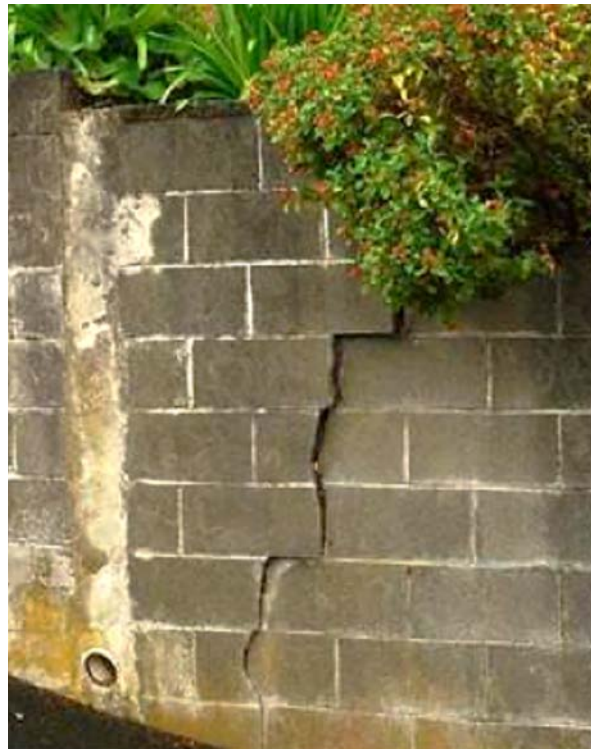

More specific observations following the Christchurch earthquakes for the most common types of walls were made as follows:

#### A.1.1 CONCRETE BLOCK WALLS

Engineered concrete block walls, whether cantilevered, buttressed, or propped generally performed well. Those that were propped or buttressed exhibited less damage than those in pure cantilever.

Where concrete block basement retaining walls were constructed integral with the building little if any major structural damage resulting from ground shaking was observed. The only significant structural damage to these types of walls was observed in areas affected by land damage (predominantly in the 'toe slump' areas). Observed wall rotations in these integral basement type walls were typically less than 1 percent from vertical, regardless of whether the walls were buttressed or not, and/or propped at the top or not. It was not possible in all cases to confirm whether these rotations were earthquake loading related.

Settlement of the drainage fill behind concrete block retaining walls was commonly observed. The settlement of fill did not necessarily coincide with excessive wall rotations. Possibly, the drainage fill had been placed loose, without adequate compaction and the resulting settlement was a 'shaking down' or densification of the backfill

under the earthquake loads. Drainage fill was observed to typically comprise rounded river gravel. Settlement of fill of up to 200 mm was observed for a typical single storey basement retaining wall. Failure of the drainage system behind basement block retaining walls was uncommon in the walls observed.

**Figure A.2: Damaged concrete block basement wall**



#### A.1.2 TIMBER POLE WALLS

Engineered timber pole walls generally performed well. Failures of cantilever walls were observed where post sizes, post spacing, or embedment depths appeared inadequate and were probably not of engineered design/construction.

Localised structural failures were observed more often in tied-back walls. Undersized washers on tie-back anchors were common resulting in crushing of timber. Bowed posts were common where there were tie-backs providing restraint towards the top of the wall. Vertical splits in poles were also common, but are of little structural significance.

Pull through of washers and nuts was more commonly observed than failure of the tie-back anchors themselves. However, anchor failures were observed on a few walls.

**Figure A.3: Damaged timber pole wall showing failure of poles at anchor location and failure of anchors**



### A.1.3 TIMBER CRIB WALLS

There was quite a wide variation in seismic performance observed for timber crib walls. It appears that this variability is much more strongly influenced by construction details and practice rather than fundamental design. A particular construction issue was the use of rounded gravel backfill within the wall units. Rounded material tends to shake out leaving voids between the block units and settlement of the ground or pavements above the wall. Certain construction practices appeared to perform better than others. For example, fixing of the header to the stretcher appears to improve wall performance by serving to minimise aggregate 'shake out.'

### A.1.4 CONCRETE CRIB WALLS

There was also a wide variation in performance observed for concrete crib walls and therefore most of the timber crib wall comments also generally apply to concrete crib walls. In some cases vegetation on the face of the wall appeared to improve performance by serving to retain the gravel backfill.

### A.1.5 GABION WALLS

The use of gabions in residential settings is less common except in cases where land deformation is likely or where land slip remediation has been undertaken. They tend to be more widely employed on road reserve areas at the subdivision level of development, or for supporting heavier civil infrastructure. Quite often the uppermost one or two courses slumped outwards (>200 mm) with significant cracking and settlement behind the wall in these instances. Outward movement was caused by both the stretching of the baskets, and rotation around the base of the walls. There was also evidence of a shake-down effect of the retained material in gabion walls.

**Figure A.4: Damaged timber crib wall**



**Figure A.5: Concrete crib wall showing loss of rounded gravel backfill**



**Figure A.6: Gabion wall showing bulging and outwards movement**



## Appendix B. Worked example 1

### B.1 Design of cantilever pole retaining walls to resist earthquake loading

Cantilever timber pole walls are very commonly used in New Zealand for reasons of economy and ease of construction. The poles may also be of steel or concrete section for more heavily loaded walls. The design of these walls is relatively straight forward but several modes of failure need to be considered. The most common problem with these walls is rotation about the base because of inadequate depth of embedment of the poles, often because of over-estimating the appropriate soil strength parameters or use of wrong design models.

#### B.1.1 POSSIBLE MODES OF FAILURE

Possible modes of failure for cantilever pole retaining walls are illustrated in Figure B.1. A complete design should address each of these modes of failure where appropriate.

- Foundation failure:** The embedded pole foundations rotate through the soil.
- Pole structural failure:** The poles fail in bending. Most likely location is at the ground surface where the poles are embedded in substantial concrete foundations otherwise may be below the ground surface.
- Sliding failure of wall:** Possible mode for non-cohesive soils. Wall moves outwards with passive failure of soil in front of wall and active failure of soil behind wall. Factor of safety controlled by increasing depth of embedment of wall. Unlikely to govern design for typical cases.
- Deep seated rotational failure:** Possible mode for cohesive soils. Factor of safety controlled by increasing depth of embedment of wall. Factor of safety calculated using limiting equilibrium 'Bishop' analysis or similar. Unlikely to govern unless wall is embedded into sloping ground with sloping backfill or there is a weak layer at the toe of the wall.

Figure B.1: Possible modes of failure for cantilever pole retaining walls

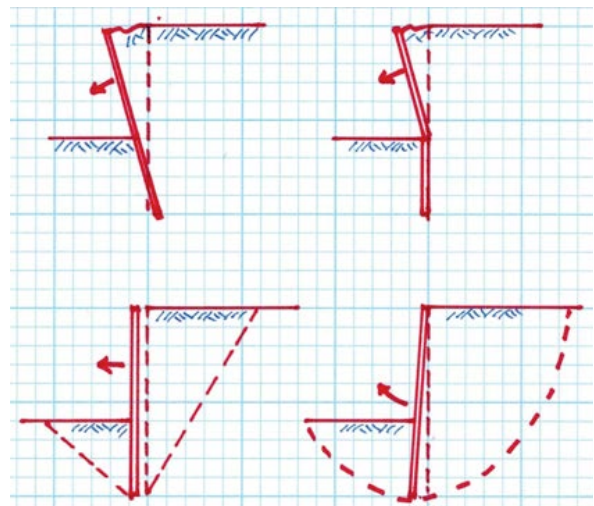
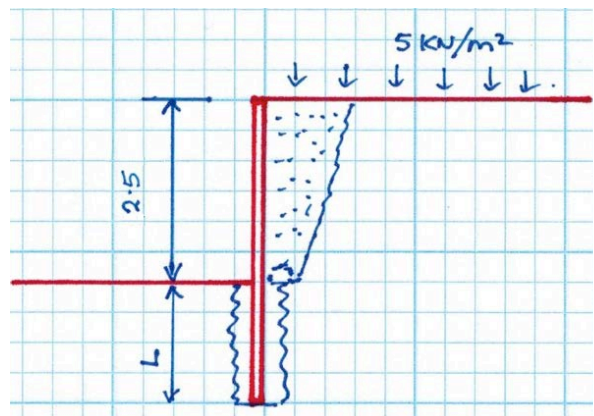

Figure B.2: Cantilever pole retaining wall example



Wood (2021) provides a detailed review of available analysis and design methodologies for timber pole cantilever retaining walls including both geotechnical and structural aspects. The following worked example follows the recommendations made therein. The load acting against the wall above foundation level is calculated assuming active soil pressures (ie the wall is assumed to be 'flexible'), LRFD load factors are applied, and the resulting lateral force and overturning moment is applied to the individual poles. The resistance of the pole foundation is calculated under the factored loads, a LRFD resistance factor is applied, and the design inequality is checked.

This procedure is intended to be readily calculated by hand, although use of calculation software such as Mathcad or Excel will be useful for design iterations. The example calculations are made here using Mathcad.

### B.1.2 EXAMPLE WALL

The example wall is shown in Figure B.2. The wall is assumed to be located in the Christchurch Port Hills. The following design assumptions were made:

- › **Soil type:** Port Hills loess
- › **Strength parameters:**  $c = 0$ ,  $\phi = 30^\circ$

Drained strength parameters for Port Hills loess were assumed for the long term, gravity only load case. For the earthquake load case, the foundations in loess were designed assuming undrained strength,  $c = 50 \text{ KN/m}^2$ ,  $\phi = 0^\circ$ , when calculating the passive resistance of the foundation soil.

#### Comment

These soil parameters were assumed for the purpose of demonstrating the analysis procedure. The designer should determine appropriate parameters based on a site-specific investigation.

**Wall situation:** Case 3: Retaining wall supporting building

**Surcharge:** The surcharge from the building was assumed to be  $5 \text{ KN/m}^2$  for the gravity case and  $4 \text{ KN/m}^2$  for the earthquake case, averaged across the active soil wedge. Surcharge should be calculated using:

$$w = 1.2 G + 0.4 Q \text{ for the gravity case}$$

$$w = G + 0.3 Q \text{ for the earthquake case.}$$

**Seismic parameters:** Site is assumed to be in the Christchurch Port Hills with Site Class C (shallow soil). For Site Class C in the Canterbury earthquake region for the ULS design case, 500 year return period:

$$a_{\max} = 0.4 g$$

$$A_{\text{topo}} = 1.0 \text{ assuming site is not near cliff edge or ridge top}$$

$$W_d = \text{wall displacement factor, given in Table 5.2 as } 0.5 \text{ (Case 3 from Table 4.1)}$$

Therefore, from Equation 5-1:

$$k_h = 0.4 \times 1.0 \times 0.5 = 0.2$$

#### Note

By adopting  $W_d = 0.5$  it is implicitly assumed that the wall and the retained ground are likely to yield and accumulate permanent displacement as a result of the design earthquake. Wall elements including the poles and anchor tendons must be sufficiently resilient and/or ductile to accommodate the displacement. Some settlement of retained material behind the wall should also be expected following a seismic event.

#### Step 1. Initial trial geometry

For the example assume that the pole spacing will be at 1.2 m centres and that the poles will be inserted into 500 mm diameter holes and backfilled with concrete. Typically, the pole spacing will be governed by the strength of the timber lagging.

**Step 2. Wall overturning (gravity case)**

For the gravity case, long term soil strength parameters are used, ie  $c = 0, \phi = 30^\circ$ . For this case, the method of Guo (2008) is recommended for calculating the pole lateral resistance as illustrated in Figure B.3. The foundation soil is assumed to be elastic-plastic, with the maximum lateral resistance in the plastic zone being given as:

$$P_u = A_r z B$$

in which:  $A_r = \gamma' K_p^2$

$B$  = diameter of the foundation

$\gamma'$  = effective soil unit weight

$K_p$  = Rankine coefficient of passive soil pressure

**Figure B.3: Lateral pile resistance in cohesionless soil as modelled by Guo (2008)**

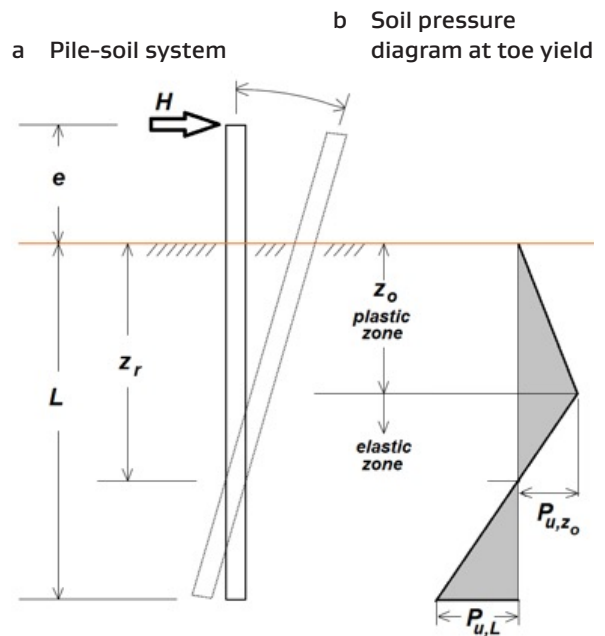

The following calculations are from Guo (2008) by making the simplifying assumption that soil modulus is uniform with depth:

Pole Wall Example for Module 6

$H_w := 2.5 \text{ m}$	Face height of wall
$S := 1.2 \text{ m}$	Pole spacing
$D_{hole} := 0.5 \cdot \text{m}$	Hole diameter (concrete filled)
$\phi_b := 35 \text{ deg}$	Soil friction angle, backfill
$\phi_n := 30 \text{ deg}$	Soil friction angle, native
$\gamma_b := 20 \frac{\text{kN}}{\text{m}^3}$	Soil unit weight, backfill
$\gamma_n := 18 \frac{\text{kN}}{\text{m}^3}$	Soil unit weight, native
$\omega := 5 \frac{\text{kN}}{\text{m}^2}$	Factored surcharge, de-stabilising (1.2G + 0.4 Q)

LRFD Parameters

$\Phi_p := 0.7$	Resistance factor for lateral pole resistance, gravity case
$\Phi_{p\_eq} := 1.0$	Resistance factor for lateral pole resistance, EQ case
$\alpha_{EP\_static} := 1.5$	Load factor for active earth pressure, gravity case
$\alpha_{EP\_eq} := 1.0$	Load factor for earth pressure, EQ case

Ka for backfill, using M-O (Coulomb) equations, gravity only case

$$\begin{aligned}
 k_h &:= 0.0 && \text{horizontal acceleration in g} && \theta := \text{atan}(k_h) && \theta = 0 \\
 \beta &:= 0 \cdot \text{deg} && \text{slope of the back of the wall} \\
 i &:= 0 \cdot \text{deg} && \text{slope of the backfill} \\
 \phi &:= \phi_b && \text{angle of internal friction, backfill} && \phi = 35 \text{ deg} \\
 \delta_i &:= \frac{2}{3} \cdot \phi && \text{angle of interface friction (for soil against rough sawn timber)}
 \end{aligned}$$

Calculation

$$D := \left( 1 + \left( \frac{\sin(\phi + \delta_i) \cdot \sin(\phi - \theta - i)}{\cos(\delta_i + \beta + \theta) \cdot \cos(i - \beta)} \right)^{0.5} \right)^2 \quad D = 2.99$$

$$K_A := \frac{\cos(\phi - \theta - \beta)^2}{\cos(\theta) \cdot \cos(\beta)^2 \cdot \cos(\beta + \delta_i + \theta)} \cdot D \quad K_A = 0.244$$

$$K_{AH} := \cos(\delta_i) \cdot K_A \quad K_{AH} = 0.224 \quad \text{Horizontal Component}$$

Active soil force acting on wall (per pole), moment at ground level, lever arm

$$F_{A\_star} := K_{AH} \cdot \left( \frac{1}{2} \cdot \gamma_b \cdot H_w^2 + \omega \cdot H_w \right) \cdot S \cdot \alpha_{EP\_static} = 30.3 \text{ kN}$$

$$M_{A\_star} := K_{AH} \cdot \left( \frac{1}{3} \cdot \frac{1}{2} \cdot \gamma_b \cdot H_w^3 + \frac{1}{2} \cdot \omega \cdot H_w^2 \right) \cdot S \cdot \alpha_{EP\_static} = 27.4 \text{ kN} \cdot \text{m}$$

$$e := \frac{M_{A\_star}}{F_{A\_star}} = 0.903 \text{ m}$$

Pole capacity using Guo 2008 (for cohesionless soils)  
(Assuming constant soil modulus with depth)  
(OK for relatively shallow, unsaturated soils)

$$L := 2.7 \cdot \text{m} \quad \text{Depth of embedment (trial and error)}$$

$$K_P := \frac{1 + \sin(\phi_n)}{1 - \sin(\phi_n)} = 3 \quad \text{Rankine passive pressure for foundation soil}$$

$$e_L := \frac{e}{L} = 0.33 \quad \text{Load eccentricity (normalised)}$$

$$z_{0L} := -(1.5 \cdot e_L + 0.5) + 0.5 \cdot \sqrt{5 + 12 \cdot e_L + 9 \cdot e_L^2} = 0.581 \quad \text{Depth of plastic zone (normalised, from Guo)}$$

$$H_{yd} := \frac{z_{0L}}{2 \cdot (2 + z_{0L} + 3 \cdot e_L)} = 0.081 \quad \text{Resistance at toe yield (normalised, from Guo)}$$

$$H_U := H_{yd} \cdot \gamma_n \cdot D_{hole} \cdot L^2 \cdot K_P^2 = 47.9 \text{ kN} \quad \text{Resistance at toe yield}$$

$$H_U := H_U \cdot 1.2 \quad \text{Adjustment for overburden effects (see Wood 2021)}$$

$$S_R := \frac{S}{D_{hole}} = 2.4 \quad \text{Pole spacing ratio}$$

$$R_S := 0.08 \cdot S_R + 0.6 = 0.79 \quad \text{Reduction factor for pole spacing (see Wood 2021)}$$

$$H_U := H_U \cdot R_S = 45.5 \text{ kN}$$

$$H_{U\_star} := H_U \cdot \Phi_p = 31.8 \text{ kN} \quad \text{check } > \quad F_{A\_star} = 30.3 \text{ kN} \quad \text{OK}$$

**Step 3. Wall overturning (earthquake case)**

Check that the depth of embedment of the poles is still adequate for the earthquake case. For the earthquake case (short term loading), the undrained shear strength of the foundation soil may be assumed for Port Hills loess when calculating the passive soil resistance,  $S_u = 50 \text{ KN/m}^2$  was assumed for the example.

For cohesive soils, the ultimate passive pressure acting against the pole is assumed to be proportional to the undrained shear strength of the soil and uniform with depth, but with a thickness of the near surface soil being ineffective. Wood (2021) recommends the following values:

$$P_u = 11 S_u B \quad z_t = 0.5 B$$

in which:  $P_u$  = limiting passive soil resistance against foundation (force per length)

$S_u$  = undrained shear strength of soil

$B$  = diameter of the foundation

$z_t$  = depth of ineffective soil layer:

**Figure B.4: Lateral pile resistance in cohesive soil as modelled by Motta (2013)**

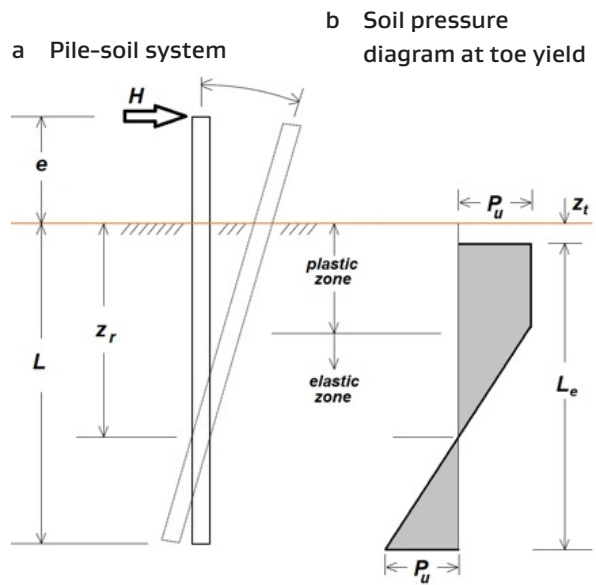

The following calculations are from Motta (2013).

Pole Wall Example for Module 6	
$H_w := 2.5 \text{ m}$	Face height of wall
$S := 1.2 \text{ m}$	Pole spacing
$D_{hole} := 0.5 \cdot \text{m}$	Hole diameter (concrete filled)
$\phi_b := 35 \text{ deg}$	Soil friction angle, backfill
$\phi_n := 30 \text{ deg}$	Soil friction angle, native
$S_u := 50 \cdot \frac{\text{kN}}{\text{m}^2}$	Soil undrained shear strength, native
$\gamma_b := 20 \cdot \frac{\text{kN}}{\text{m}^3}$	Soil unit weight, backfill
$\gamma_n := 18 \cdot \frac{\text{kN}}{\text{m}^3}$	Soil unit weight, native
$\omega := 4 \cdot \frac{\text{kN}}{\text{m}^2}$	Factored surcharge, de-stabilising (G + 0.3 Q) earthquake case

LRFD Parameters	
$\Phi_p := 0.7$	Resistance factor for lateral pole resistance, gravity case
$\Phi_{p\_eq} := 1.0$	Resistance factor for lateral pole resistance, EQ case
$\alpha_{EP\_static} := 1.5$	Load factor for active earth pressure, gravity case
$\alpha_{EP\_eq} := 1.0$	Load factor for earth pressure, EQ case



Ka for backfill, using M-O (Coulomb) equations, earthquake case

$$\begin{aligned}
 k_h &:= 0.2 && \text{horizontal acceleration in g} && \theta := \text{atan}(k_h) && \theta = 0.197 \\
 \beta &:= 0 \cdot \text{deg} && \text{slope of the back of the wall} \\
 i &:= 0 \cdot \text{deg} && \text{slope of the backfill} \\
 \phi &:= \phi_b && \text{angle of internal friction, backfill} && \phi = 35 \text{ deg} \\
 \delta_i &:= \frac{2}{3} \cdot \phi && \text{angle of interface friction (for soil against rough sawn timber)}
 \end{aligned}$$

Calculation

$$D := \left( 1 + \left( \frac{\sin(\phi + \delta_i) \cdot \sin(\phi - \theta - i)}{\cos(\delta_i + \beta + \theta) \cdot \cos(i - \beta)} \right)^{0.5} \right)^2 \quad D = 2.705$$

$$K_A := \frac{\cos(\phi - \theta - \beta)^2}{\cos(\theta) \cdot \cos(\beta)^2 \cdot \cos(\beta + \delta_i + \theta)} \cdot D \quad K_A = 0.384$$

$$K_{AH} := \cos(\delta_i) \cdot K_A \quad K_{AH} = 0.353 \quad \text{Horizontal Component}$$

Active soil force acting on wall (per pole), moment at ground level, lever arm

$$F_{A\_star} := K_{AH} \cdot \left( \frac{1}{2} \cdot \gamma_b \cdot H_w^2 + \omega \cdot H_w \right) \cdot S \cdot \alpha_{EP\_eq} = 30.7 \text{ kN}$$

$$M_{A\_star} := K_{AH} \cdot \left( \frac{1}{3} \cdot \frac{1}{2} \cdot \gamma_b \cdot H_w^3 + \frac{1}{2} \cdot \omega \cdot H_w^2 \right) \cdot S \cdot \alpha_{EP\_eq} = 27.3 \text{ kN} \cdot \text{m}$$

$$e := \frac{M_{A\_star}}{F_{A\_star}} = 0.89 \text{ m}$$

Pole capacity using Motta 2013 (for cohesive soils)

$$L := 2.7 \cdot \text{m} \quad \text{Depth of embedment (trial and error)}$$

$$P_u := 11 \cdot S_u \cdot D_{hole} = 275 \frac{\text{kN}}{\text{m}} \quad \text{Limiting pole resistance (Wood 2021)}$$

$$z_t := 0.5 \cdot D_{hole} = 0.25 \text{ m} \quad \text{Ineffective soil depth (Wood 2021)}$$

$$L_e := L - z_t = 2.45 \text{ m} \quad \text{Effective pile embedment depth}$$

$$e_d := \frac{(e + z_t)}{L_e} = 0.466 \quad \text{Effective load eccentricity, normalised}$$

$$H_{yd} := \frac{\sqrt{(3 \cdot e_d + 1)^2 + 2}}{2} - \frac{3 \cdot e_d + 1}{2} = 0.193 \quad \text{Lateral resistance at toe yield, normalised (Motta 2013)}$$

$$H_U := H_{yd} \cdot P_u \cdot L_e = 130.1 \text{ kN} \quad \text{Lateral resistance at toe yield}$$

$$S_R := \frac{S}{D_{hole}} = 2.4 \quad \text{Pole spacing ratio}$$

$$R_S := 0.08 \cdot S_R + 0.6 = 0.79 \quad \text{Reduction factor for pole spacing (see Wood 2021)}$$

$$H_U := H_U \cdot R_S = 103 \text{ kN}$$

$$H_{U\_star} := H_U \cdot \Phi_{p\_eq} = 103 \text{ kN} \quad \text{check} > \quad F_{A\_star} = 30.7 \text{ kN} \quad \text{OK}$$

## CHECK OF EMBEDMENT DEPTH

For the example, it was found that the depth of embedment determined for the gravity load case was also suitable for the earthquake load case ( $L = 2.7$  m).

### Step 4. Pole strength

The pole structural elements may fail in bending. For poles encased in concrete foundations bending failure is most likely to occur either at ground level, where the concrete encasement terminates, or below ground level at the depth of maximum bending moment if composite bending capacity of the concrete encased pole is considered. Both cases need to be checked. For poles embedded directly into soil, bending failure will occur below ground level at the depth of maximum bending moment.

Where there is a substantial concrete slab or other restraint at ground level, then pole bending will be critical at the location of the restraint. Bearing of the timber pole against the slab should also be checked in such cases.

#### Note

before such restraint may be assumed, it is necessary to establish a realistic load path for the necessary restraining forces..

For the example, pole bending moments are calculated at ground level, where the concrete encasement terminates, given as  $M_{A\_star}$  in the above example, and the pole strength should be checked for both the gravity and earthquake load cases. Recommendations for assessing the composite strength of concrete encased poles below ground level is given by Wood (2021). The bending moments below ground level may be calculated by reference to Figures B.3 and B.4.

## Appendix C. Worked example 2

### C.1 Design of concrete cantilever retaining walls to resist earthquake loading

Cantilever concrete retaining walls are commonly used for residential, commercial, and infrastructure purposes.

Where used as integral basement walls they are often buttressed by return walls and floor diaphragms which may make them too stiff for active soil pressures to develop requiring higher design loads and a different design approach.

The following worked example is for a free-standing cantilever wall that is considered sufficiently flexible for active soil pressures to be used for design.

#### C.1.1 POSSIBLE MODES OF FAILURE

Possible modes of failure for free-standing concrete cantilever retaining walls are illustrated in Figure C.1. A complete design should address each of these modes of failure where appropriate.

- a **Wall stem structural failure:** The wall stem fails in bending. Most likely location is at the base of the wall where the stem connects to the foundation.
- b **Foundation bearing failure:** A bearing failure of the soil under the toe of the foundation and a forwards rotation of the wall.
- c **Sliding failure of wall:** Possible mode for non-cohesive soils. Wall moves outwards with passive failure of soil in front of foundation and active failure of soil behind wall. Often a key is required beneath the foundation to prevent sliding.
- d **Deep seated rotational failure:** Possible mode for cohesive soils. Factor of safety controlled by increasing length of heel or depth of key. Factor of safety calculated using limiting equilibrium 'Bishop' analysis or similar. Unlikely to govern design unless wall is embedded into sloping ground with sloping backfill or there is a weak layer at the toe of the wall.

**Figure C.1: Possible modes of failure for free-standing concrete cantilever retaining walls**

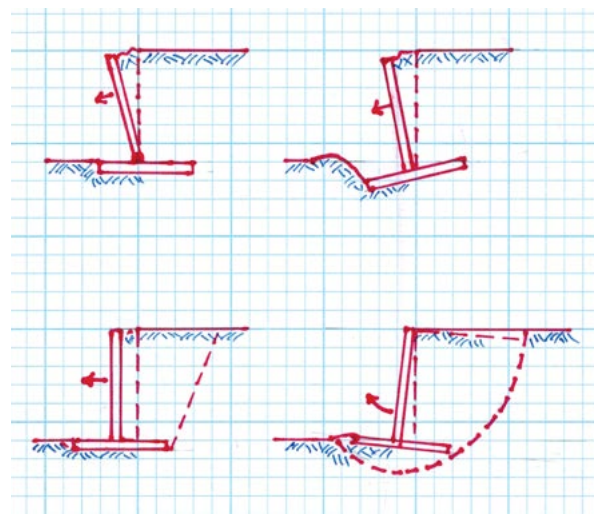

**Figure C.2: Concrete cantilever wall example**

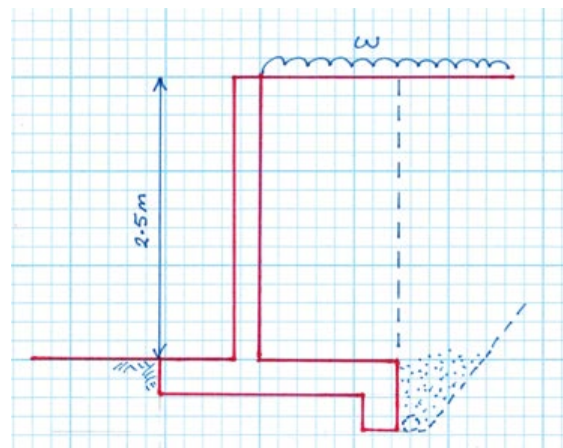

The following worked example uses a simplified LRFD design procedure with load and resistance factors taken from Module 4 of the *Guidelines*.

This procedure is intended to be readily calculated by hand, although use of calculation software such as Mathcad or Excel will be useful for design iterations. The example calculations are made here using Mathcad.

### C.1.2 EXAMPLE WALL

The example wall is shown in Figure B.2. The wall is assumed to be located in the Christchurch Port Hills. The following design assumptions were made:

- › **Soil type:** Port Hills loess
- › **Strength parameters:**  $c = 0$ ,  $f = 30^\circ$

Drained strength parameters for Port Hills loess were assumed for the long term, gravity only load case. For the earthquake load case, the foundations in loess were designed assuming undrained strength,  $c = 50 \text{ kN/m}^2$ ,  $f = 0^\circ$ .

#### Comment

These soil parameters were assumed for the purpose of demonstrating the analysis procedure. The designer should determine appropriate parameters based on a site specific investigation.

- › **Wall situation:** Case 3: Retaining wall downslope and supporting building foundations
- › **Surcharge:** The surcharge from the building was assumed to be  $5 \text{ kN/m}^2$  averaged across the active soil wedge for the gravity case and  $4 \text{ kN/m}^2$  for the earthquake case. Surcharge should be calculated using:
  - $w = 1.2 G + 0.4 Q$  for the gravity case
  - $w = G + 0.3 Q$  for the earthquake case.
- › **Seismic parameters:** Site is assumed to be in the Christchurch Port Hills with Site Class C (shallow soil). For Site Class C in the Canterbury earthquake region for the ULS design case, 500 year return period:

$$a_{\max} = 0.4 g$$

$$A_{\text{topo}} =$$

1.0 assuming site is not near cliff edge or ridge top

$W_d$  = wall displacement factor, given in Table 5.2 as 0.5 (Case 3 from Table 4.1)

Therefore, from Equation 5-1:

$$k_h = 0.4 \times 1.0 \times 0.5 = 0.2$$

#### Note:

By adopting  $W_d = 0.5$  it is implicitly assumed that the wall and the retained ground are likely to yield and accumulate permanent displacement during the design earthquake. Wall elements must be sufficiently resilient and/or ductile to accommodate the displacement. Some settlement of retained material behind the wall should also be expected following an earthquake.

Figure C.3: Analytical model used for gravity design of free-standing concrete cantilever wall (moments taken about point O)

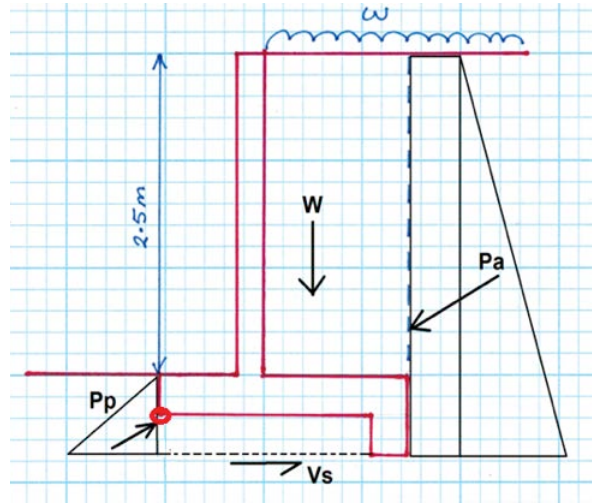
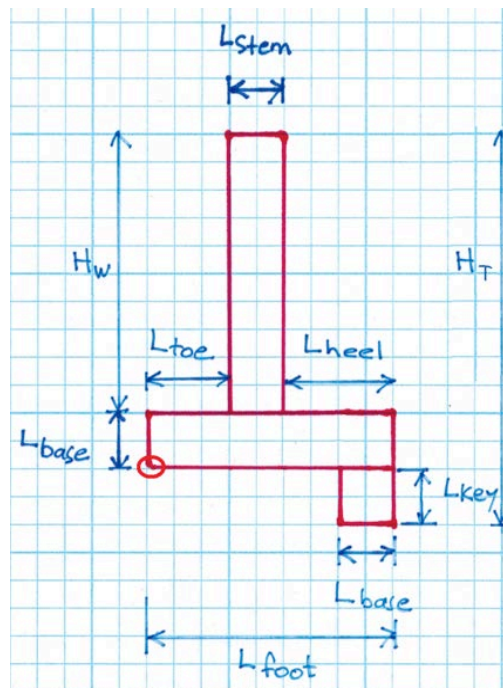

Figure C.4: Parameter definition



#### Step 1. Initial trial geometry

The main variables for geometry are the length of the toe, the length of the heel, and the depth of the key. These will be refined during the analysis below. The thickness of the wall stem and footing should be refined during the structural design process. The optimum location for the key is at the end of the heel, as shown in Figure C.2. The analytical model used for the design is illustrated in Figure C.3.

## Step 2. Foundation bearing (gravity case)

The foundation bearing capacity (gravity case) will usually govern the design of the wall dimensions and is checked first. The soil under the toe of the foundation in particular is working very hard to resist the vertical bearing loads, sliding shear, and to provide passive resistance to sliding.

For the following simplified procedure, the 'middle third rule' is applied, whereby the wall foundation is dimensioned so that the resultant vertical force acts through the 'middle third' of the footing. If the 'middle third rule' is not applied, then a more rigorous analysis of the bearing capacity of the wall foundation should be undertaken.

The bearing capacity of the foundation must be calculated taking into account the effect of simultaneous horizontal loads applied to the

foundation from the soil pressure (ie by applying load inclination factors), and using the reduced, effective width of the foundation from the eccentricity of the resultant vertical load.

Where there is confidence in the properties of the soil backfill in front of the toe of the footing, then the net horizontal load considered when calculating the load inclination factors for the bearing capacity may be reduced by the passive soil force acting against the footing (refer to Brinch-Hansen, 1970), in which case the depth factors must be set to 1.0 (ie the shear strength of the soil above the founding depth of the footing cannot be counted twice).

In the worked example, the passive soil resistance has been neglected (conservatively) when calculating the load inclination factors and bearing capacity, as follows.

### Conc cantilever wall parameters

$H_w := 2.5\text{-m}$	Height of wall
$L_{\text{stem}} := 0.2\text{-m}$	Thickness of wall stem
$L_{\text{toe}} := 0.65\text{-m}$	Length of toe
$L_{\text{base}} := 0.25\text{-m}$	Thickness of base
$L_{\text{heel}} := 1.0\text{-m}$	Length of heel
$L_{\text{key}} := 0.2\text{-m}$	Depth of shear key
$\phi := 30\text{-deg}$	Soil friction angle
$\gamma := 18 \frac{\text{kN}}{\text{m}^3}$	Soil unit weight
$\gamma_{\text{conc}} := 24.5 \frac{\text{kN}}{\text{m}^3}$	Concrete unit weight
$\omega_g := 5 \frac{\text{kN}}{\text{m}^2}$	Factored surcharge, gravity case, destabilising (1.2 G+ 0.4 Q)
$\omega_{gs} := 3 \frac{\text{kN}}{\text{m}^2}$	Factored surcharge, gravity case, stabilising (0.9 G)

### LRFD parameters

$\Phi_{bc} := 0.5$	Resistance factor for bearing capacity, gravity case
$\Phi_{sl} := 0.8$	Resistance factor for sliding, gravity case
$\Phi_p := 0.5$	Resistance factor for passive earth pressure, gravity case
$\alpha_{G_{\text{stab}}} := 0.9$	Load factor for self-weight (stabilising)
$\alpha_{G_{\text{destab}}} := 1.2$	Load factor for self-weight (de-stabilising)
$\alpha_{EP_{\text{static}}} := 1.5$	Load factor for earth pressure, gravity case (de-stabilising)

**Computed parameters**

$L_{\text{foot}} := L_{\text{toe}} + L_{\text{stem}} + L_{\text{heel}}$	$L_{\text{foot}} = 1.85 \text{ m}$	Width of footing
$H_T := H_W + L_{\text{base}} + L_{\text{key}}$	$H_T = 2.95 \text{ m}$	Total height of structure
$W_{\text{foot}} := L_{\text{foot}} \cdot L_{\text{base}} \cdot \gamma_{\text{conc}}$	$W_{\text{foot}} = 11.331 \cdot \frac{\text{kN}}{\text{m}}$	Weight of footing
$W_{\text{key}} := L_{\text{key}} \cdot L_{\text{base}} \cdot \gamma_{\text{conc}}$	$W_{\text{key}} = 1.225 \cdot \frac{\text{kN}}{\text{m}}$	Weight of key (same thickness as base)
$W_{\text{stem}} := H_W \cdot L_{\text{stem}} \cdot \gamma_{\text{conc}}$	$W_{\text{stem}} = 12.25 \cdot \frac{\text{kN}}{\text{m}}$	Weight of wall stem
$W_{\text{soil}} := L_{\text{heel}} \cdot H_W \cdot \gamma$	$W_{\text{soil}} = 45 \cdot \frac{\text{kN}}{\text{m}}$	Weight of soil above heel
$K_a := 0.3$	From MO equations (Coulomb) $\phi = 30$ degrees, $\delta = \phi$ , $i = 0$ degrees	
$K_p := 5.5$	From NAVFAC DM7 $\phi = 30$ degrees, $\delta = 2/3 \phi$	

**Note:**

A chart giving values of  $K_a$  and  $K_p$  based on the log-spiral solutions of Caquot and Kerisel is appended to this example.

**Check 'middle third rule'**

Factored moments about toe, divided by factored vertical forces neglecting passive resistance, which may not be mobilised.

$\delta_a := \phi$	Interface friction angle, wall virtual back face
$P_a := 0.5 K_a \cdot \gamma \cdot H_T^2$	$P_a = 23.497 \cdot \frac{\text{kN}}{\text{m}}$ Active thrust, soil weight component
$P_{av} := P_a \cdot \sin(\delta_a)$	$P_{ah} := P_a \cdot \cos(\delta_a)$ Vertical, horizontal components
$P_{a\omega} := \omega_g \cdot K_a \cdot H_T$	$P_{a\omega} = 4.425 \cdot \frac{\text{kN}}{\text{m}}$ Active thrust, surcharge component
$P_{av\omega} := P_{a\omega} \cdot \sin(\delta_a)$	$P_{ah\omega} := P_{a\omega} \cdot \cos(\delta_a)$ Vertical, horizontal components
$P_{\omega} := \omega_{gs} \cdot L_{\text{heel}}$	$P_{\omega} = 3 \cdot \frac{\text{kN}}{\text{m}}$ Surcharge above heel
$M_{ah} := \left[ P_{ah} \left( \frac{H_T}{3} - L_{\text{key}} \right) + P_{ah\omega} \left( \frac{H_T}{2} - L_{\text{key}} \right) \right] \cdot \alpha_{EP\_static}$	Moment from horizontal active pressure (+ve)
$M_{av} := (P_{av} + P_{av\omega}) \cdot L_{\text{foot}}$	Moment from vertical active pressure (-ve)
$M_{\omega} := P_{\omega} \left( L_{\text{foot}} - \frac{L_{\text{heel}}}{2} \right)$	Moment from surcharge above heel (-ve)
$M_G := \left[ W_{\text{foot}} \cdot \frac{L_{\text{foot}}}{2} + W_{\text{stem}} \left( L_{\text{toe}} + \frac{L_{\text{stem}}}{2} \right) + W_{\text{key}} \left( L_{\text{foot}} - \frac{L_{\text{key}}}{2} \right) + W_{\text{soil}} \left( L_{\text{foot}} - \frac{L_{\text{heel}}}{2} \right) \right] \cdot \alpha_{G\_stab}$	

^ Restoring moment from self weight of wall and soil above heel (-ve)

$$M_{ah} = 31.239 \cdot \frac{\text{kN} \cdot \text{m}}{\text{m}} \quad M_{av} = 25.828 \cdot \frac{\text{kN} \cdot \text{m}}{\text{m}} \quad M_G = 74.306 \cdot \frac{\text{kN} \cdot \text{m}}{\text{m}} \quad M_{\omega} = 4.05 \cdot \frac{\text{kN} \cdot \text{m}}{\text{m}}$$

$$M_{\text{net}} := M_{ah} - M_{av} - M_G - M_{\omega} \quad \text{Net moment about toe, neglecting passive thrust}$$

$$M_{\text{net}} = -72.945 \cdot \frac{\text{kN} \cdot \text{m}}{\text{m}} \quad \text{Net moment must be } < 0 \text{ for stability}$$

$$P_{\text{vert}} := (W_{\text{foot}} + W_{\text{stem}} + W_{\text{key}} + W_{\text{soil}}) \cdot \alpha_{G\_stab} + P_{av} + P_{av\omega} + P_{\omega}$$

$$P_{\text{vert}} = 79.787 \cdot \frac{\text{kN}}{\text{m}} \quad \text{Factored vertical load on footing}$$

$$L_{\text{net}} := \frac{-M_{\text{net}}}{P_{\text{vert}}} \quad L_{\text{net}} = 0.914 \text{ m} \quad \text{Line of action of net vertical force (distance from toe)}$$

$$L_{\text{third}} := \frac{1}{3} \cdot L_{\text{foot}} \quad L_{\text{third}} = 0.617 \text{ m} \quad 2 \cdot L_{\text{third}} = 1.233 \text{ m}$$

Adjust wall proportions until line of action is within "middle third"

**Note:**

The vertical component of active thrust is not factored (ie  $a = 1$ ). The horizontal component of active thrust is factored ( $a = 1.5$ ) to account for uncertainty of soil properties. But, uncertainty in soil properties does not significantly affect the vertical component which will remain about the same even if the actual soil friction angle is less than assumed.

The self-weight components are here factored down ( $\alpha = 0.9$ ) to account for uncertainty because they are 'stabilising' in this context, even though contributing to the vertical load on the footing.

Check bearing capacity

The 'effective' width of the footing must be established, together with the net horizontal and vertical loads acting on the following:

$$B_{\text{eff}} := 2 \cdot L_{\text{net}} \quad B_{\text{eff}} = 1.829 \text{ m} < L_{\text{foot}} = 1.85 \text{ m} \quad \text{Effective footing width (less than total width)}$$

$$V_{\text{u}} := P_{\text{vert}} \quad V_{\text{u}} = 79.787 \cdot \frac{\text{kN}}{\text{m}} \quad \text{Ultimate vertical load on footing}$$

$$H_{\text{u}} := (P_{\text{ah}} + P_{\text{ah}\omega}) \cdot \alpha_{\text{EP\_static}} \quad H_{\text{u}} = 36.271 \cdot \frac{\text{kN}}{\text{m}} \quad \text{Ultimate horizontal load on footing}$$

Detailed bearing capacity calculations are appended, and give the following result:

$$q_{\text{u}} = 91.968 \cdot \frac{\text{kN}}{\text{m}^2}$$

$$V_{\text{ustar}} := B_{\text{eff}} \cdot q_{\text{u}} \cdot \Phi_{\text{bc}} \quad V_{\text{ustar}} = 84.082 \cdot \frac{\text{kN}}{\text{m}} > V_{\text{u}} = 79.787 \cdot \frac{\text{kN}}{\text{m}}$$

$V_{\text{star}} > V_{\text{u}}$  therefore bearing capacity OK for gravity case.

**Step 3. Wall sliding (gravity case)**

The sliding analysis is carried out with reference to the model shown in Figure C.3. The weight of the block of soil underneath the footing and mobilised by the key is included in the calculation of base friction,  $V_{\text{s}}$ . All of the self-weight components are here factored *down* ( $\alpha = 0.9$ ) to account for uncertainty because they are 'stabilising' in this context.

The vertical component of active thrust is not factored (ie  $\alpha = 1$ ), as before. The vertical component of passive resistance is also not factored (ie  $\alpha = 1$ ) because it is 'de-stabilising' in this context.

Check wall sliding on base

$$W_{\text{slide}} := (L_{\text{foot}} - L_{\text{base}}) \cdot L_{\text{key}} \cdot \gamma \quad W_{\text{slide}} = 5.76 \cdot \frac{\text{kN}}{\text{m}} \quad \text{Weight of soil trapped under footing}$$

$$\delta_{\text{p}} := \frac{2}{3} \cdot \phi \quad \text{Interface friction angle for passive pressure}$$

$$P_{\text{p}} := 0.5 \cdot K_{\text{p}} \cdot \gamma \cdot (L_{\text{base}} + L_{\text{key}})^2 \quad P_{\text{p}} = 10.024 \cdot \frac{\text{kN}}{\text{m}} \quad \text{Passive resistance}$$

$$P_{\text{ph}} := P_{\text{p}} \cdot \cos(\delta_{\text{p}}) \quad P_{\text{pv}} := P_{\text{p}} \cdot \sin(\delta_{\text{p}}) \quad \text{Horizontal, vertical components}$$

$$H_{\text{s}} := (V_{\text{u}} + W_{\text{slide}} \cdot \alpha_{\text{G\_stab}} - P_{\text{pv}}) \cdot \tan(\phi) \quad H_{\text{s}} = 47.078 \cdot \frac{\text{kN}}{\text{m}} \quad \text{Friction under footing}$$

$$H_{\text{star}} := P_{\text{ph}} \cdot \Phi_{\text{p}} + H_{\text{s}} \cdot \Phi_{\text{sl}} \quad \text{Factored ultimate resistance}$$

$$H_{\text{star}} = 42.372 \cdot \frac{\text{kN}}{\text{m}} \quad H_{\text{u}} = 36.271 \cdot \frac{\text{kN}}{\text{m}}$$

Factored resistance > factored load therefore OK.

**Step 4. Wall stem bending strength (gravity case)**

The wall stem may fail in bending. The maximum bending moment will be at the base of the stem and may be calculated using the analytical model shown in Figure C.5. The surcharge above the heel is included as a worst case. The calculation of the bending strength of the wall should be carried out in accordance with the relevant material code.

Calculate maximum bending moment in wall stem

Assume that wall has waterproof membrane with padding, ie negligible interface friction.

$$\delta_s := 0$$

$$K_{as} := 0.33 \quad \text{From MO equations (Coulomb) } \phi = 30 \text{ degrees, } \delta = 0, i = 0$$

$$P_{as} := 0.5 \cdot K_{as} \cdot \gamma \cdot H_w^2 \quad P_{as} = 18.563 \cdot \frac{\text{kN}}{\text{m}} \quad \text{Active thrust}$$

$$P_{ahs} := P_{as} \cdot \cos(\delta_s) \quad \text{Horizontal component}$$

$$P_{aws} := \omega_g \cdot K_{as} \cdot H_w \quad P_{aws} = 4.125 \cdot \frac{\text{kN}}{\text{m}} \quad \text{Active thrust, surcharge component}$$

$$P_{ahws} := P_{aws} \cdot \cos(\delta_s) \quad \text{Horizontal component}$$

$$M_u := \left( P_{ahs} \cdot \frac{H_w}{3} + P_{ahws} \cdot \frac{H_w}{2} \right) \cdot \alpha_{EP\_static} \quad \text{Ultimate bending moment in stem}$$

$$M_u = 30.938 \cdot \frac{\text{kN} \cdot \text{m}}{\text{m}}$$

The bending capacity of the wall stem under action  $M_u$  needs to be checked using the relevant material code.

**Step 5. Foundation bearing (earthquake case)**

The foundation bearing capacity is checked for the earthquake case using the same geometry developed for the gravity case and including the earthquake inertia loads from the self-weight of the wall and from the soil above the heel according to the analytical model shown in Figure C.6.

For the earthquake case, the undrained shear strength of the foundation soil may be assumed as appropriate when calculating the passive soil resistance. For the example,  $S_u = 50 \text{ kN/m}^2$  was assumed. The passive soil distribution is shown in Figure C.6 with the cohesive contribution =  $2c$  where  $c = S_u$  and  $K_p = 1$  for  $f = 0$ .

Where the ground surface immediately in front of the wall is exposed, the passive resistance may be ineffective near to the ground surface because of desiccation and cracking and disturbance during excavation of the footing. For the example, the cohesive component of passive resistance was neglected down to the base of the concrete footing. For other situations where the ground surface is protected by pavement it may be appropriate to include the cohesive component of passive soil resistance over the full depth of embedment, using judgement.

**Figure C.5: Analytical model for calculating bending moment in wall stem**

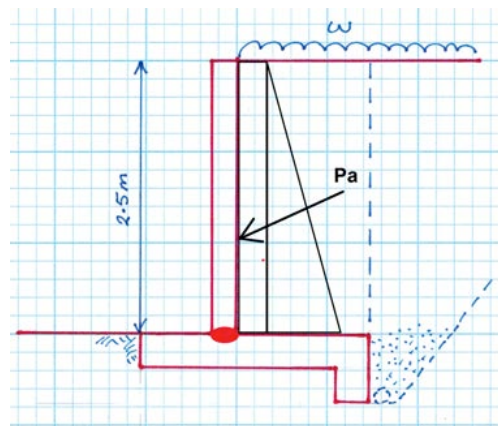

**Figure C.6: Analytical model for earthquake case**

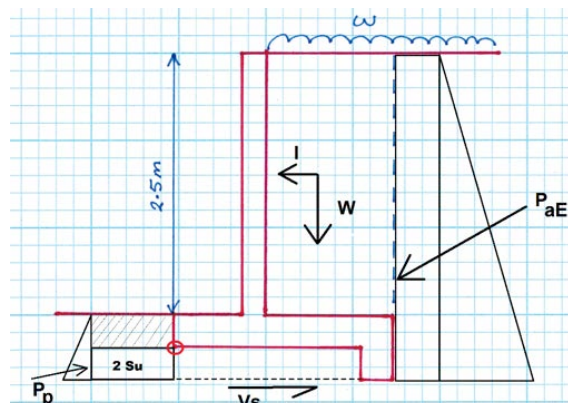



Using the same simplified procedure as for the gravity case, the 'middle third rule' is again checked.

The bearing capacity of the foundation, again, must be calculated taking into account the effect of simultaneous horizontal loads applied to the foundation from the soil pressure (ie by applying load inclination factors), and using the reduced,

effective width of the foundation from the eccentricity of the resultant vertical load. For the earthquake case, the LRFD parameters are all set to unity, as discussed in the guidelines, assuming (for this example) that the foundation soil will not be subject to strength loss during earthquake shaking or strain softening as a result of soil yielding.

$\omega_{eq} := 4 \cdot \frac{kN}{m^2}$	Factored surcharge, EQ, destabilising (G + Eu + 0.3Q)
$\omega_{gs} := 3 \cdot \frac{kN}{m^2}$	Factored surcharge, stabilising (0.9 G)
$k_h := 0.2$	Seismic coefficient

LRFD parameters

All set to 1.0

$K_{aE} := 0.471$  From M-O equations  $k_h = 0.2$ ,  $\phi = 30$  degrees,  $\delta = \phi$ ,  $i = 0$  degrees

Check 'middle third rule'

Factored moments about rotation point, divided by factored vertical forces neglecting passive resistance, which may not be mobilised.

$\delta_a := \phi$	Interface friction angle, wall virtual back face
$P_a := 0.5 \cdot K_{aE} \cdot \gamma \cdot H_T^2$	$P_a = 36.89 \cdot \frac{kN}{m}$ Active thrust, soil weight component
$P_{av} := P_a \cdot \sin(\delta_a)$	$P_{ah} := P_a \cdot \cos(\delta_a)$ Vertical, horizontal components
$P_{a\omega} := \omega_{eq} \cdot K_{aE} \cdot H_T$	$P_{a\omega} = 5.558 \cdot \frac{kN}{m}$ Active thrust, surcharge component
$P_{av\omega} := P_{a\omega} \cdot \sin(\delta_a)$	$P_{ah\omega} := P_{a\omega} \cdot \cos(\delta_a)$ Vertical, horizontal components
$P_\omega := \omega_{gs} \cdot L_{heel}$	$P_\omega = 3 \cdot \frac{kN}{m}$ Surcharge above heel

The inertia of the wall structural elements and soil located above the heel (treated as part of the wall) are added, as follows:

$I_{foot} := W_{foot} \cdot k_h$	$I_{key} := W_{key} \cdot k_h$	$I_{stem} := W_{stem} \cdot k_h$	$I_{soil} := W_{soil} \cdot k_h$	Inertia forces, structure
$M_{ah} := \left[ P_{ah} \left( \frac{H_T}{3} - L_{key} \right) + P_{ah\omega} \left( \frac{H_T}{2} - L_{key} \right) \right]$				Moment from horizontal components (+ve)
$M_{av} := (P_{av} + P_{av\omega}) \cdot L_{foot}$				Moment from vertical components (-ve)
$M_\omega := P_\omega \left( L_{foot} - \frac{L_{heel}}{2} \right)$				Moment from surcharge above heel (-ve)
$M_I := (I_{stem} + I_{soil}) \left( \frac{H_w}{2} + L_{base} \right) + I_{foot} \cdot \frac{L_{base}}{2} - I_{key} \cdot \frac{L_{key}}{2}$ Moment from inertia forces (+ve)				

The restoring moment from the self-weight of the wall and soil above the heel is calculated as follows without any load factor applied.

$$M_G := \left[ W_{\text{foot}} \cdot \frac{L_{\text{foot}}}{2} + W_{\text{stem}} \cdot \left( L_{\text{toe}} + \frac{L_{\text{stem}}}{2} \right) + W_{\text{key}} \cdot \left( L_{\text{foot}} - \frac{L_{\text{key}}}{2} \right) + W_{\text{soil}} \cdot \left( L_{\text{foot}} - \frac{L_{\text{heel}}}{2} \right) \right]$$

$$M_{\text{ah}} = 31.162 \cdot \frac{\text{kN}\cdot\text{m}}{\text{m}} \quad M_{\text{av}} = 39.264 \cdot \frac{\text{kN}\cdot\text{m}}{\text{m}} \quad M_I = 17.434 \cdot \frac{\text{kN}\cdot\text{m}}{\text{m}} \quad M_{\omega} = 4.05 \cdot \frac{\text{kN}\cdot\text{m}}{\text{m}}$$

$$M_G = 82.563 \cdot \frac{\text{kN}\cdot\text{m}}{\text{m}}$$

$$M_{\text{net}} := M_{\text{ah}} + M_I - M_{\text{av}} - M_{\omega} - M_G \quad \text{Net moment about toe, neglecting passive thrust}$$

$$M_{\text{net}} = -77.281 \cdot \frac{\text{kN}\cdot\text{m}}{\text{m}} \quad \text{Net moment must be } < 0 \text{ for stability}$$

$$P_{\text{vert}} := W_{\text{foot}} + W_{\text{stem}} + W_{\text{key}} + W_{\text{soil}} + P_{\text{av}} + P_{\text{av}\omega} + P_{\omega}$$

$$P_{\text{vert}} = 94.03 \cdot \frac{\text{kN}}{\text{m}} \quad \text{Net vertical load on footing}$$

$$L_{\text{net}} := \frac{-M_{\text{net}}}{P_{\text{vert}}} \quad L_{\text{net}} = 0.822 \text{ m} \quad \text{Line of action of net vertical force (distance from toe)}$$

$$L_{\text{third}} := \frac{1}{3} \cdot L_{\text{foot}} \quad L_{\text{third}} = 0.617 \text{ m} \quad 2 \cdot L_{\text{third}} = 1.233 \text{ m}$$

Adjust wall proportions until line of action is within "middle third"

So the line of action of the net vertical force on the wall footing is still within the 'middle third'.

#### Check bearing capacity

The 'effective' width of the footing must be established, together with the net horizontal and vertical loads acting on the footing:

$$B_{\text{eff}} := 2 \cdot L_{\text{net}} \quad B_{\text{eff}} = 1.644 \text{ m} < L_{\text{foot}} = 1.85 \text{ m} \quad \text{Effective footing width}$$

$$V_{\text{ueq}} := P_{\text{vert}} \quad V_{\text{ueq}} = 94.03 \cdot \frac{\text{kN}}{\text{m}} \quad \text{Ultimate vertical load on footing}$$

$$H_{\text{ueq}} := P_{\text{ah}} + P_{\text{ah}\omega} + I_{\text{stem}} + I_{\text{soil}} + I_{\text{foot}} + I_{\text{key}} \quad \text{Ultimate horizontal load on footing}$$

$$H_{\text{ueq}} = 50.722 \cdot \frac{\text{kN}}{\text{m}}$$

Detailed bearing capacity calculations are appended, and give the following result:

$$q_u = 223.059 \cdot \frac{\text{kN}}{\text{m}^2}$$

$$V_{\text{ustar}} := B \cdot q_u \cdot \phi_{\text{bc}} \quad V_{\text{ustar}} = 366.651 \cdot \frac{\text{kN}}{\text{m}} > V_{\text{ueq}} = 94.03 \cdot \frac{\text{kN}}{\text{m}}$$

$V_{\text{star}} > V_u$  therefore bearing capacity OK for earthquake case.

#### Step 6. Wall sliding (earthquake case)

The sliding analysis is carried out with reference to the model shown in Figure C.3. The cohesive component of passive soil resistance in front of the toe of the wall was neglected because of possible desiccation and disturbance. None of the components of load or resistance are factored for the earthquake case.

#### Check wall sliding on base

$$K_p := 1 \quad \text{For } \phi = 0$$

$$P_p := 0.5 \cdot K_p \cdot \gamma \cdot (L_{\text{base}} + L_{\text{key}})^2 + 2 \cdot S_u \cdot L_{\text{key}} \quad P_p = 21.823 \cdot \frac{\text{kN}}{\text{m}} \quad \text{Ultimate passive resistance}$$

$$H_{\text{star}} := P_p + c_a \cdot B_{\text{eff}} \quad H_{\text{star}} = 104.01 \cdot \frac{\text{kN}}{\text{m}} \quad \text{Ultimate sliding resistance}$$

$$H_{\text{star}} = 104.01 \cdot \frac{\text{kN}}{\text{m}} > H_{\text{ueq}} = 50.722 \cdot \frac{\text{kN}}{\text{m}}$$

$H_{\text{star}} > H_{\text{ueq}}$  therefore design OK.

**Step 7. Wall stem bending strength (earthquake case)**

The wall stem may fail in bending. The maximum bending moment will be at the base of the stem and may be calculated using the analytical model shown in Figure C.7. In this case the active earthquake pressure from the soil is added to the inertia of the wall stem. The calculation of the bending strength of the wall should be carried out in accordance with the relevant material code.

The bending capacity of the wall stem under action  $M_u$  needs to be checked using the relevant material code.

**Figure C.7: Analytical model for calculating bending moment in wall stem (earthquake case)**

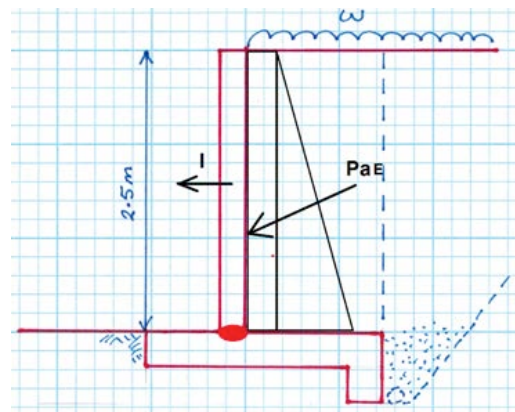

Calculate maximum bending moment in wall stem

Assume that wall has waterproof membrane with padding, ie negligible interface friction.

$$\delta_s := 0$$

$$K_{aEs} := 0.473$$

From M-O equations  $\phi = 30$  degrees,  $\delta = 0$ ,  $i = 0$

$$P_{as} := 0.5 \cdot K_{aE} \cdot \gamma \cdot H_w^2$$

$$P_{as} = 26.494 \cdot \frac{\text{kN}}{\text{m}}$$

Active thrust

$$P_{ahs} := P_{as} \cdot \cos(\delta_s)$$

Horizontal component

$$P_{a\omega s} := \omega_{eq} \cdot K_{aE} \cdot H_w$$

$$P_{a\omega s} = 4.71 \cdot \frac{\text{kN}}{\text{m}}$$

Active thrust, surcharge component

$$P_{ah\omega s} := P_{a\omega s} \cdot \cos(\delta_s)$$

Horizontal component

$$M_u := P_{ahs} \cdot \frac{H_w}{3} + P_{ah\omega s} \cdot \frac{H_w}{2} + I_{\text{stem}} \cdot \frac{H_w}{2}$$

Ultimate bending moment in stem

$$M_u = 31.028 \text{ kN} \cdot \frac{\text{m}}{\text{m}}$$

Detailed bearing capacity calculations:

### Drained bearing capacity shallow footing — Vesic

$B := B_{\text{eff}}$	$L := 10\text{-m}$	$D := L_{\text{base}}$	Footing dimensions (effective)
$\beta := 0\text{-deg}$			Ground slope in front of footing
$\eta := 0\text{-deg}$			Tilt of footing (refer diagram)
$c_s := 0 \frac{\text{kN}}{\text{m}^2}$			Soil effective cohesion
$c_a := 1.0\text{-c}$			Adhesion (underside of footing)
$q := \gamma \cdot D$			Surcharge

$$N_q := e^{\pi \cdot \tan(\phi)} \cdot \left( \tan\left(\frac{\phi}{2} + \frac{\pi}{4}\right) \right)^2 \quad N_c := (N_q - 1) \cdot \cot(\phi) \quad N_\gamma := 2(N_q + 1) \cdot \tan(\phi)$$

$$N_q = 18.401 \quad N_c = 30.14 \quad N_\gamma = 22.402$$

Shape factors

$$\lambda_{cs} := 1 + \frac{B \cdot N_q}{L \cdot N_c} \quad \lambda_{\gamma s} := 1 - 0.4 \frac{B}{L} \quad \lambda_{qs} := 1 + \frac{B \cdot \tan(\phi)}{L}$$

$$\lambda_{cs} = 1.112 \quad \lambda_{\gamma s} = 0.927 \quad \lambda_{qs} = 1.106$$

Depth factors ( $D < B$ )

$$\lambda_{qd} := 1 + 2 \cdot \tan(\phi) \cdot (1 - \sin(\phi)) \cdot \frac{D}{B} \quad \lambda_{cd} := \lambda_{qd} - \frac{1 - \lambda_{qd}}{N_c \cdot \tan(\phi)}$$

$$\lambda_{cd} = 1.042 \quad \lambda_{qd} = 1.039 \quad \lambda_{\gamma d} := 1$$

Load inclination factors (loading parallel to B)

$$n_B := \frac{2 + \frac{B}{L}}{1 + \frac{B}{L}} \quad n_B = 1.845$$

$$\lambda_{qi} := \left( 1 - \frac{H_u \cdot L}{V_u \cdot L + L \cdot B \cdot c_a \cdot \cot(\phi)} \right)^{n_B} \quad \lambda_{qi} = 0.327$$

$$\lambda_{\gamma i} := \left( 1 - \frac{H_u}{V_u + L \cdot B \cdot c_a \cdot \cot(\phi)} \right)^{n_B + 1} \quad \lambda_{\gamma i} = 0.178$$

$$\lambda_{ci} := \lambda_{qi} - \frac{1 - \lambda_{qi}}{N_c \cdot \tan(\phi)} \quad \lambda_{ci} = 0.288$$

Ground inclination factors (see diagram)

$$\lambda_{qg} := (1 - \tan(\beta))^2 \quad \lambda_{cg} := \lambda_{qg} - \frac{1 - \lambda_{qg}}{N_c \cdot \tan(\phi)} \quad \lambda_{\gamma g} := \lambda_{qg}$$

$$\lambda_{qg} = 1 \quad \lambda_{cg} = 1 \quad \lambda_{\gamma g} = 1$$

Base tilt factors (see diagram)

$$\lambda_{qt} := (1 - \eta \cdot \tan(\phi))^2 \quad \lambda_{ct} := \lambda_{qt} - \frac{1 - \lambda_{qt}}{N_c \cdot \tan(\phi)} \quad \lambda_{\gamma t} := \lambda_{qt}$$

$$\lambda_{qt} = 1 \quad \lambda_{ct} = 1 \quad \lambda_{\gamma t} = 1$$

Ultimate bearing pressure

$$q_u := c \cdot \lambda_{cs} \cdot \lambda_{cd} \cdot \lambda_{ci} \cdot \lambda_{cg} \cdot \lambda_{ct} \cdot N_c + q \cdot \lambda_{qs} \cdot \lambda_{qd} \cdot \lambda_{qi} \cdot \lambda_{qg} \cdot \lambda_{qt} \cdot N_q + \frac{1}{2} \cdot \gamma \cdot B \cdot \lambda_{\gamma s} \cdot \lambda_{\gamma d} \cdot \lambda_{\gamma i} \cdot \lambda_{\gamma g} \cdot \lambda_{\gamma t} \cdot N_\gamma$$

$$q_u = 91.968 \frac{\text{kN}}{\text{m}^2}$$

$$V_{\text{ustar}} := B_{\text{eff}} \cdot q_u \cdot \Phi_{bc} \quad V_{\text{ustar}} = 84.082 \frac{\text{kN}}{\text{m}} > V_u = 79.787 \frac{\text{kN}}{\text{m}}$$

**Undrained bearing capacity shallow footing — Vesic**

$S_u := 50 \cdot \frac{\text{kN}}{\text{m}^2}$	$\phi_u := 0$	$c_u := S_u$	$\gamma_u := 18 \frac{\text{kN}}{\text{m}^3}$	Soil parameters (undrained)
$B := B_{\text{eff}}$	$L := 10\text{-m}$	$D := L_{\text{base}}$		Footing dimensions (effective)
$\beta := 0\text{-deg}$				Ground slope in front of footing
$\eta := 0\text{-deg}$				Tilt of footing (refer diagram)
$\Phi_{bc} := 1.0$				Bearing capacity resistance factor
$c_a := 1.0\text{-c}$				Adhesion (underside of footing)
$q := \gamma \cdot D$				Surcharge
$N_c := 5.14$	$N_q := 1$	$N_\gamma := 0$		Bearing capacity factors

Shape factors

$$\lambda_{cs} := 1 + \frac{B \cdot N_q}{L \cdot N_c} \quad \lambda_{\gamma s} := 1 - 0.4 \cdot \frac{B}{L} \quad \lambda_{qs} := 1 + \frac{B \cdot \tan(\phi)}{L} \quad \lambda_{cs} = 1.0; \lambda_{\gamma s} = 0.934 \quad \lambda_{qs} = 1$$

Depth factors

$$\lambda_{qd} := 1 + 2 \cdot \tan(\phi) \cdot (1 - \sin(\phi))^2 \cdot \frac{D}{B} \quad \lambda_{cd} := 1 + 0.4 \cdot \frac{D}{B} \quad \lambda_{\gamma d} := 1 \quad \lambda_{qd} = 1 \quad \lambda_{cd} = 1.061$$

Load inclination factors (loading parallel to B)

$$n := \frac{2 + \frac{B}{L}}{1 + \frac{B}{L}} \quad \lambda_{ci} := 1 - \frac{n \cdot H_{ueq} \cdot L}{c_a \cdot N_c \cdot B \cdot L} \quad \lambda_{ci} = 0.777 \quad \lambda_{\gamma i} := 1 \quad \lambda_{qi} := 1$$

Ground inclination factors

$$\lambda_{cg} := 1 - \frac{2 \cdot \beta}{\pi + 2} \quad \lambda_{qg} := (1 - \tan(\beta))^2 \quad \lambda_{\gamma g} := \lambda_{qg} \quad \lambda_{qg} = 1 \quad \lambda_{cg} = 1$$

$$N_{\gamma g} := -2 \cdot \sin(\beta) \quad N_\gamma = 0$$

Base tilt factors

$$\lambda_{ct} := 1 - \frac{2 \cdot \eta}{\pi + 2} \quad \lambda_{ct} = 1 \quad \lambda_{\gamma t} := 1 \quad \lambda_{qt} := 1$$

Ultimate bearing pressure

$$q_u := c \cdot \lambda_{cs} \cdot \lambda_{cd} \cdot \lambda_{ci} \cdot \lambda_{cg} \cdot \lambda_{ct} \cdot N_c + q \cdot \lambda_{qs} \cdot \lambda_{qd} \cdot \lambda_{qi} \cdot \lambda_{qg} \cdot \lambda_{qt} \cdot N_q + \frac{1}{2} \cdot \gamma \cdot B \cdot \lambda_{\gamma s} \cdot \lambda_{\gamma d} \cdot \lambda_{\gamma i} \cdot \lambda_{\gamma g} \cdot \lambda_{\gamma t} \cdot N_\gamma$$

$$q_u = 223.059 \cdot \frac{\text{kN}}{\text{m}^2}$$

$$V_{ustar} := B \cdot q_u \cdot \Phi_{bc} \quad V_{ustar} = 366.651 \cdot \frac{\text{kN}}{\text{m}} > \quad V_{ueq} = 94.03 \cdot \frac{\text{kN}}{\text{m}}$$

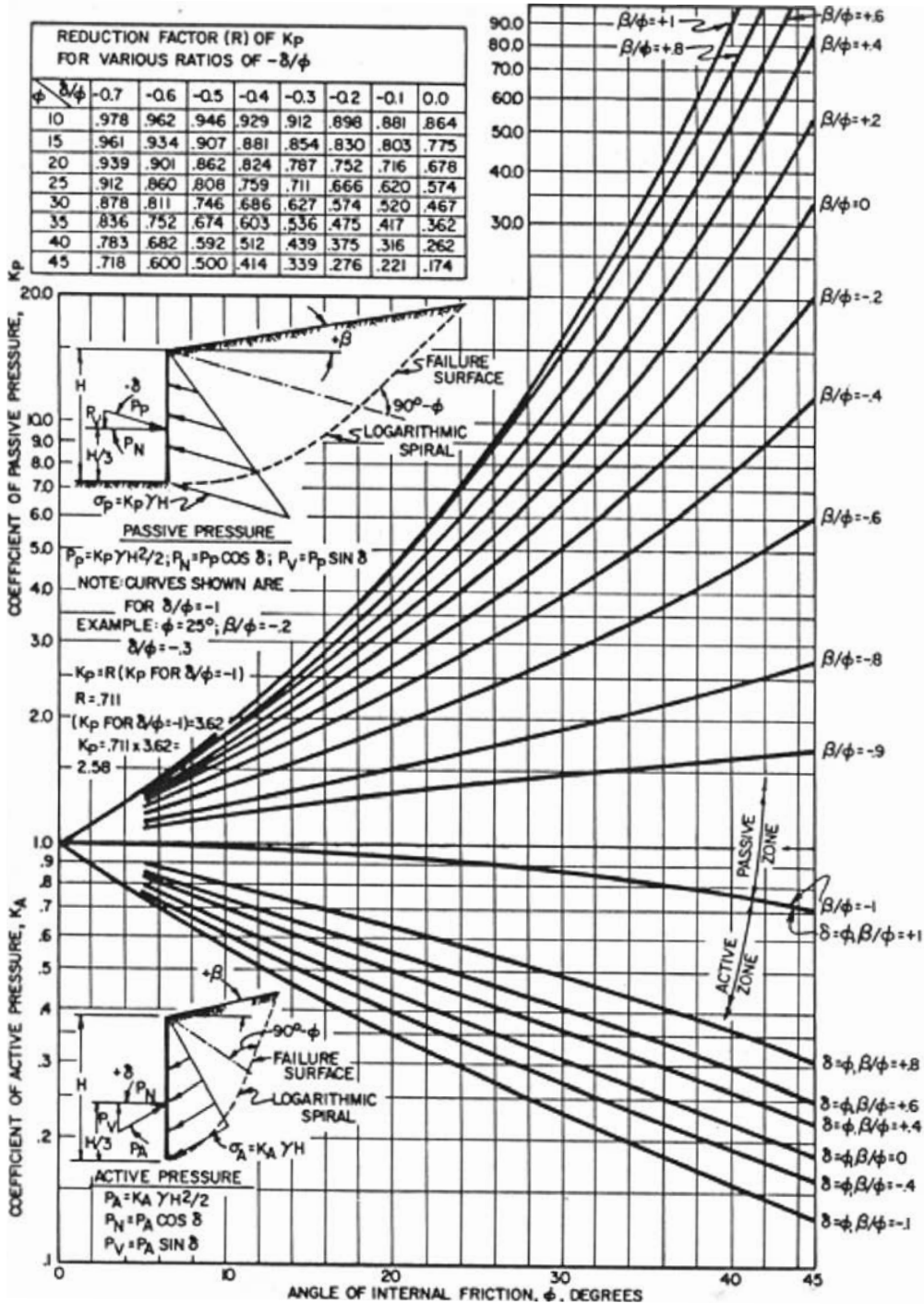

**References**

Bowles, J.E. (1997) Foundation Analysis and Design, Fifth Edition, McGraw-Hill, New York, 1175 p

Brinch-Hansen, J (1970). A revised and extended formula for bearing capacity, Bulletin No. 28, Danish Geotechnical Institute, Copenhagen

Pender, M J (2015) 'Moment and Shear Capacity of Shallow Foundations

at Fixed Vertical Load'. Proc., 12th Australia New Zealand Conference on Geomechanics, Wellington

Vesic, A.S. (1975) Chap. 3, Foundation Engineering Handbook, 1st. Ed., edited by Winterkorn and Fang, Van Nostrand Reinhold, 751 p

## Appendix D. Worked example 3

### D.1 Design of concrete crib retaining walls to resist earthquake loading

Concrete crib and timber crib retaining walls are a type of gravity wall which comprises a system of interlocking header and stretcher blocks to retain granular fill that provides the necessary stabilising mass to the wall.

Crib walls are commonly used in New Zealand for purposes such as stabilising building platforms, cut batters, and driveway access. They are very adaptable and can be straight, curved, or angled and incorporate landscape features if required. Heights typically vary from 2 m to 12 m. Crib walls are able to sustain differential settlement. They have been proven over many decades of use in New Zealand.

There was quite a wide variation in seismic performance observed for crib walls during the Canterbury earthquake sequence. It appears that this variability is much more strongly influenced by construction details and practice rather than fundamental design. A particular construction issue was the use of rounded gravel fill within the wall units. Rounded material tends to shake out leaving voids between the block units and settlement of the ground or pavements above the wall. Angular, crushed rock filling should always be used and separated from finer grained soils by good quality filter fabric.

The following worked example is for a typical concrete crib retaining wall supporting a cut slope face on the up-slope side of a building. The design analysis is based on a conventional gravity wall analysis in which the wall and soil encapsulated by the crib units is assumed to act as a rigid block.

#### D.1.1 POSSIBLE MODES OF FAILURE

Possible modes of failure for crib retaining walls are illustrated in Figure D.1. A complete design should address each of these modes of failure where appropriate.

- a **Foundation bearing failure:** A bearing failure of the soil under the toe of the foundation and a forwards rotation of the wall. Crib walls should be built on concrete pad foundations at least as wide as the crib units. Crib walls are usually constructed on a 4V:1H batter that greatly improves the overall stability of the wall and reduces the eccentricity of loading on the foundation pad.
- b **Internal shear failure of wall:** The design of the interlocking crib units is intended to provide a high resistance to internal shear failure, together with the use of good quality angular, crushed rock filling.
- c **Crushing failure of crib units:** Crushing of crib units is possible under high overturning loads.
- d **Sliding failure of wall:** Possible mode for non-cohesive soils. Wall moves outwards with passive failure of soil in front of foundation and active failure of soil behind wall. If necessary, a key can be added beneath the foundation to improve sliding resistance.
- e **Deep seated rotational failure:** Possible mode for cohesive soils. Factor of safety calculated using limiting equilibrium 'Bishop' analysis or similar. Unlikely to govern design unless wall is embedded into sloping ground with sloping backfill or there is a weak layer at the toe of the wall.

**Figure D.1: Possible modes of failure for crib retaining walls**

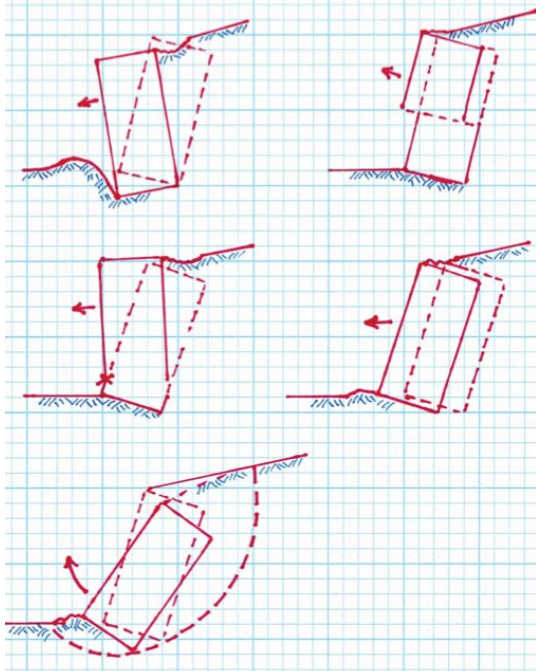

**Figure D.2: Concrete crib wall example**

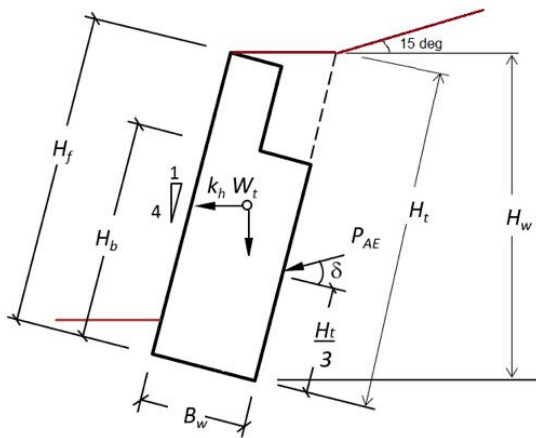

The following worked example uses a simplified LRFD design procedure with load and resistance factors taken from Module 4 of the *Guidelines*.

This procedure is intended to be readily calculated by hand, although use of calculation software such as Mathcad or Excel will be useful for design iterations. The example calculations are made here using Mathcad.

### D.1.2 EXAMPLE WALL

The analysis definition for a double-tier type crib wall is shown in Figure D.2. The wall was assumed to be constructed on a concrete strip footing of the same width as the wall. The wall is assumed to be located in the Christchurch Port Hills and supporting a cut batter on the up-slope side of a building (Case 4 in the *Guidelines*).

The following design assumptions were made:

- › **Soil type:** Port Hills loess
- › **Strength parameters:**  $c = 0$ ,  $f = 30^\circ$

Drained strength parameters for Port Hills loess were assumed for the long term, gravity only load case. For the earthquake load case, the foundations in loess were designed assuming undrained strength,  $c = 50 \text{ kN/m}^2$ ,  $f = 0^\circ$ .

#### Comment

These soil parameters were assumed for the purpose of demonstrating the analysis procedure. The designer should determine appropriate parameters based on a site specific investigation.

- › **Wall situation:** Case 4: Retaining wall protecting building up-slope
- › **Surcharge:** No surcharge is assumed
- › **Back-slope:** A back-slope angle of  $15^\circ$  is assumed
- › **Seismic parameters:** Site is assumed to be in the Christchurch Port Hills with Site Class C (shallow soil). For Site Class C in the Canterbury earthquake region for the ULS design case, 500 year return period:

$$a_{\max} = 0.4 \text{ g}$$

$$A_{\text{topo}} =$$

1.0 assuming site is not near cliff edge or ridge top

$W_d$  = wall displacement factor, given in Table 5.2 as 0.4 (Case 4 from Table 4.1)

Therefore, from Equation 5-1:

$$k_h = 0.4 \times 1.0 \times 0.4 = 0.16$$

#### Note:

By adopting  $W_d = 0.4$  it is implicitly assumed that the wall and the retained ground are likely to yield and accumulate permanent displacement during the design earthquake. Wall elements must be sufficiently resilient and/or ductile to accommodate the displacement. Some settlement of retained material behind the wall should also be expected following an earthquake.



### Step 1. Initial trial geometry

The main variables for geometry are defined in Figure D.2 with the trial values given below:

$H_f := 4.5\text{-m}$	Slope height of wall
$B_w := 2.2\text{-m}$	Width of footing
$\eta := \text{atan}\left(\frac{1}{4}\right)$	Wall slope angle
$i := 15\text{-deg}$	Backfill slope angle
$\phi := 30\text{-deg}$	Soil friction angle
$\delta_a := 0.67 \cdot \phi$	Interface friction angle, wall virtual back face
$\gamma := 18 \cdot \frac{\text{KN}}{\text{m}^3}$	Soil unit weight
$\gamma_{\text{wall}} := 18 \cdot \frac{\text{KN}}{\text{m}^3}$	Average unit weight of wall units and backfill

### Step 2. Foundation bearing (gravity case)

The foundation bearing capacity (gravity case) will usually govern the design of the wall dimensions and is checked first. The soil under the toe of the foundation in particular is working very hard to resist the vertical bearing loads, sliding shear, and to provide passive resistance to sliding.

For the example, the footing is assumed to be 200 mm thick and embedded flush with the ground surface.

For the following simplified procedure, the 'middle third rule' is applied, whereby the wall foundation is dimensioned so that the resultant force acts through the 'middle third' of the footing. If the 'middle third rule' is not applied, then a more rigorous analysis of the bearing capacity of the wall foundation should be undertaken (eg Pender, 2015).

The foundation of the crib wall is tilted at an angle of 1V:4H and so it is convenient to resolve all forces acting on the wall to components acting either perpendicular to the back face of the wall or parallel to the wall instead of vertical and horizontal.

The bearing capacity of the foundation must be calculated taking into account the effect of simultaneous horizontal loads applied to the foundation from the soil pressure (ie by applying load inclination factors), and using the reduced, effective width of the foundation from the eccentricity of the resultant vertical load. Where there is confidence in the properties of the soil backfill in front of the toe of the footing, then the net horizontal load considered when calculating the load inclination factors for the bearing capacity may be reduced by the passive soil force acting against the footing (refer to Brinch-Hansen, 1970), in which case the depth factors must be set to 1.0 (ie the shear strength of the soil above the founding depth of the footing cannot be counted twice). In the worked example, the passive soil resistance has been neglected (conservatively) when calculating the load inclination factors and bearing capacity.

The bearing capacity of the foundation is also affected by the tilt of the footing and so tilt factors are applied (see detailed bearing capacity calculations appended to the example):

#### LRFD parameters

$\Phi_{bc} := 0.5$	Resistance factor for bearing capacity, gravity case
$\Phi_{sl} := 0.8$	Resistance factor for sliding, gravity case
$\Phi_p := 0.5$	Resistance factor for passive earth pressure, gravity case
$\alpha_{G\_stab} := 0.9$	Load factor for self-weight (stabilising)
$\alpha_{G\_destab} := 1.2$	Load factor for self-weight (de-stabilising)
$\alpha_{EP\_static} := 1.5$	Load factor for earth pressure, gravity case (de-stabilising)

**Computed parameters**

$H_s := B_w \cdot \tan(\eta)$	$H_s = 0.55 \text{ m}$	
$H_t := H_f + H_s$	$H_t = 5.05 \text{ m}$	Length of wall backface
$H_w := H_t \cdot \cos(\eta)$	$H_w = 4.899 \text{ m}$	Height of wall (projected)
$W_1 := H_f \cdot B_w \cdot \gamma_{\text{wall}}$	$W_1 = 178.2 \cdot \frac{\text{KN}}{\text{m}}$	Weight, virtual wall
$W_2 := 0.5 \cdot B_w \cdot H_s \cdot \gamma$	$W_2 = 10.89 \cdot \frac{\text{KN}}{\text{m}}$	Weight, soil wedge
$K_a := 0.253$	From M-O eqns. $k_h=0, \phi = 30 \text{ deg}, \delta = 2\phi/3, i = 15 \text{ deg}, \beta = -14 \text{ deg}$	

**Check 'middle third rule'**

Factored moments about toe, divided by factored perpendicular forces neglecting passive resistance, which may not be mobilised.

$P_a := 0.5 \cdot K_a \cdot \gamma \cdot H_w^2$	$P_a = 54.653 \cdot \frac{\text{KN}}{\text{m}}$	Active thrust, soil weight
$P_{aT} := P_a \cdot \cos(\delta_a)$	$P_{aT} = 51.325 \cdot \frac{\text{KN}}{\text{m}}$	Perpendicular component
$P_{aL} := P_a \cdot \sin(\delta_a)$	$P_{aL} = 18.782 \cdot \frac{\text{KN}}{\text{m}}$	Parallel component
$M_{aT} := \left( P_{aT} \cdot \frac{H_t}{3} \right) \cdot \alpha_{EP\_static}$	$M_{aT} = 129.595 \cdot \frac{\text{KN}\cdot\text{m}}{\text{m}}$	Moment, perpendicular active pressure (+ve)
$M_{aL} := P_{aL} \cdot B_w$	$M_{aL} = 41.321 \cdot \frac{\text{KN}\cdot\text{m}}{\text{m}}$	Moment, parallel active pressure (-ve)
$M_{G1} := W_1 \left( \cos(\eta) \cdot \frac{B_w}{2} + \sin(\eta) \cdot \frac{H_f}{2} \right) \cdot \alpha_{G\_stab}$	$M_{G1} = 258.671 \cdot \frac{\text{KN}\cdot\text{m}}{\text{m}}$	
$M_{G2} := W_2 \left[ \cos(\eta) \cdot \frac{2 \cdot B_w}{3} + \sin(\eta) \cdot \left( H_f + \frac{H_s}{3} \right) \right] \cdot \alpha_{G\_stab}$	$M_{G2} = 25.078 \cdot \frac{\text{KN}\cdot\text{m}}{\text{m}}$	

$M_{G1}, M_{G2}$  = Restoring moments from self weight of wall and soil above (-ve)

(See Figure D.3 for definition of  $W_1$  and  $W_2$ ).

**Figure D.3: Virtual wall used for analysis, showing  $W_1$  and  $W_2$**

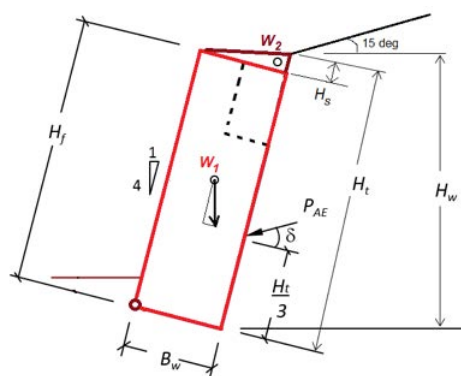

$$M_{\text{net}} := M_{aT} - M_{aL} - M_{G1} - M_{G2}$$

$$M_{\text{net}} = -195.475 \cdot \frac{\text{KN}\cdot\text{m}}{\text{m}} \quad \text{Net moment must be } < 0 \text{ for stability}$$

$$P_T := (W_1 + W_2) \cdot \cos(\eta) \cdot \alpha_{G\_stab} + P_{aL}$$

$$P_T = 183.882 \cdot \frac{\text{KN}}{\text{m}} \quad \text{Factored net perpendicular load on footing}$$

$$L_{\text{net}} := \frac{-M_{\text{net}}}{P_T} \quad L_{\text{net}} = 1.063 \text{ m} \quad \text{Net moment about toe, neglecting passive thrust}$$

$$L_{\text{third}} := \frac{1}{3} \cdot B_w \quad L_{\text{third}} = 0.733 \text{ m} \quad 2 \cdot L_{\text{third}} = 1.467 \text{ m}$$

Adjust wall proportions until line of action is within "middle third"

**Note:**  
 The parallel component (ie parallel to the back face of the wall) of active thrust is not factored (ie  $a = 1$ ).  
 The perpendicular component of active thrust is factored ( $a = 1.5$ ) to account for uncertainty of soil properties. But, uncertainty in soil properties does not significantly affect the parallel component which will remain about the same even if the actual soil friction angle is less than assumed.

The self-weight components are here factored down ( $a = 0.9$ ) to account for uncertainty because they are 'stabilising' in this context, even though contributing to the load on the footing.

### Check bearing capacity

The 'effective' width of the footing must be established, together with the net perpendicular and parallel loads acting on the footing:

$$B_{\text{eff}} := 2 \cdot L_{\text{net}} \quad B_{\text{eff}} = 2.126 \text{ m} \quad \text{Effective footing width (not wider than footing)}$$

$$V_{\text{u}} := P_{\text{T}} \quad V_{\text{u}} = 183.882 \cdot \frac{\text{KN}}{\text{m}} \quad \text{Ultimate perpendicular load on footing}$$

$$H_{\text{u}} := P_{\text{aT}} \cdot \alpha_{\text{EP\_static}} - (W_1 + W_2) \cdot \sin(\eta) \cdot \alpha_{\text{G\_stab}} \quad \text{Ultimate parallel load on footing}$$

$$H_{\text{u}} = 35.712 \cdot \frac{\text{KN}}{\text{m}}$$

Detailed bearing capacity calculations are appended, and give the following result:

$$q_{\text{u}} = 197.333 \cdot \frac{\text{KN}}{\text{m}^2} \quad \text{Ultimate bearing pressure}$$

$$V_{\text{star}} := q_{\text{u}} \cdot B_{\text{eff}} \cdot \phi_{\text{bc}} \quad V_{\text{star}} = 209.774 \cdot \frac{\text{KN}}{\text{m}} \quad V_{\text{u}} = 183.882 \cdot \frac{\text{KN}}{\text{m}}$$

$V_{\text{star}} > V_{\text{u}}$  therefore bearing capacity OK for gravity case.

### Step 3. Wall sliding on base (gravity case)

The sliding analysis is carried out with reference to the model shown in Figure D.3. All of the self-weight components are here factored down ( $\alpha = 0.9$ ) to account for uncertainty because they are 'stabilising' in this context.

The passive resistance of the soil acting against the front of the foundation pad is neglected as being comparatively small in this example.

### Check wall sliding on base

$$H_{\text{star}} := V_{\text{u}} \cdot \tan(\phi) \cdot \phi_{\text{s1}} \quad \text{Factored ultimate resistance (friction under footing)}$$

$$H_{\text{star}} = 84.931 \cdot \frac{\text{KN}}{\text{m}} \quad H_{\text{u}} = 35.712 \cdot \frac{\text{KN}}{\text{m}}$$

Factored resistance > factored load therefore OK.

### Step 4. Foundation bearing (earthquake case)

The foundation bearing capacity is checked for the earthquake case using the same geometry developed for the gravity case and including the earthquake inertia loads from the self-weight of the wall according to the analytical model shown in Figure D.3.

For the earthquake case, the undrained shear strength of the foundation soil may be assumed as appropriate.

For the example,  $S_{\text{u}} = 50 \text{ KN/m}^2$  was assumed for Port Hills Loess.

Using the same simplified procedure as for the gravity case, the 'middle third rule' is again checked.

For the earthquake case, the LRFD parameters are all set to unity, as discussed in the guidelines, assuming that the loess foundation soil will not be subject to strength loss during earthquake shaking or strain softening as a result of soil yielding.

$$K_{\text{aE}} := 0.439 \quad \text{From M-O eqns. } k_{\text{n}}=0.16, \phi = 30 \text{ deg}, \delta = 2\phi/3, i = 15 \text{ deg}, \beta = -14 \text{ deg}$$

Check 'middle third rule'

Factored moments about toe, divided by factored perpendicular forces neglecting passive resistance, which may not be mobilised.

$P_a := 0.5 \cdot K_{aE} \cdot \gamma \cdot H_w^2$	$P_a = 94.833 \cdot \frac{\text{KN}}{\text{m}}$	Active thrust, soil weight
$P_{aT} := P_a \cdot \cos(\delta_a)$	$P_{aT} = 89.057 \cdot \frac{\text{KN}}{\text{m}}$	Perpendicular component
$P_{aL} := P_a \cdot \sin(\delta_a)$	$P_{aL} = 32.59 \cdot \frac{\text{KN}}{\text{m}}$	Parallel component
$I_{1T} := k_h \cdot W_1 \cdot \cos(\eta)$	$I_{1T} = 27.661 \cdot \frac{\text{KN}}{\text{m}}$	Inertia of wall , perpendicular compt.
$I_{2T} := k_h \cdot W_2 \cdot \cos(\eta)$	$I_{2T} = 1.69 \cdot \frac{\text{KN}}{\text{m}}$	Inertia of soil wedge , perpendicular compt.
$I_{1L} := k_h \cdot W_1 \cdot \sin(\eta)$	$I_{1L} = 6.915 \cdot \frac{\text{KN}}{\text{m}}$	Inertia of wall , parallel compt.
$I_{2L} := k_h \cdot W_2 \cdot \sin(\eta)$	$I_{2L} = 0.423 \cdot \frac{\text{KN}}{\text{m}}$	Inertia of soil wedge , parallel compt.
$M_{aT} := \left( P_{aT} \cdot \frac{H_f}{3} \right)$	$M_{aT} = 149.913 \cdot \frac{\text{KN}\cdot\text{m}}{\text{m}}$	Moment, perpendicular active pressure (+ve)
$M_{aL} := P_{aL} \cdot B_w$	$M_{aL} = 71.699 \cdot \frac{\text{KN}\cdot\text{m}}{\text{m}}$	Moment, parallel active pressure (-ve)
$M_{I1} := I_{1T} \cdot \frac{H_f}{2} - I_{1L} \cdot \frac{B_w}{2}$	$M_{I1} = 54.63 \cdot \frac{\text{KN}\cdot\text{m}}{\text{m}}$	Moment, inertia of wall
$M_{I2} := I_{2T} \cdot \left( H_f + \frac{H_s}{3} \right) - I_{2L} \cdot \frac{2 \cdot B_w}{3}$	$M_{I2} = 7.297 \cdot \frac{\text{KN}\cdot\text{m}}{\text{m}}$	Moment, inertia of wall
$M_{G1} := W_1 \cdot \left( \cos(\eta) \cdot \frac{B_w}{2} + \sin(\eta) \cdot \frac{H_f}{2} \right)$	$M_{G1} = 287.412 \cdot \frac{\text{KN}\cdot\text{m}}{\text{m}}$	
$M_{G2} := W_2 \cdot \left[ \cos(\eta) \cdot \frac{2 \cdot B_w}{3} + \sin(\eta) \cdot \left( H_f + \frac{H_s}{3} \right) \right]$	$M_{G2} = 27.865 \cdot \frac{\text{KN}\cdot\text{m}}{\text{m}}$	
$M_{G1}, M_{G2} =$ Restoring moments from self weight of wall and soil above (-ve)		
$M_{\text{net}} := M_{aT} + M_{I1} + M_{I2} - M_{aL} - M_{G1} - M_{G2}$		
$M_{\text{net}} = -175.136 \cdot \frac{\text{KN}\cdot\text{m}}{\text{m}}$	Net moment must be < 0 for stability	
$V_u := (W_1 + W_2) \cdot \cos(\eta) + P_{aL} + I_{1L} + I_{2L}$		
Factored net perpendicular load on footing Net moment about toe, neglecting passive thrust		
$V_u = 223.372 \cdot \frac{\text{KN}}{\text{m}}$		
$L_{\text{net}} := \frac{-M_{\text{net}}}{V_u}$	$L_{\text{net}} = 0.784 \text{ m}$	Line of action of net vertical force (distance from toe)
$L_{\text{third}} := \frac{1}{3} \cdot B_w$	$L_{\text{third}} = 0.733 \text{ m}$	$2 \cdot L_{\text{third}} = 1.467 \text{ m}$

Adjust wall proportions until line of action is within "middle third"

The line of action of the force perpendicular to the wall footing is still within the 'middle third'.

**Check bearing capacity**

The 'effective' width of the footing must be established, together with the net perpendicular and parallel loads acting on the following:

$$B_{\text{eff}} := 2 \cdot L_{\text{net}} \quad B_{\text{eff}} = 1.568 \text{ m} \quad \text{Effective footing width (not wider than footing)}$$

$$V_u = 223.372 \cdot \frac{\text{KN}}{\text{m}} \quad \text{Ultimate perpendicular load on footing}$$

$$H_u := P_{aT} + I_{1T} + I_{2T} - (W_1 + W_2) \cdot \sin(\eta) \quad \text{Ultimate parallel load on footing}$$

$$H_u = 72.547 \cdot \frac{\text{KN}}{\text{m}}$$

Detailed bearing capacity calculations are appended, and give the following result:

$$q_u = 164.032 \cdot \frac{\text{KN}}{\text{m}^2} \quad \text{Ultimate bearing pressure}$$

$$V_{\text{star}} := q_u \cdot B_{\text{eff}} \quad V_{\text{star}} = 257.22 \cdot \frac{\text{KN}}{\text{m}} > V_u = 223.372 \cdot \frac{\text{KN}}{\text{m}}$$

$V_{\text{star}} > V_u$  therefore bearing capacity OK for earthquake case.

**Step 6. Wall sliding (earthquake case)**

The sliding analysis is carried out with reference to the model shown in Figure D.2. The passive soil resistance in front of the toe of the wall was neglected because of possible desiccation and disturbance. The adhesion underneath the footing is assumed to be the full undrained shear strength of the soil (eg concrete poured in contact with rough ground surface).

$$H_{\text{star}} := B_{\text{eff}} \cdot c_a \quad \text{Ultimate sliding resistance}$$

$$H_{\text{star}} = 78.405 \cdot \frac{\text{KN}}{\text{m}} > H_u = 72.547 \cdot \frac{\text{KN}}{\text{m}}$$

**Other issues**

The external stability (global stability) of the wall may need to be checked in certain cases, eg where the ground in front of the retaining wall is sloping away. Also where there is weak ground below or in front of the toe of the wall.

**Drained bearing capacity shallow footing — Vesic**

$$\begin{aligned}
 B &:= B_{\text{eff}} & L &:= 30\text{-m} & D &:= 0.2\text{-m} & & \text{Footing dimensions (effective)} \\
 \beta &:= 0\text{-deg} & & & & & & \text{Ground slope in front of footing} \\
 c_a &:= 0 \frac{\text{KN}}{\text{m}^2} & & & & & & \text{Soil cohesion} \\
 c_a &:= 1 \cdot c & & & & & & \text{Adhesion (underside of footing)} \\
 q &:= \gamma \cdot D & & & & & & \text{Surcharge}
 \end{aligned}$$

$$N_q := e^{\pi \cdot \tan(\phi)} \left( \tan\left(\frac{\phi}{2} + \frac{\pi}{4}\right) \right)^2 \quad N_c := (N_q - 1) \cdot \cot(\phi) \quad N_\gamma := 2 \cdot (N_q + 1) \cdot \tan(\phi)$$

$$N_q = 18.401 \quad N_c = 30.14 \quad N_\gamma = 22.402$$

**Shape factors**

$$\lambda_{cs} := 1 + \frac{B \cdot N_q}{L \cdot N_c} \quad \lambda_{\gamma s} := 1 - 0.4 \frac{B}{L} \quad \lambda_{qs} := 1 + \frac{B \cdot \tan(\phi)}{L}$$

$$\lambda_{cs} = 1.043 \quad \lambda_{\gamma s} = 0.972 \quad \lambda_{qs} = 1.041$$

**Depth factors (D < B)**

$$\lambda_{qd} := 1 + 2 \cdot \tan(\phi) \cdot (1 - \sin(\phi))^2 \frac{D}{B} \quad \lambda_{cd} := \lambda_{qd} - \frac{1 - \lambda_{qd}}{N_c \cdot \tan(\phi)}$$

$$\lambda_{cd} = 1.029 \quad \lambda_{qd} = 1.027 \quad \lambda_{\gamma d} := 1$$

**Load inclination factors (loading parallel to B)**

$$n_B := \frac{2 + \frac{B}{L}}{1 + \frac{B}{L}} \quad n_B = 1.934$$

$$\lambda_{qi} := \left( 1 - \frac{H_u \cdot L}{V_u \cdot L + L \cdot B \cdot c_a \cdot \cot(\phi)} \right)^{n_B} \quad \lambda_{qi} = 0.659$$

$$\lambda_{\gamma i} := \left( 1 - \frac{H_u \cdot L}{V_u \cdot L + L \cdot B \cdot c_a \cdot \cot(\phi)} \right)^{n_B + 1} \quad \lambda_{\gamma i} = 0.531$$

$$\lambda_{ci} := \lambda_{qi} - \frac{1 - \lambda_{qi}}{N_c \cdot \tan(\phi)} \quad \lambda_{ci} = 0.639$$

**Ground inclination factors (see diagram)**

$$\lambda_{qg} := (1 - \tan(\beta))^2 \quad \lambda_{cg} := \lambda_{qg} - \frac{1 - \lambda_{qg}}{N_c \cdot \tan(\phi)} \quad \lambda_{\gamma g} := \lambda_{qg}$$

$$\lambda_{qg} = 1 \quad \lambda_{cg} = 1 \quad \lambda_{\gamma g} = 1$$

**Base tilt factors (see diagram)**

$$\lambda_{qt} := (1 - \eta \cdot \tan(\phi))^2 \quad \lambda_{ct} := \lambda_{qt} - \frac{1 - \lambda_{qt}}{N_c \cdot \tan(\phi)} \quad \lambda_{\gamma t} := \lambda_{qt}$$

$$\lambda_{qt} = 0.737 \quad \lambda_{ct} = 0.722 \quad \lambda_{\gamma t} = 0.737$$

**Ultimate bearing pressure**

$$q_u := c \cdot \lambda_{cs} \cdot \lambda_{cd} \cdot \lambda_{ci} \cdot \lambda_{cg} \cdot \lambda_{ct} \cdot N_c + q \cdot \lambda_{qs} \cdot \lambda_{qd} \cdot \lambda_{qi} \cdot \lambda_{qg} \cdot \lambda_{qt} \cdot N_q + \frac{1}{2} \cdot \gamma \cdot B \cdot \lambda_{\gamma s} \cdot \lambda_{\gamma d} \cdot \lambda_{\gamma i} \cdot \lambda_{\gamma g} \cdot \lambda_{\gamma t} \cdot N_\gamma$$

$$q_u = 197.333 \frac{\text{KN}}{\text{m}^2} \quad \text{Ultimate bearing pressure}$$

$$V_{\text{star}} := q_u \cdot B_{\text{eff}} \cdot \Phi_{bc} \quad V_{\text{star}} = 209.774 \frac{\text{KN}}{\text{m}} \quad V_u = 183.882 \frac{\text{KN}}{\text{m}}$$

**Undrained bearing capacity shallow footing — Vesic**

$S_u := 50 \frac{\text{KN}}{\text{m}^2}$	$s_u := S_u$	Cohesion = undrained shear strength
$c_a := 1.0 \cdot S_u$		Adhesion (underside of footing)
$B := B_{\text{eff}}$	$L := 30 \cdot \text{m}$	Dimensions of footing
$D := 0.2 \cdot \text{m}$		Depth of footing
$q := \gamma \cdot D$		Surcharge
$\beta := 0 \cdot \text{deg}$		Ground slope in front of footing
$N_c := 5.14$	$N_q := 1$	$N_\gamma := 0$
		Bearing capacity factors

**Shape factors**

$$\lambda_{cs} := 1 + \frac{B \cdot N_q}{L \cdot N_c} \quad \lambda_{\gamma s} := 1 - 0.4 \cdot \frac{B}{L} \quad \lambda_{qs} := 1 + \frac{B \cdot \tan(\phi)}{L} \quad \lambda_{cs} = 1.0; \lambda_{\gamma s} = 0.979 \quad \lambda_{qs} = 1.03$$

**Depth factors**

$$\lambda_{qd} := 1 + 2 \cdot \tan(\phi) \cdot (1 - \sin(\phi))^2 \cdot \frac{D}{B} \quad \lambda_{cd} := 1 + 0.4 \cdot \frac{D}{B} \quad \lambda_{\gamma d} := 1 \quad \lambda_{qd} = 1.037 \quad \lambda_{cd} = 1.051$$

**Load inclination factors (loading parallel to B)**

$$n := \frac{2 + \frac{B}{L}}{1 + \frac{B}{L}} \quad \lambda_{ci} := 1 - \frac{n \cdot H_u \cdot L}{c_a \cdot N_c \cdot B \cdot L} \quad \lambda_{ci} = 0.649 \quad \lambda_{\gamma i} := 1 \quad \lambda_{qi} := 1$$

**Ground inclination factors**

$$\lambda_{cg} := 1 - \frac{2 \cdot \beta}{\pi + 2} \quad \lambda_{qg} := (1 - \tan(\beta))^2 \quad \lambda_{\gamma g} := \lambda_{qg} \quad \lambda_{qg} = 1 \quad \lambda_{cg} = 1$$

$$N_{\gamma g} := -2 \cdot \sin(\beta) \quad N_\gamma = 0$$

**Base tilt factors**

$$\lambda_{ct} := 1 - \frac{2 \cdot \eta}{\pi + 2} \quad \lambda_{ct} = 0.905 \quad \lambda_{\gamma t} := 1 \quad \lambda_{qt} := 1$$

**Ultimate bearing pressure**

$$q_u := c \cdot \lambda_{cs} \cdot \lambda_{cd} \cdot \lambda_{ci} \cdot \lambda_{cg} \cdot \lambda_{ct} \cdot N_c + q \cdot \lambda_{qs} \cdot \lambda_{qd} \cdot \lambda_{qi} \cdot \lambda_{qg} \cdot \lambda_{qt} \cdot N_q + \frac{1}{2} \cdot \gamma \cdot B \cdot \lambda_{\gamma s} \cdot \lambda_{\gamma d} \cdot \lambda_{\gamma i} \cdot \lambda_{\gamma g} \cdot \lambda_{\gamma t} \cdot N_\gamma$$

$$q_u = 164.032 \frac{\text{KN}}{\text{m}^2} \quad \text{Ultimate bearing pressure}$$

$$V_{\text{star}} := q_u \cdot B_{\text{eff}} \quad V_{\text{star}} = 257.22 \frac{\text{KN}}{\text{m}} > V_u = 223.372 \frac{\text{KN}}{\text{m}}$$

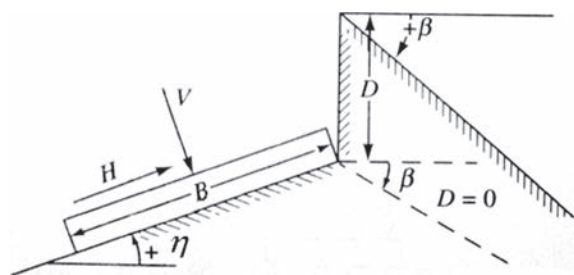

[Source: Bowles 1997]

**References**

Bowles, J.E. (1997) Foundation Analysis and Design, Fifth Edition, McGraw-Hill, New York, 1175 p.

Brinch-Hansen, J (1970). A revised and extended formula for bearing capacity, Bulletin No. 28, Danish Geotechnical Institute, Copenhagen.

Pender, M J (2015) 'Moment and Shear Capacity of Shallow Foundations at Fixed Vertical Load'. Proc., 12th Australia New Zealand Conference on Geomechanics, Wellington.

Vesic, A.S. (1975) Chap. 3, Foundation Engineering Handbook, 1st. Ed., edited by Winterkorn and Fang, Van Nostrand Reinhold, 751 p.

## Appendix E. Worked example 4

### E.1 Design of a tied-back retaining wall to resist earthquake loading

Tied-back retaining walls were used originally as a substitute for braced retaining walls in deep excavations. Ground anchor tie-backs were used to replace bracing struts that caused congestion and construction difficulty within the excavation.

Design procedures evolved from those developed for braced excavations and are typically based on the so-called 'apparent earth pressure' diagrams of Terzaghi and Peck (1967) and Peck (1969). These diagrams were developed empirically from measurements of loads imposed on bracing struts during deep excavations in sands in Berlin, Munich, and New York; in soft to medium insensitive glacial clays in Chicago; and in soft to medium insensitive marine clays in Oslo.

These original 'apparent earth pressure diagrams' were not intended by the authors to be a realistic representation of actual earth pressures against a wall but to be '...merely an artifice for calculating values of the strut loads that will not be exceeded in any real strut in a similar open cut. In general, the bending moments in the sheeting or soldier piles, and in wales and lagging, will be substantially smaller than those calculated from the apparent earth pressure diagram suggested for determining strut loads.' (Terzaghi and Peck, 1967).

Since 1969, remarkably few significant modifications to this original work have been adopted in practice. More recently, Sabatini et al (1999) proposed a more detailed design procedure based on the apparent earth pressure approach intended specifically for pre-tensioned, tied-back retaining walls in a comprehensive manual prepared for the US Department of Transportation, Federal Highway Administration. This manual is in wide use within the US and is gaining increasing acceptance within New Zealand and forms the basis for the worked example given below.

Little guidance is available for the design of tied-back retaining walls to resist seismic actions. Gravity retaining walls are normally designed using a pseudo-static approach: the active wedge of soil immediately behind the wall has an additional pseudo-static force component equal to the mass of soil within the wedge multiplied by acceleration. Typically, the resulting forces are resolved to derive a new critical wedge geometry and necessary

wall pressure to achieve equilibrium, as in the Mononobe-Okabe (M-O) theory (Okabe, 1926; Mononobe and Matsuo, 1929).

Kramer (1996) has summarised the limited research available on the performance of tied-back walls during earthquakes. Very few reports of the behaviour of tied back walls during earthquakes are available. Ho et al (1990) surveyed 10 anchored walls in the Los Angeles area following the Whittier earthquake of 1987 and concluded that they performed very well with little or no loss of integrity.

Sabatini et al (1999) recommends the use of the pseudo-static Mononobe-Okabe equations (Okabe, 1926; Mononobe and Matsuo, 1929) to calculate earthquake induced active earth pressures acting against the back face of a tied-back wall. A seismic coefficient from between one-half to two-thirds of the peak horizontal ground acceleration (0.5 PGA to 0.67 PGA) is recommended to provide a wall design that will limit deformations to small values acceptable for highway facilities. The length of the ground anchors may need to be increased beyond that calculated for static design with the anchor bond zone located outside of the Mononobe-Okabe active wedge of soil.

McManus (2009) provides a detailed design procedure for earthquake resistant design of tied-back retaining walls based on the recommendations of Sabatini et al. Numerical analyses of several case studies showed that all of the walls designed using the procedure were robust and would be expected to perform very well, including those designed only to resist gravity loads. In some cases large permanent deformations were calculated (up to 400 mm) but these were for very large earthquakes (scaled peak ground acceleration of 0.6 g). In all cases the walls remained stable with anchor forces safely below ultimate tensile strength. Wall bending moments reached yield in some cases for the extreme earthquakes, but this is considered acceptable provided the wall elements are detailed for ductility.



Walls designed to resist low levels of horizontal acceleration (0.1 g and 0.2 g) showed significant improvements in performance over gravity only designs in terms of permanent displacement for relatively modest increases in cost. Walls designed to resist higher levels of horizontal acceleration (0.3 g and 0.4 g) showed additional improvements in performance but at much greater increases in cost.

The worked example given below uses the detailed procedure of Sabatini et al (1999) 'FHWA procedure' with modifications by McManus (2009) for the earthquake loading case.

Increasingly, practitioners are relying on computer 'black box' software to design tied-back walls with methodologies that range from fully elastic 'beam-on-elastic-foundation' approaches to limiting equilibrium approaches. Caution is required when using 'black box' software to ensure that all possible failure modes have been considered.

**E.1.1 POSSIBLE MODES OF FAILURE**

Possible modes of failure for tied-back retaining walls are illustrated in Figure E.1. A complete design needs to address each of these modes of failure.

- a **Tensile failure of tendon:** The range of tendon loads must be established with suitable margins for safety.
- b **Grout/ground bond failure:** Generally this should always be established on site by proof testing given the difficulty in predicting the capacity and the dependence on installer skill and technique.
- c **Tendon/grout bond failure:** Prevented by reference to proven, commercial anchor details.
- d **Wall bending failure:** Actual wall bending moments are very difficult to predict because of the interaction between soil and structure stiffness and the non-linearity of soil stiffness.

- e **Passive failure at foot of wall:** Insufficient embedment depth for poles leads to passive failure of the soil immediately in front of the wall and instability of the wall and soil mass.
- f **Forward rotation of wall:** Staging of excavation is necessary to prevent forward rotation of wall prior to anchor installation. Wall needs sufficient bending strength to resist cantilever moments for staged excavation. Anchors need to be of sufficient capacity and length to prevent forward rotation.
- g **Bearing failure underneath wall:** Caused by downwards component of anchor force. Check axial capacity of soldier piles, or, bearing capacity of foot of continuous wall. Bearing loads may be reduced by reducing the anchor inclination (15° is a practical minimum).
- h **Failure by overturning:** Essentially same as (f). Anchors need to be of sufficient capacity and length to prevent forward rotation.
- i **Failure by sliding:** Possible mode for cohesionless soils. Factor of safety controlled by increasing depth of embedment of wall and/or poles. Factor of safety calculated using limiting equilibrium 'wedge' analysis.
- j **Failure by rotation:** Possible mode for cohesive soils. Factor of safety controlled by increasing depth of embedment of wall and/or soldier piles. Factor of safety calculated using limiting equilibrium 'Bishop' analysis or similar.

The following procedure addresses each of the above failure modes and is intended to be readily calculated by hand, although use of calculation software such as Mathcad or Excel will be useful for design iterations. The example calculations are made here using Mathcad.

**Figure E.1: Possible modes of failure for tied-back retaining walls (Source: Sabatini et al, 1999)**

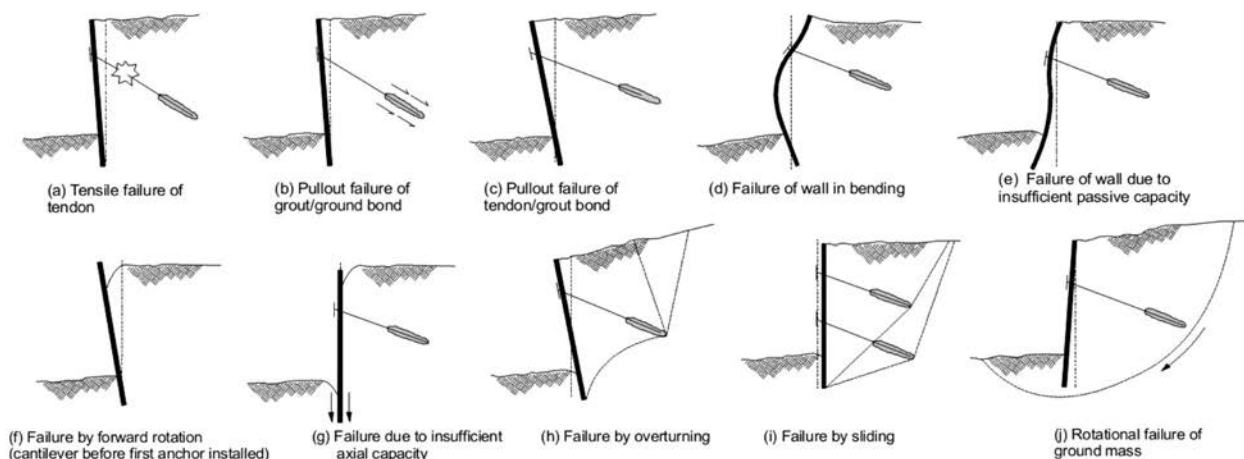

### E.1.2 EXAMPLE WALL

The example wall is shown in Figure E.2 and consists of a 7 m deep excavation to be constructed 'top down' supported by 'soldier' piles with a single row of pre-tensioned ground anchor tie-backs.

The following design assumptions were made:

- › **Soil type:** generic sandy soil
- › **Strength parameters:**  $c = 0$ ,  $\phi = 30^\circ$

#### Comment

These soil parameters were assumed for the purpose of demonstrating the analysis procedure. The designer should determine appropriate parameters based on a site-specific investigation.

- › **Wall situation:** Case 4 (from Table 4.1): Retaining wall protecting adjacent building
- › **Seismic parameters:** Site seismic hazard has been assumed as follows:
  - $a_{\max} = 0.4 g$
  - $A_{\text{topo}} = 1.0$  assuming site is not near cliff edge or ridge top
  - $W_d$  = wall displacement factor, given in Table 5.2 as 0.4 (Case 4 from Table 4.1)

Therefore, from Equation 5-1:

$$k_h = 0.4 \times 1.0 \times 0.4 = 0.16$$

#### Note:

By adopting  $W_d = 0.4$  it is implicitly assumed that the wall and the retained ground are likely to yield and accumulate permanent displacement as a result of the design earthquake. Wall elements including the soldier piles and anchor tendons must be sufficiently robust and ductile to accommodate the displacement.

Figure E.2: Tied-back retaining wall example

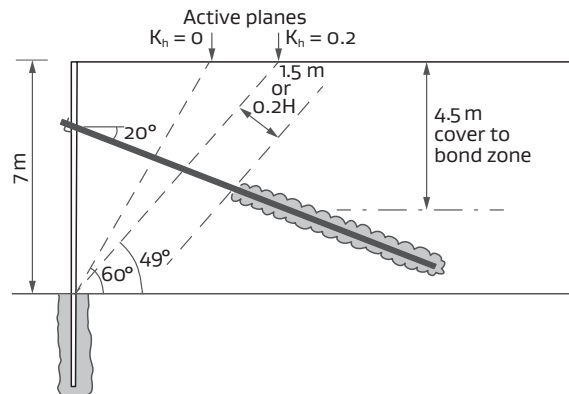

The basic dimensions shown in Figure E.2 were developed as follows:

- › **Distance of anchor from top of wall**  
To be optimised during calculations, see below
- › **Anchor inclination** 15° minimum to permit efficient grouting, 20° required in this case to achieve recommended cover depth of soil over anchor bond zone
- › **Anchor free length:** Minimum = 3 m for bar anchor, 4 m for strand anchor, must extend beyond the failure plane for the active soil wedge (which will be different for the gravity and earthquake cases). For this example, anchor free length = 4 m (see Figure E.2).
- › **Anchor bond length:** To be determined.

#### Step 1. Initial trial geometry

The depth of excavation and depth to each row of anchors needs to be estimated as a first step, based on experience or trial and error.

**Figure E.3: Apparent earth pressure envelope for sand for braced excavation (Terzaghi and Peck, 1967)**

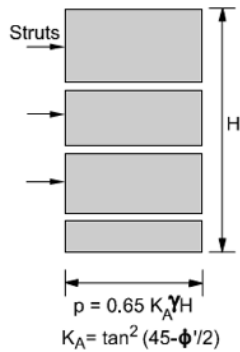

**Figure E.4: Apparent earth pressure diagram for tied-back walls with one level of ground anchors in sand (Source: Sabatini et al, 1999)**

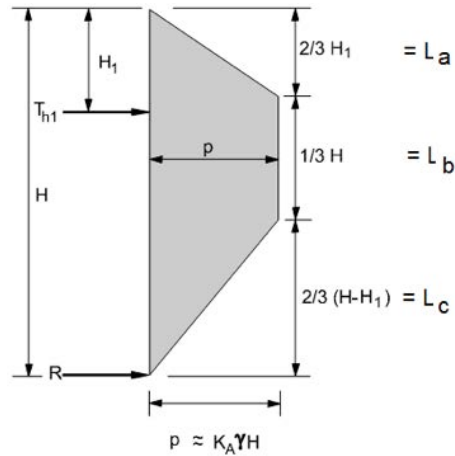

**Step 2. Prepare apparent earth pressure diagram (gravity case)**

The total load acting against the wall from earth pressure for gravity only is based on the earth pressure envelopes recommended by Terzaghi and Peck (1967) (Figure E.3) and modified by Sabatini et al (1999) for tied-back walls (Figure E.4). For the earthquake load case,  $K_A$  should be calculated using the M-O equations as  $K_{AEH}$ . The interface friction angle between the back of the wall and the soil should be conservatively assumed = 0, because the active soil wedge and wall may both move downwards together (ie without any vertical component of friction).

FHWA procedure for single anchor wall in sand

- $H_{wall} := 7 \cdot m$                       Depth of excavation (height of wall)
- $H_1 := 2.2 \cdot m$                       Distance to anchor from top of wall
- $p_v := 5 \cdot \frac{kN}{m^2}$                       Surcharge on active wedge (factored)
- $K_a := 0.33$                               For  $\phi = 30$  degrees
- $\gamma := 18 \cdot \frac{kN}{m^3}$                       Unit weight of retained soil
- $L_s := 1.8 \cdot m$                       Pole spacing

Apparent earth pressure, p  
 $p := K_a \cdot \gamma \cdot H_{wall}$                        $p = 41.6 \frac{kN}{m^2}$

**Step 3. Calculate anchor design load and reaction force required at base of wall (gravity case)**

Overtuning moment about base gives anchor force, T and base reaction, R  
(assuming pinned at base)

$$L_a := 2 \cdot \frac{H_1}{3} \quad L_a = 1.47 \text{ m}$$

$$L_b := \frac{H_{wall}}{3} \quad L_b = 2.33 \text{ m}$$

$$L_c := 2 \cdot \frac{H_{wall} - H_1}{3} \quad L_c = 3.2 \text{ m}$$

$$M_O := p \cdot L_s \cdot \left( \frac{L_c^2}{3} + L_b \cdot \left( \frac{L_b}{2} + L_c \right) + \frac{L_a}{2} \cdot \left( \frac{L_a}{3} + L_b + L_c \right) \right)$$

$$T_{h1} := \frac{M_O}{H_{wall} - H_1} \quad T_{h1} = 281 \text{ kN}$$

$$R := p \cdot L_s \cdot \left( \frac{L_a}{2} + L_b + \frac{L_c}{2} \right) - T_{h1} \quad R = 68.3 \text{ kN}$$

**Step 4. Calculate pole bending moments (gravity case)**

Cantilever pole bending moment at anchor location

$$M_c := p \cdot L_s \cdot \left( \frac{L_a}{2} \cdot \left( \frac{L_a}{3} + \frac{H_1}{3} \right) + \frac{H_1^2}{18} \right) \quad M_c = 87.2 \text{ kN} \cdot \text{m}$$

Maximum pole bending moment below anchor at location of zero shear

$$z_0 := \sqrt{\frac{R \cdot L_c \cdot 2}{p \cdot L_s}} \quad z_0 = 2.42 \text{ m} \quad \text{Height above base for zero SF (max BM)}$$

check  $z_0 < L_c$        $L_c = 3.2 \text{ m}$       OK, else change formula for  $z_0$ ,  $M_{max}$

$$M_{max} := p \cdot L_s \cdot \frac{z_0^3}{L_c \cdot 6} - R \cdot z_0 \quad M_{max} = -110.1 \text{ kN} \cdot \text{m}$$

Optimise pole bending moments by varying  $H_1$

(but also consider increase in deflection for deeper excavation prior to anchor installation)

Pole bending and shear design

$\psi := 1.5$       ULS load factor = 1.5 for earth pressure for gravity case

$$M_{star} := M_{max} \cdot \psi \quad M_{star} = -165 \text{ kN} \cdot \text{m}$$

OR

$$M_{star2} := M_c \cdot \psi \quad M_{star2} = 131 \text{ kN} \cdot \text{m}$$

AND

$$V_{H1} := p \cdot L_s \cdot \left( H_1 - \frac{L_a}{2} \right) \quad V_{H1} = 110 \text{ kN}$$

$$V_{star} := V_{H1} \cdot \psi \quad V_{star} = 165 \text{ kN} \quad \text{Max shear above anchor}$$

OR

$$V_{star2} := (T_{h1} - V_{H1}) \cdot \psi \quad V_{star2} = 257 \text{ kN} \quad \text{Max shear below anchor}$$

**Step 5. Determine depth of pole embedment (gravity case)**

Calculate required depth of embedment for soldier piles to resist wall base reaction using Broms (1965) or similar (see also Wood, 2021).

Pole embedment depth (simple Broms)

- $D := 2.3 \cdot m$  Depth of embedment (trial and error)
- $B := 0.6 \cdot m$  Diameter of pole or concrete encasement
- $K_p := 3$  Simple Rankine for  $\phi = 30$  degrees
- $\Phi_{pp} := 0.5$  Resistance factor, passive pressure
- $H_u := \frac{1}{2} \cdot B \cdot \gamma \cdot 3 \cdot K_p \cdot D^2 = 257 \text{ kN}$  Ultimate lateral resistance (single pole)
- $S_R := \frac{L_s}{B} = 3$  Pole spacing ratio
- $R_S := 0.08 \cdot S_R + 0.6 = 0.84$  Reduction factor for pole spacing  
(see Wood 2021)
- $H_u := H_u \cdot R_S = 216 \text{ kN}$
- $\Phi_{pp} \cdot H_u = 108 \text{ kN}$  check >  $\psi \cdot R = 102 \text{ kN}$  therefore OK

**Step 6. Check internal stability of the wall (gravity case)**

A possible internal failure mechanism is shown in Figure E.5 with an active failure wedge immediately behind the wall, a passive wedge immediately in front of the embedded toe of the wall, and the anchor(s) developing their proven test capacity (normally 1.33 times the design load or 80% of the anchor tensile capacity).

The factor of safety should be  $F_5 > 1.5$  for the gravity case.

**Figure E.5: Internal and external failure mechanisms for tied back walls (Source: Sabatini et al, 1999)**

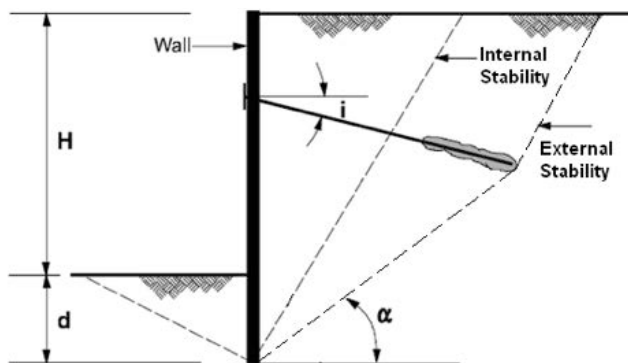

Internal stability check

$$F_H := \frac{T_{h1} \cdot 1.33}{L_s} = 208 \frac{\text{kN}}{\text{m}} \quad \text{ULS anchor horizontal force (proven test capacity)}$$

$$H_{total} := H_{wall} + D = 9.3 \text{ m} \quad \text{Wall height including depth of embedment}$$

$$P_a := K_a \cdot (0.5 \cdot \gamma \cdot H_{total}^2 + p_v \cdot H_{total}) = 272 \frac{\text{kN}}{\text{m}} \quad \text{Active soil thrust (horizontal)}$$

$$K_{ph} := 5.6 \quad \text{NAVFAC chart, } \phi = 30 \text{ deg, } \delta = \phi$$

$$P_p := 0.5 \cdot \gamma \cdot K_{ph} \cdot D^2 = 267 \frac{\text{kN}}{\text{m}}$$

$$H_{net} := P_a - P_p - F_H = -201.989 \frac{\text{kN}}{\text{m}} \quad < 0 \text{ for stability}$$

$$FS := \frac{P_p + F_H}{P_a} = 1.7 \quad > 1.5 \text{ for gravity case (adjust D as required)}$$

**Step 7. Check external stability of the wall (gravity case)**

A possible external failure mechanism is shown in Figure E.5 with a deep-seated failure mechanism completely encompassing the wall and the tie-back anchors. The external stability can be checked by hand calculation or conveniently be assessed using standard limiting equilibrium slope stability software. (Not illustrated in this worked example).

**Step 8. Prepare apparent earth pressure diagram (earthquake case)**FHWA procedure for single anchor wall in sand

$$H_{wall} := 7 \cdot \text{m} \quad \text{Depth of excavation (height of wall)}$$

$$H_1 := 2.2 \cdot \text{m} \quad \text{Distance to anchor from top of wall}$$

$$p_v := 5 \cdot \frac{\text{kN}}{\text{m}^2} \quad \text{Surcharge on active wedge (factored)}$$

$$K_a := 0.44 \quad \text{From M-O eqns: } \phi = 30 \text{ deg, } \delta = 0, \text{ kh} = 0.16$$

$$\gamma := 18 \cdot \frac{\text{kN}}{\text{m}^3} \quad \text{Unit weight of retained soil}$$

$$L_s := 1.8 \cdot \text{m} \quad \text{Pole spacing}$$

Apparent earth pressure, p

$$p := K_a \cdot \gamma \cdot H_{wall} \quad p = 55.4 \frac{\text{kN}}{\text{m}^2}$$

**Step 9. Calculate anchor design load and reaction force required at base of wall (earthquake case)**Overturning moment about base gives anchor force, T and base reaction, R

(assuming pinned at base)

$$L_a := 2 \cdot \frac{H_1}{3} \quad L_a = 1.47 \text{ m}$$

$$L_b := \frac{H_{wall}}{3} \quad L_b = 2.33 \text{ m}$$

$$L_c := 2 \cdot \frac{H_{wall} - H_1}{3} \quad L_c = 3.2 \text{ m}$$

$$M_O := p \cdot L_s \cdot \left( \frac{L_c^2}{3} + L_b \cdot \left( \frac{L_b}{2} + L_c \right) + \frac{L_a}{2} \cdot \left( \frac{L_a}{3} + L_b + L_c \right) \right)$$

$$T_{h1} := \frac{M_O}{H_{wall} - H_1} \quad T_{h1} = 375 \text{ kN}$$

$$R := p \cdot L_s \cdot \left( \frac{L_a}{2} + L_b + \frac{L_c}{2} \right) - T_{h1} \quad R = 91.1 \text{ kN}$$

**Note:**

The earthquake case gives a much greater anchor design load than the gravity case, cf. 281 kN from Step 3.

**Step 10. Calculate pole bending moments (earthquake case)**Cantilever pole bending moment at anchor location

$$M_c := p \cdot L_s \cdot \left( \frac{L_a}{2} \cdot \left( \frac{L_a}{3} + \frac{H_1}{3} \right) + \frac{H_1^2}{18} \right) \quad M_c = 116 \text{ kN} \cdot \text{m}$$

Maximum pole bending moment below anchor at location of zero shear

$$z_0 := \sqrt{\frac{R \cdot L_c \cdot 2}{p \cdot L_s}} \quad z_0 = 2.42 \text{ m} \quad \text{Height above base for zero SF (max BM)}$$

check  $z_0 < L_c$        $L_c = 3.2 \text{ m}$       OK, else change formula for  $z_0$ ,  $M_{max}$ 

$$M_{max} := p \cdot L_s \cdot \frac{z_0^3}{L_c \cdot 6} - R \cdot z_0 \quad M_{max} = -147 \text{ kN} \cdot \text{m}$$

Optimise pole bending moments by varying  $H_1$ 

(but also consider increase in deflection for deeper excavation prior to anchor installation)

Pole bending and shear design $\psi := 1.0$       ULS load factor = 1.0 for earth pressure for earthquake case

$$M_{star} := M_{max} \cdot \psi \quad M_{star} = -147 \text{ kN} \cdot \text{m}$$

OR

$$M_{star2} := M_c \cdot \psi \quad M_{star2} = 116 \text{ kN} \cdot \text{m}$$

AND

$$V_{H1} := p \cdot L_s \cdot \left( H_1 - \frac{L_a}{2} \right) \quad V_{H1} = 146 \text{ kN}$$

$$V_{star} := V_{H1} \cdot \psi \quad V_{star} = 146 \text{ kN} \quad \text{Max shear above anchor}$$

OR

$$V_{star2} := (T_{h1} - V_{H1}) \cdot \psi \quad V_{star2} = 228 \text{ kN} \quad \text{Max shear below anchor}$$

**Note:**

the critical factored bending moment in this case is similar to the gravity case in Step 4, cf. 165 kNm, because the load factor is reduced from 1.5 to 1.0 for the earthquake case.

**Step 11. Determine depth of embedment for soldier piles (earthquake case)**Pole embedment depth (simple Broms)

$D := 2.3 \cdot m$	Depth of embedment (trial and error)
$B := 0.6 \cdot m$	Diameter of pole or concrete encasement
$K_p := 3$	Simple Rankine for $\phi = 30$ degrees
$\Phi_{pp} := 0.5$	Resistance factor, passive pressure
$H_u := \frac{1}{2} \cdot B \cdot \gamma \cdot 3 \cdot K_p \cdot D^2 = 257 \text{ kN}$	Ultimate lateral resistance (single pole)
$S_R := \frac{L_s}{B} = 3$	Pole spacing ratio
$R_S := 0.08 \cdot S_R + 0.6 = 0.84$	
$H_u := H_u \cdot R_S = 216 \text{ kN}$	Reduction factor for pole spacing (see Wood 2021)
$\Phi_{pp} \cdot H_u = 108 \text{ kN}$	check > $\psi \cdot R = 91.1 \text{ kN}$ therefore OK

**Step 12. Check internal stability of the wall (earthquake case)**

The factor of safety for the internal failure mechanism shown in Figure E.5 is checked again for the earthquake case. Displacement of the wall during peak accelerations pulses may stretch the tendon and increase the amount of pre-load in the tendon. Rupture of the tendon is unlikely provided there is sufficient un-bonded free length, and the tendon material is suitably ductile (eg Macalloy 1030 bar is rated at 6 percent minimum elongation, equivalent to 240 mm for the design example with a free length of 4 m)

The factor of safety should be  $FS > 1.1$  for the earthquake case.

Internal stability check

$$F_H := \frac{T_{h1} \cdot 1.33}{L_s} = 277 \frac{\text{kN}}{\text{m}} \quad \text{ULS anchor horizontal force (proven test capacity)}$$

$$H_{total} := H_{wall} + D = 9.3 \text{ m} \quad \text{Wall height including depth of embedment}$$

$$P_a := K_a \cdot (0.5 \cdot \gamma \cdot H_{total}^2 + p_v \cdot H_{total}) = 363 \frac{\text{kN}}{\text{m}} \quad \text{Active soil thrust (horizontal)}$$

$$K_{ph} := 5.6 \quad \text{NAVFAC chart, } \phi = 30 \text{ deg, } \delta = \phi$$

$$P_p := 0.5 \cdot \gamma \cdot K_{ph} \cdot D^2 = 267 \frac{\text{kN}}{\text{m}}$$

$$H_{net} := P_a - P_p - F_H = -180 \frac{\text{kN}}{\text{m}} \quad < 0 \text{ for stability}$$

$$FS := \frac{P_p + F_H}{P_a} = 1.5 \quad > 1.1 \text{ for earthquake case (adjust D as required)}$$



### Step 13. Selection of anchor

The earthquake case was found to govern the calculation of the design load for the anchor, with a required horizontal load of 380 kN @ 1.8 m spacing. A more efficient design might be to provide anchors at 3.6 m centres with short waler beams to spread the load between pairs of soldier piles. For example:

- › Anchor spacing = 3.6 m
- › Anchor inclination angle = 20°
- › Anchor design load = 375 kN x 2 / Cos 20 = 797 kN each
- › Anchor test load = 797 x 1.33 = 1060 kN
- › Anchor minimum characteristic tensile strength = 1060/0.8 = 1325 kN (ie maximum test load = 0.8 x anchor characteristic tensile strength).

Refer to FHWA guidelines for more advice or BS 8081: 1989

### Step 14. External stability check

The external stability case (refer to Figure E.5) is controlled by the total length of the ground anchor and should be checked once the anchor length has been determined. A wedge analysis may be undertaken using hand calculations or proprietary slope stability software used.

### OTHER ISSUES

The global stability of the wall and surrounds may need to be checked in certain cases, eg where the ground in front of the retaining wall is sloping away. Also where there is weak ground below or in front of the toe of the wall.

The axial resistance of the poles acting as load bearing piles may need to be checked in some cases, eg where the anchor forces are very high or steeply inclined, and where the ground below the pole foundations is weak.

## References

- Broms, B.B. (1965). 'Design of Laterally Loaded Piles.' *Journal of the Soil Mechanics and Foundations Division, ASCE*, Vol. 91, No. SM3, Proceedings Paper 4342, pp. 79-99.
- McManus, K.J. 2009. 'Earthquake Resistant Design of Tied-Back Retaining Structures', *Proc. Tech Conf. N.Z. Soc. for Earthquake Engineering*, Christchurch, NZ, March 2009.
- Mononobe, N. and Matsuo, H. (1929). 'On the determination of earth pressures during earthquakes,' *Proceedings, World Engineering Congress*, 9p.
- Okabe, S. (1926). 'General theory of earth pressures,' *Journal of the Japan Society of Civil Engineering*, Vol. 12, No. 1.
- Peck, R.B. (1969). 'Deep Excavations and Tunneling in Soft Ground, State of Art Report.' *Proceedings of the 7th International Conference on Soil Mechanics and Foundation Engineering*, Mexico City, Mexico, pp. 225-290.
- Sabatini, P.J., Pass, D.G., and Bachus, R.C. (1999). 'Ground anchors and anchored systems,' *Geotechnical Circular No. 4, FHWA-IF-99-015*, Federal Highway Administration, Department of Transportation, Washington DC.
- Terzaghi, K. and Peck, R.B. (1967). *Soil Mechanics in Engineering Practice, 2nd. Ed.*, Wiley, New York, 729 p.
- Wood, J.H., 2021. 'Cantilever Pole Retaining Walls', *NZ Geomechanics News* June 2021, Issue 101, NZGS.

## Appendix F. Application of mononobe-okabe equations with high acceleration and/or high back-slope angle

Common wisdom among engineers states that the M-O equations cannot be used to calculate values of  $K_{ae}$  for retaining walls with high back-slope angles. Above certain values of acceleration,  $k_h$ , the equations have no real solutions. The higher the back-slope angle relative to the friction angle of the soil, the lower the value of  $k_h$  for which a real solution is possible.

A similar situation exists for gravity only cases (ie  $k_h = 0$ ) with no solution for  $K_a$  possible where the back-slope angle exceeds the soil friction angle. This latter case has a simple physical explanation because the slope angle for a cohesionless soil cannot exceed the angle of repose which is equal to the soil friction angle. Efforts to increase the slope angle above the angle of repose will result in a shallow slope failure, with soil sloughing to the bottom of the slope until the angle of repose is restored. For the case where the back-slope angle,  $i$ , is exactly equal to the soil friction angle,  $\Phi$ , the M-O equations give a real solution for  $K_a$ , for example:

$$\begin{aligned} i &= 30 \text{ deg} \\ \phi &= 30 \text{ deg} \\ \delta &= 0 \text{ deg} \\ \rho &= 30 \text{ deg} \\ K_a &= 0.75 \end{aligned}$$

where  $\delta$  = interface friction angle at the back of the wall and  $\rho$  = angle of inclination of the failure plane behind the wall. The failure plane angle is equal to the slope inclination angle (both  $30^\circ$  in this case) and the resulting value for  $K_a$  may be interpreted as the minimum soil pressure required to stabilise an 'infinite slope' failure behind the wall. (An 'infinite slope' failure may be defined as a shallow slope failure with a planar failure surface parallel to the ground surface, and with the depth of the failure plane being much less than the length of the failure plane.)

The value for  $K_a$  depends also on the interface friction angle between the soil and the back face of the wall. For the case where  $\delta = \phi$ :

$$\begin{aligned} i &= 30 \text{ deg} \\ \phi &= 30 \text{ deg} \\ \delta &= 30 \text{ deg} \\ \rho &= 30 \text{ deg} \\ K_a &= 0.866 \end{aligned}$$

Now consider the case of a retaining wall with back-slope angle = 0 (ie level ground) under acceleration,  $k_h$ . For moderate levels of acceleration, the M-O equations give real values for  $K_{ae}$ , becoming greater in value for greater levels of  $k_h$ . Above a certain critical acceleration, however, no real solution is possible for  $K_{ae}$ . This critical acceleration is found to be equal to  $\tan(\phi)$ , for which a real solution may be found by considering the limit as  $k_h \rightarrow \tan(\phi)$ :

$$\begin{aligned} kh &= 0.577 \\ i &= 0 \text{ deg} \\ \phi &= 30 \text{ deg} \\ \delta &= 30 \text{ deg} \\ \rho &= 8.993 \times 10^{-4} \text{ deg} \\ K_{ae} &= 1.333 \end{aligned}$$

In the limit,  $k_h \rightarrow \tan(\phi)$  and  $\rho \rightarrow 0$ , ie the M-O equations predict that the inclination of the failure surface is parallel with the ground surface, similar to the 'infinite slope' failure for the case of steeply inclined backfill. The value for  $K_{ae}$  in this case may similarly be interpreted as the minimum soil pressure required to stabilise an 'infinite slope' failure behind the wall, where the 'infinite slope' in this case is horizontal.

For a non-cohesive soil, the horizontal acceleration cannot be increased beyond  $k_h = \tan(\phi)$  because the soil shear strength along a horizontal failure surface has already been fully mobilised, ie the retained soil is effectively 'base isolated' from higher horizontal ground accelerations. Therefore, the limiting value obtained for  $K_{ae}$  (1.333 in the example) might be considered the maximum possible active soil pressure (for  $\phi = 30^\circ$  and  $\delta = 0$ ).

For both of the above cases, the retained soil has reached a state of 'general fluidization' (Richards et al 1990). Any attempt to place loads on the soil surface, for instance by placing additional soil to steepen the slope, will fail because the soil will simply 'flow', very much like a viscous fluid, until the stable slope angle is restored. The minimum or 'active' soil pressure required to stabilise the respective 'infinite slope' will not change. Increasing the soil pressure applied by the retaining wall will not change the stability of the slope nor increase the maximum slope angle possible in either case.

For the first case (where  $i = \phi$ ), applying any horizontal acceleration will have the effect of destabilising the slope. The slope will no longer be in equilibrium and soil must flow until the slope angle is reduced to a new angle that is stable under the acceleration. The active soil pressure required to stabilise the new, stable, 'infinite slope' angle is able to be calculated using the M-O equations. The wedge of soil material temporarily located above the new, stable slope angle is irrelevant to the calculation of active soil pressure for the retaining wall, just as placing soil onto the surface of a lake has no effect on the fluid pressure acting against a dam.

For any given horizontal acceleration  $k_h$ , the corresponding stable, 'infinite slope' angle may be calculated as  $i = \phi - \tan^{-1}(k_h)$ . A real value for  $K_{ae}$  may be calculated for these values of  $k_h$  and  $i$  and represents the maximum value for  $K_{ae}$  for that value of  $k_h$  for all slope angles. Sample charts have been calculated and are shown below. (Note:  $K_{ae}$  collapses to  $K_a$  when  $k_h = 0$ ).

## References

- Mononobe, N. and Matsuo, H. (1929). 'On the determination of earth pressure during earthquakes.' Proc. World Engineering Conference, Vol. 9, pp. 177–185
- Okabe, S. (1926). 'General theory of earth pressure,' J. Japanese Society of Civil Engineers, Tokyo, Japan, Vol 12. No.1
- Richards, R., Jr., Elms, D.G., and Budhu, M. (1990). 'Dynamic Fluidization of Soils,' J. Geotechnical Engineering, Vol. 116, No.5, pp. 740–759.

**Walls with vertical back-face ( $\beta = 0$ ), no interface friction ( $\delta = 0$ ):**

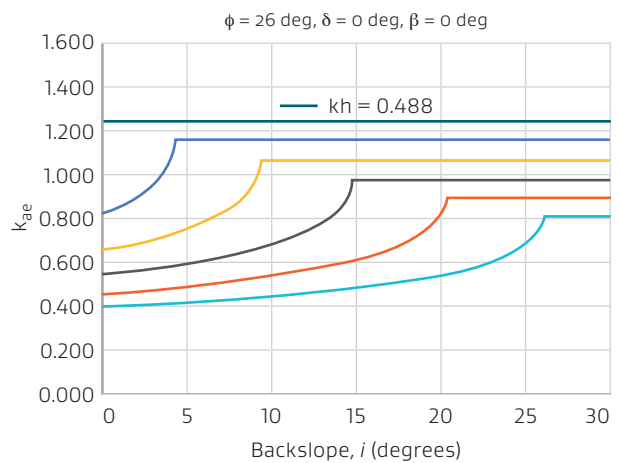
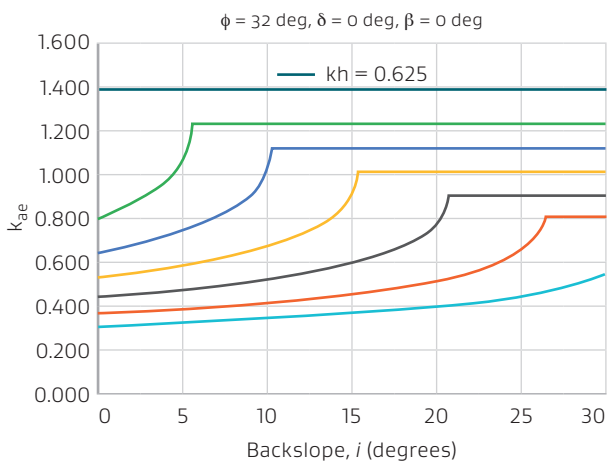
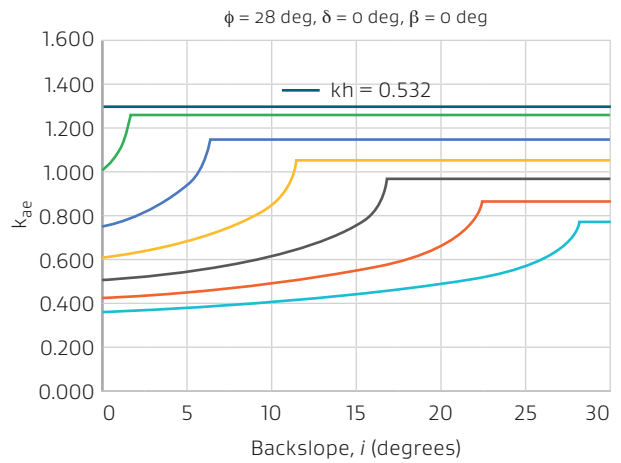
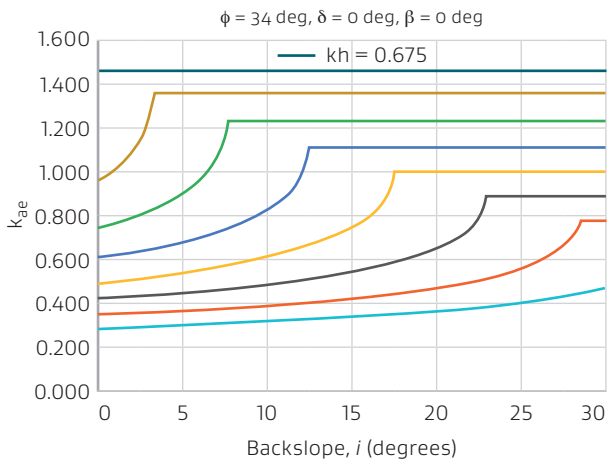
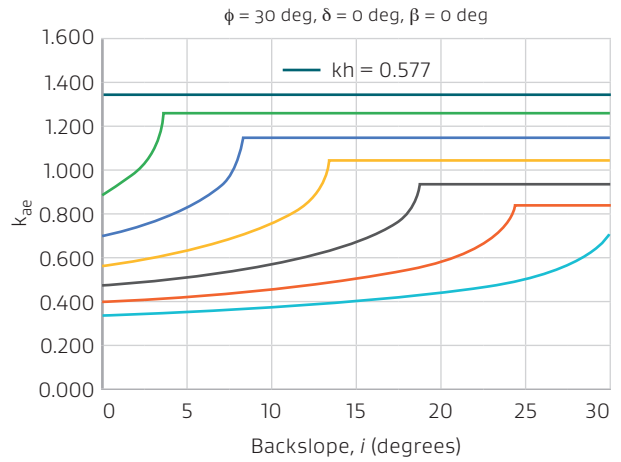
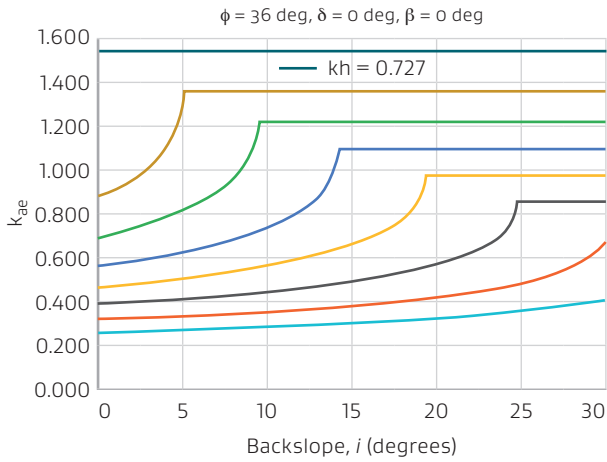

**Key**

- kh = 0
- kh = 0.1
- kh = 0.2
- kh = 0.3
- kh = 0.4
- kh = 0.5
- kh = 0.6

**Walls with vertical back-face ( $\beta = 0$ ), full interface friction ( $\delta = \phi$ ):**

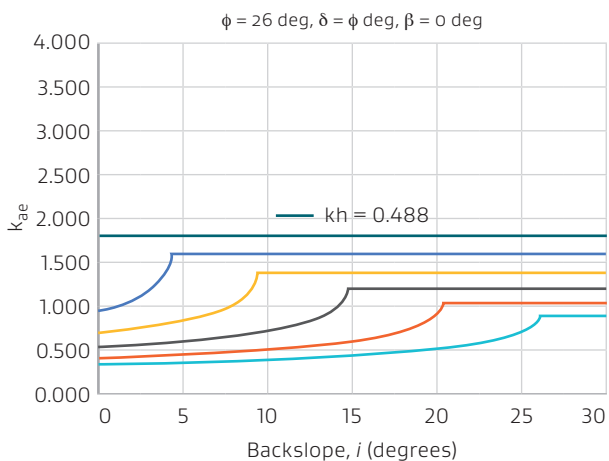
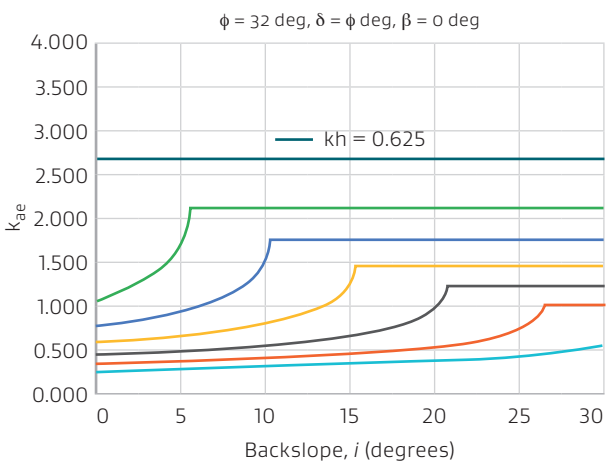
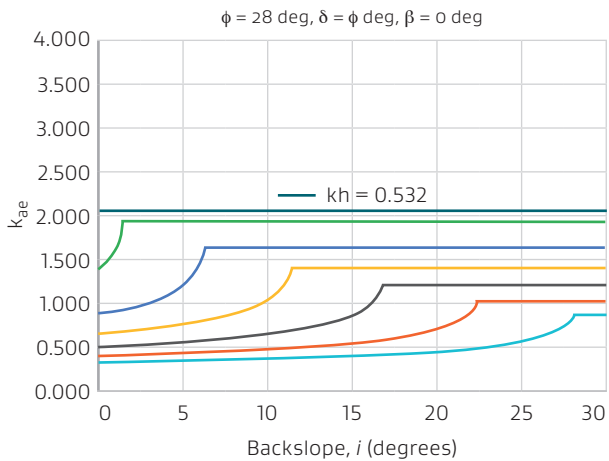
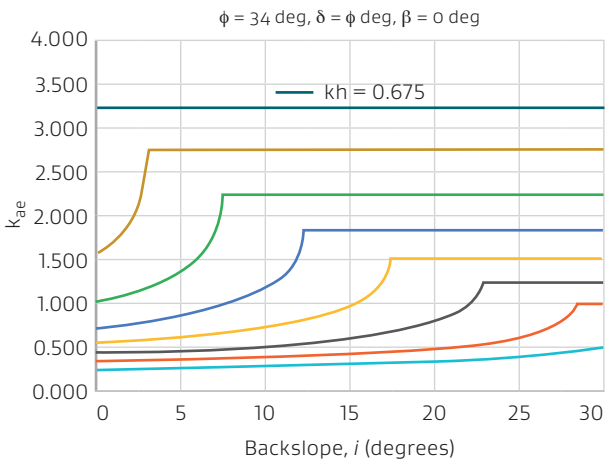
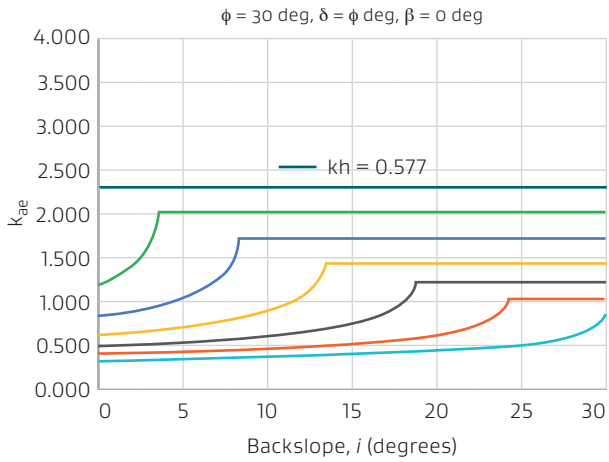
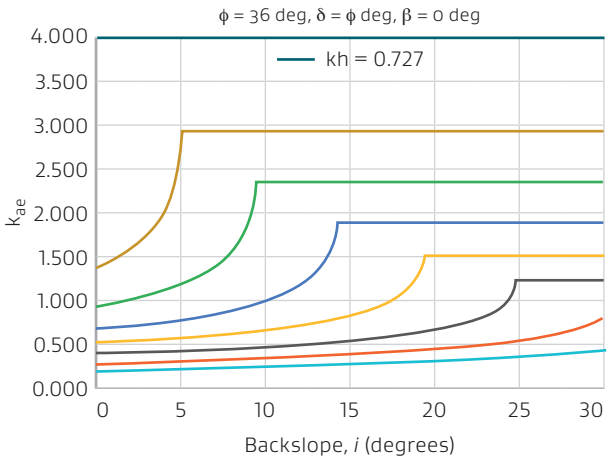

- Key**
- kh = 0
  - kh = 0.1
  - kh = 0.2
  - kh = 0.3
  - kh = 0.4
  - kh = 0.5
  - kh = 0.6

**Walls with backwards sloping back-face ( $\beta = -14$  deg), intermediate interface friction ( $\delta = 2\phi/3$ )**

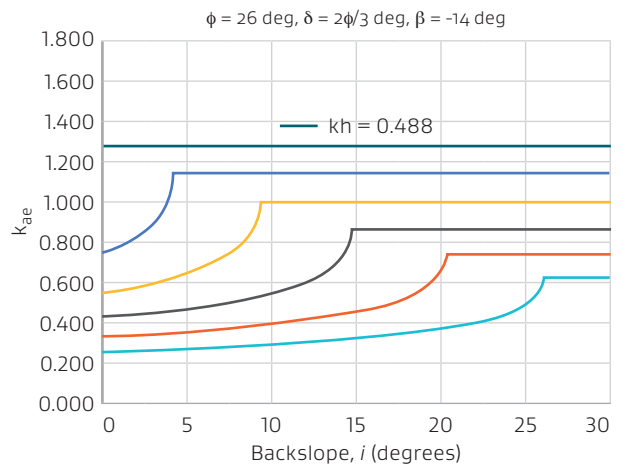
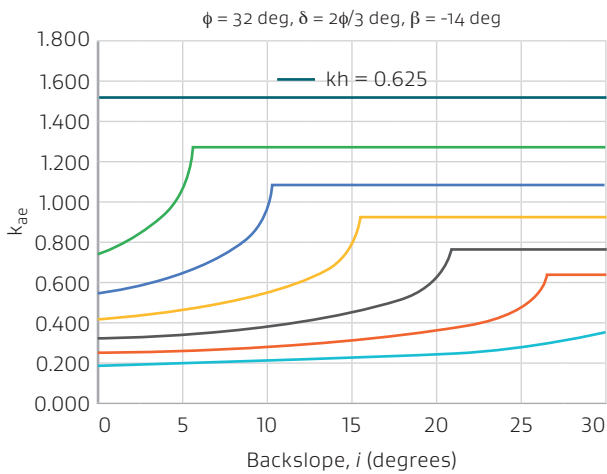
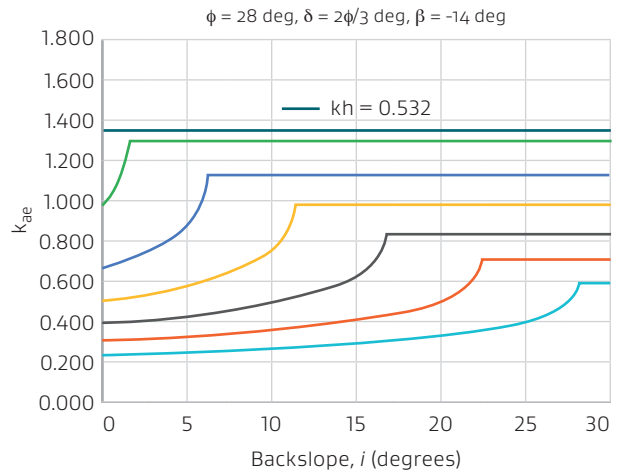
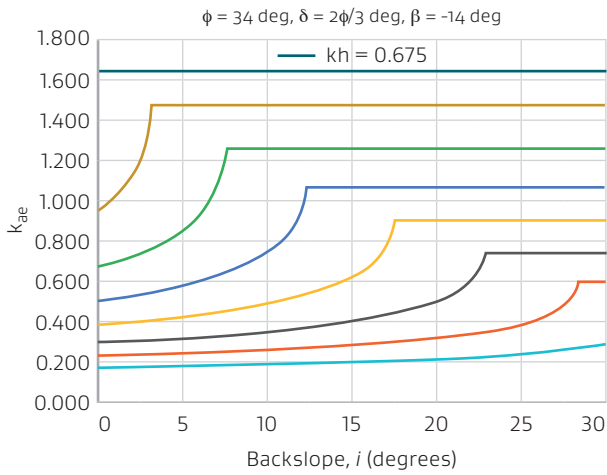
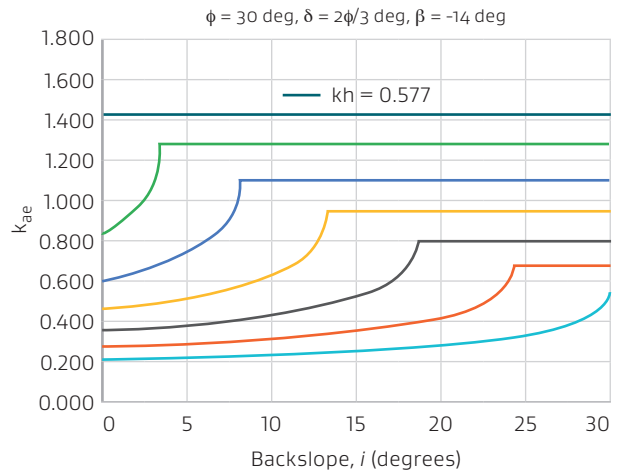
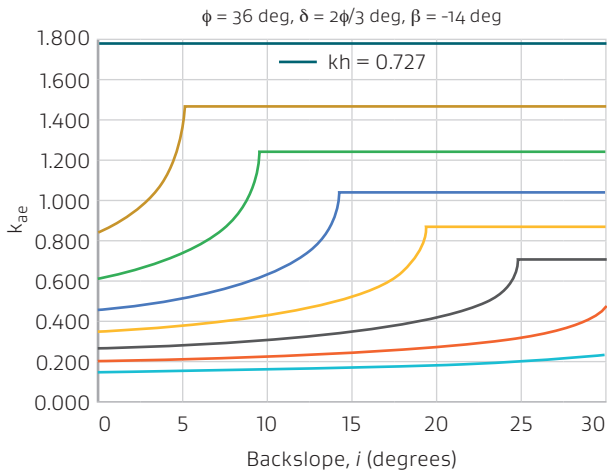

**Key**

- $kh = 0$
- $kh = 0.1$
- $kh = 0.2$
- $kh = 0.3$
- $kh = 0.4$
- $kh = 0.5$
- $kh = 0.6$



